

# User Manual

Revision 1.001  
English

## RS232 / Optic Fiber - Converter

(Order Code: HD67072-B2)

## RS485 / Optic Fiber - Converter

(Order Code: HD67073-B2)

## USB / Optic Fiber - Converter

(Order Code: HD67074-B2)

for Website information:

[www.adfweb.com?Product=HD67072](http://www.adfweb.com?Product=HD67072)

for Price information:

[www.adfweb.com?Price=HD67072-B2](http://www.adfweb.com?Price=HD67072-B2)

[www.adfweb.com?Price=HD67073-B2](http://www.adfweb.com?Price=HD67073-B2)

[www.adfweb.com?Price=HD67074-B2](http://www.adfweb.com?Price=HD67074-B2)

### Benefits and Main Features:

- ▶ EMI/RFI and transient immunity
- ▶ Data Rates up to 115200 bps
- ▶ 2 km (1.24 miles ) distance range
- ▶ Industrial temperature range:  
-40°C / 85°C (-40°F / 185°F)



HD67072-B2, HD67073-B2, HD67074-B2

### Analyzer / Scanner /Sniffer, M-Bus

[www.adfweb.com?Product=HD67031](http://www.adfweb.com?Product=HD67031)

### Multi-Drop Converter RS232/RS485 to Optic Fiber

[www.adfweb.com?Product=HD67033M](http://www.adfweb.com?Product=HD67033M) (RS232, SL)

[www.adfweb.com?Product=HD67034M](http://www.adfweb.com?Product=HD67034M) (RS232, DL)

[www.adfweb.com?Product=HD67035M](http://www.adfweb.com?Product=HD67035M) (RS485, SL)

[www.adfweb.com?Product=HD67036M](http://www.adfweb.com?Product=HD67036M) (RS485, DL)

### Isolator & Repeater, RS485

[www.adfweb.com?Product=HD67149-A1](http://www.adfweb.com?Product=HD67149-A1)

### GSM I/O and Alarms Modem

[www.adfweb.com?Product=HD67302](http://www.adfweb.com?Product=HD67302)

### CAN, CANopen, J1939, DeviceNet, NMEA2000 Analyzer

[www.adfweb.com?Product=HD67316](http://www.adfweb.com?Product=HD67316)

### CAN, CANopen, J1939, DeviceNet, NMEA2000 from/to USB

[www.adfweb.com?Product=HD67390](http://www.adfweb.com?Product=HD67390)

Do you have an your customer protocol?

See the following links:

[www.adfweb.com?Product=HD67003](http://www.adfweb.com?Product=HD67003)

Do you need to choose a device? do you want help?

Ask it to the following link:

[www.adfweb.com?Cmd=helpme](http://www.adfweb.com?Cmd=helpme)

**INDEX:**

	Page
INDEX	2
UPDATED DOCUMENTATION	2
REVISION LIST	2
WARNING	2
TRADEMARKS	2
SECURITY ALERT	3
CONNECTION SCHEME	4
CHARACTERISTICS	7
POWER SUPPLY	8
FUNCTION MODES	9
LEDS	10
RS232	11
RS485	12
USB	12
BAUDRATE/PARITY/STOP BIT	13
FIBER OPTIC FUNCTION	14
UPDATING FIRMWARE	15
MECHANICAL DIMENSIONS	16
ORDER CODES	16
ACCESSORIES	16
DISCLAIMER	17
OTHER REGULATIONS AND STANDARDS	17
WARRANTIES AND TECHNICAL SUPPORT	18
RETURN POLICY	18
PRODUCTS AND RELATED DOCUMENTS	18

**UPDATED DOCUMENTATION:**

Dear customer, we thank you for your attention and we remind you that you need to check that the following document is:

- Updated
- Related to the product you own

To obtain the most recently updated document, note the "document code" that appears at the top right-hand corner of each page of this document.

With this "Document Code" go to web page [www.adfweb.com/download/](http://www.adfweb.com/download/) and search for the corresponding code on the page. Click on the proper "Document Code" and download the updates.

To obtain the updated documentation for the product that you own, note the "Document Code" (Abbreviated written "Doc. Code" on the label on the product) and download the updated from our web site [www.adfweb.com/download/](http://www.adfweb.com/download/)

**REVISION LIST:**

Revision	Date	Author	Chapter	Description
1.000	25/08/2011	FI	All	First release version (v1.000)
1.001	15/02/2013	Nt	All	Added new chapters

**WARNING:**

ADFweb.com reserves the right to change information in this manual about our product without warning.

ADFweb.com is not responsible for any error this manual may contain.

**TRADEMARKS:**

All trademarks mentioned in this document belong to their respective owners.

**SECURITY ALERT:****GENERAL INFORMATION**

To ensure safe operation, the device must be operated according to the instructions in the manual. When using the device are required for each individual application, legal and safety regulation. The same applies also when using accessories.

**INTENDED USE**

Machines and systems must be designed so the faulty conditions do not lead to a dangerous situation for the operator (i.e. independent limit switches, mechanical interlocks, etc.).

**QUALIFIED PERSONNEL**

The device can be used only by qualified personnel, strictly in accordance with the specifications.

Qualified personnel are persons who are familiar with the installation, assembly, commissioning and operation of this equipment and who have appropriate qualifications for their job.

**RESIDUAL RISKS**

The device is state of the art and is safe. The instrument can represent a potential hazard if they are inappropriately installed and operated by personnel untrained. These instructions refer to residual risks with the following symbol:

 This symbol indicates that non-observance of the safety instructions is danger for people to serious injury or death and / or the possibility of damage.

**CE CONFORMITY**

The declaration is made by us. You can send an email to [support@adfweb.com](mailto:support@adfweb.com) or give us a call if you need it.

**CONNECTION SCHEME:**

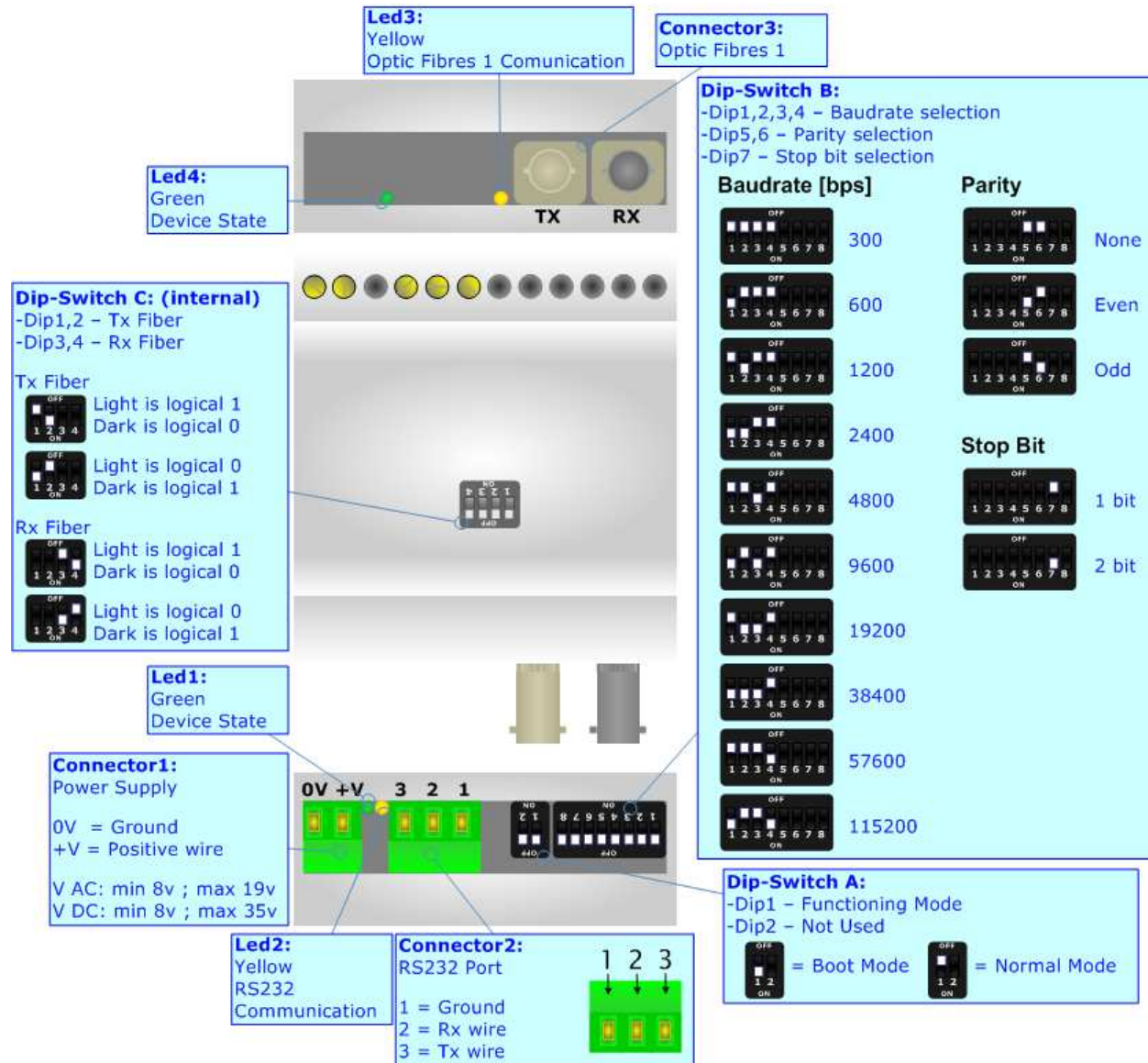

Figure 1: Connection scheme for HD67072-B2

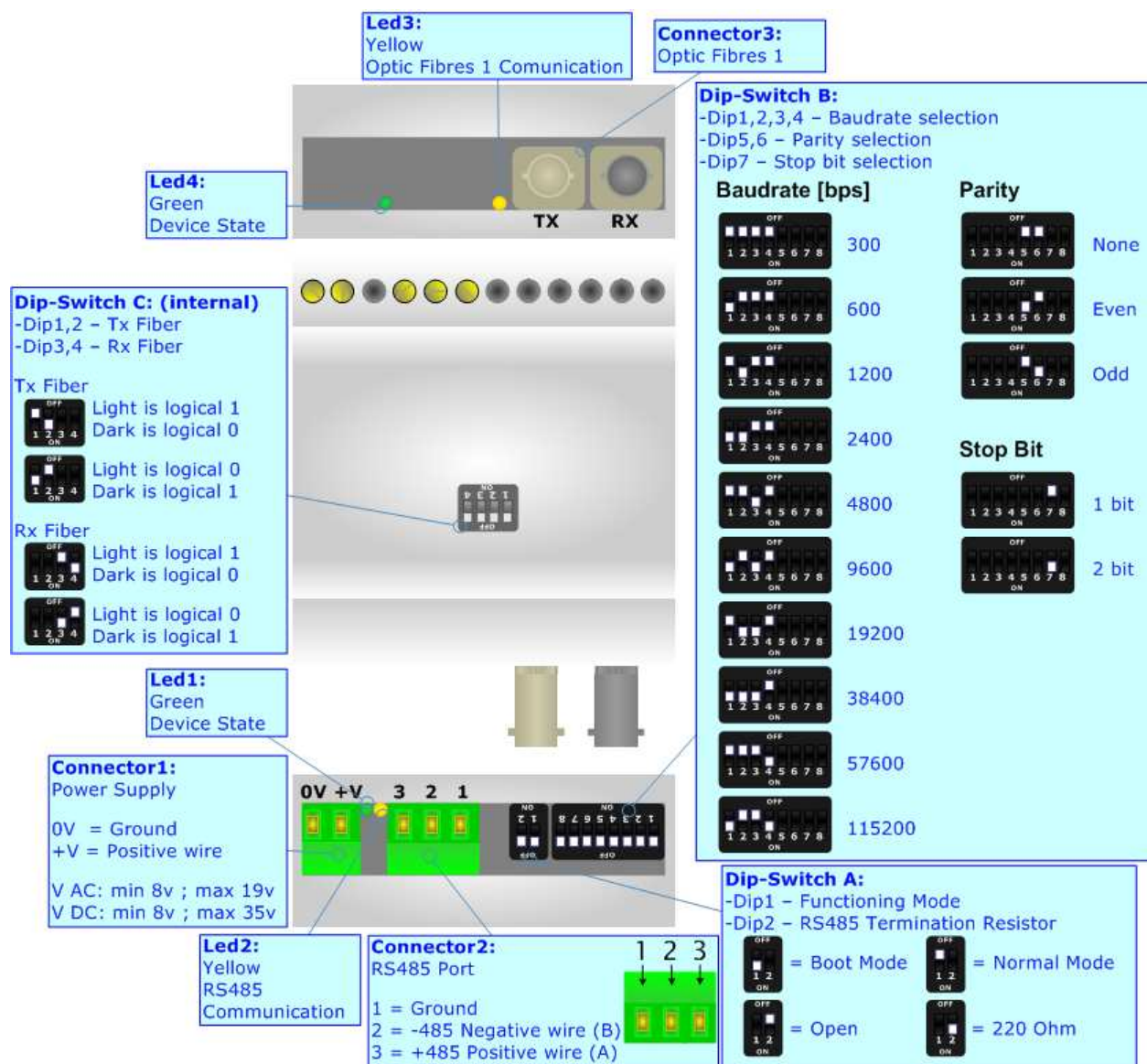

Figure 2: Connection scheme for HD67073-B2

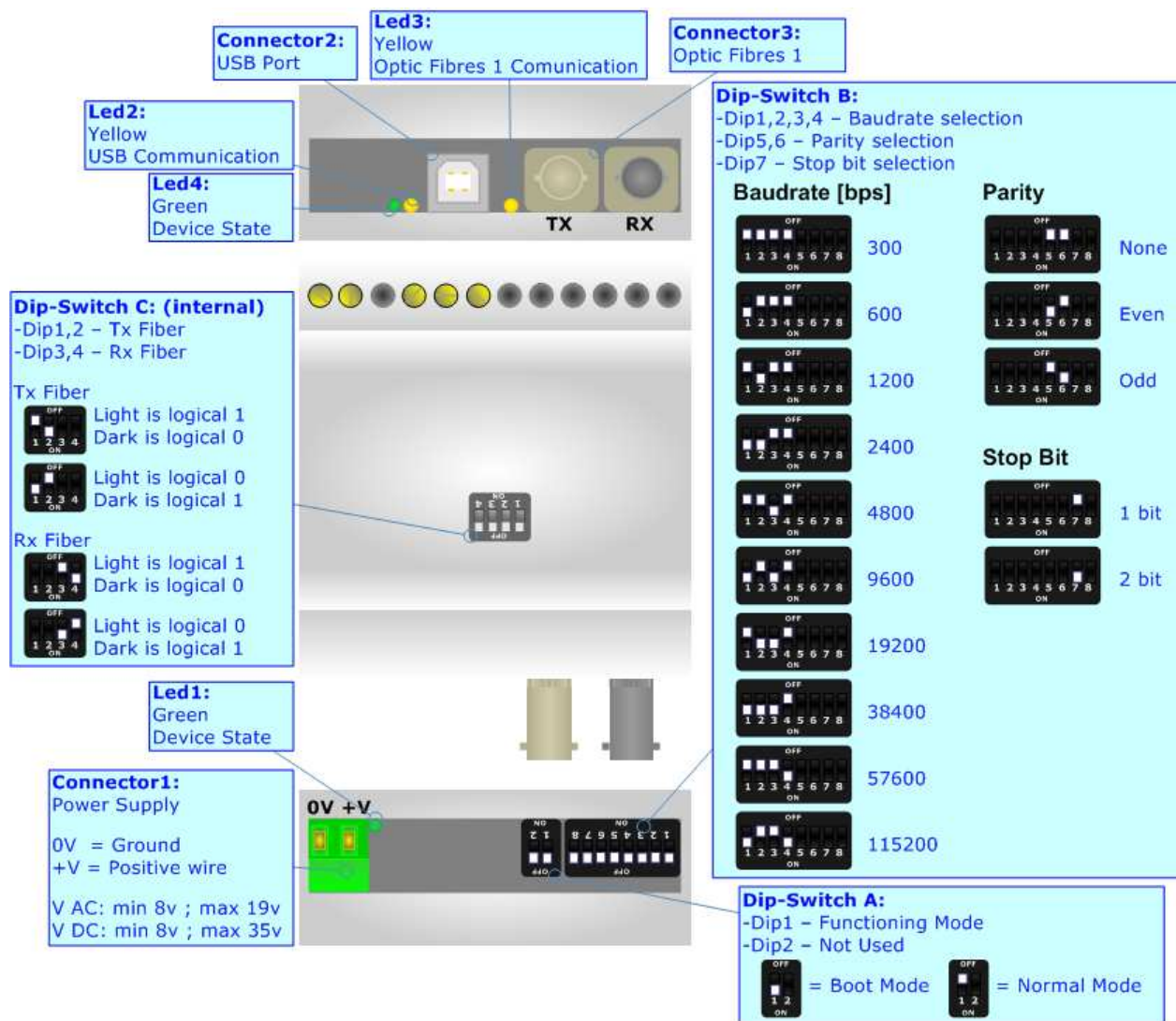

Figure 3: Connection scheme for HD67074-B2

**CHARACTERISTICS:**

Standards can be mixed and matched so RS-232 devices can be connected to RS-485 devices, or USB devices can communicate with RS485 devices, or RS232 devices can communicate with USB replacing a converter and isolator.

Fiber lines are inherently resistant to EMI/RFI and transient surges, so they are ideal for data communications near heavy electrical equipment and other electrical or radio interference.

Usually the 'Idle State' (logical 1) is when the light of fiber is ON, while the converter it is possible also to invert this so you can have that the 'Idle State' (logical 1) is when the light of fiber is OFF.

These devices allow the following characteristics:

- Same baudrate at copper (RS232/RS485/USB) side and fiber optic side selectable by Dip-Switches;
- Mountable on 35mm Rail DIN;
- Baud rate, Parity and Stop Bit of Serial (RS232/RS485/USB) and Fiber Optic changeable with Dip-Switch;
- Industrial temperature range -40°C / 85°C.

**POWER SUPPLY:**

The device can be powered at 8...19V AC and 8...35V DC. For more details see the two tables below.

VAC		VDC	
Vmin	Vmax	Vmin	Vmax
8V	19V	8V	35V

Consumption at 24V DC:

Device	W/VA
HD67072-B2, HD67073-B2, HD67074-B2	4



**Caution: Not reverse the polarity power**

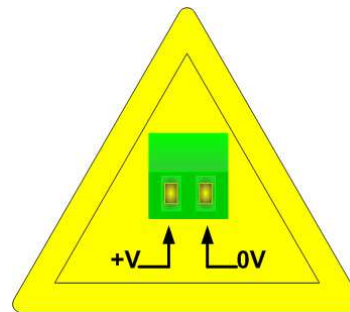

HD6707X-B2



**Note:** The HD67074-B2 device cannot be fed only by the USB port (Connector2), it is necessary to use an external power supply on 'Connector1'.

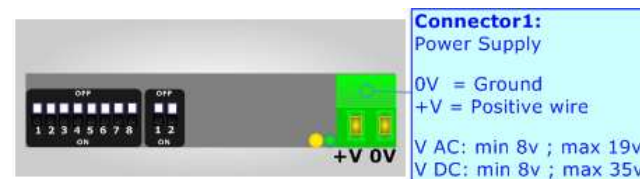
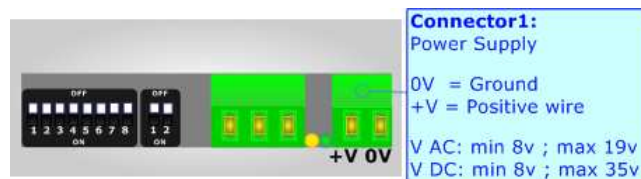



**FUNCTION MODES:**

The device has got two functions mode depending of the position of the Dip1 of 'Dip-Switch A':

- The first, with Dip1 in Off position (factory setting), is used for the normal working of the device.
- The second, with Dip1 in On position, is used for upload the Project.

For the operations to follow for the updating (see 'UPDATING FIRMWARE' section).

According to the functioning mode, the LEDs will have specifics functions (see 'LEDS' section).

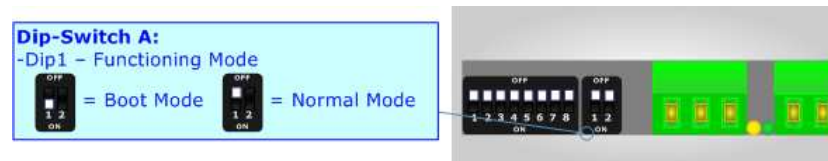

**LEDS:**

The device has got four LEDs that are used to give information of the functioning status. The various meanings of the LEDs are described in the table below.

LED	Normal Mode	Boot Mode
1: Device State	Blinks slowly	Blinks quickly
2: RS232 Communication RS485 Communication USB Communication	<b>OFF:</b> No data is arriving to the port <b>Blinks:</b> Some data is arriving to the port	Blinks quickly
3: Optic Fibres 1 Communication	<b>OFF:</b> No data is arriving to the port <b>Blinks:</b> Some data is arriving to the port	Blinks quickly
4: Device State	Blinks slowly	Blinks quickly

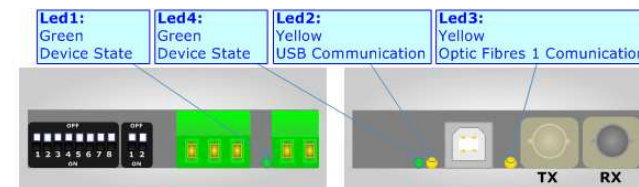
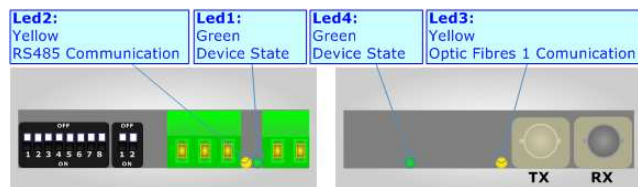
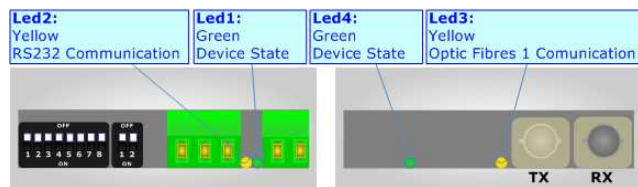

**RS232:**

The connection from RS232 socket to a serial port must be made with a cable with these characteristics:

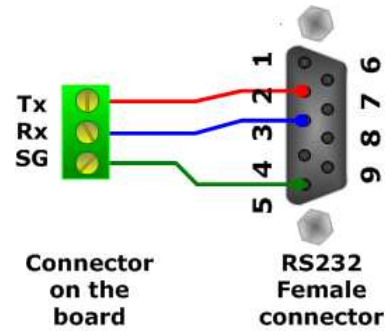

It is recommended that the cable not exceed 15 meters.

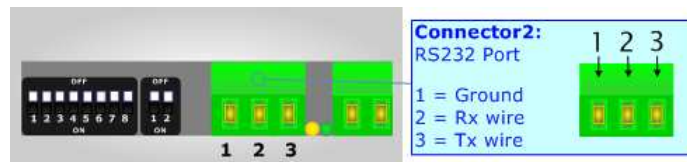

**RS485:**

The connection from the RS485 socket to the Personal Computer for updating the program must be made with a converter RS485 to USB or RS485 to RS232. For more details see the following links:

- [www.adfweb.com?Product=HD67118](http://www.adfweb.com?Product=HD67118) for the RS232 to RS485 converter;
- [www.adfweb.com?Product=HD67119](http://www.adfweb.com?Product=HD67119) for the RS485 to USB converter.

For terminate the RS485 line with a 220Ω resistor it is necessary that the Dip2 of Dip-Switch A is at ON position.



**USB:**

The USB connector (Connector2) of HD67074-B2 is a Type-B Female. So the cable must be a Type-B Male.



**BAUDRATE/PARITY/STOP BIT:**

Acting on 'Dip-Switch B' it is possible to change the Baudrate, Parity and number of Stop Bit of the serial line and the fiber optic line.

- From Dip 1 to Dip 4 it is possible to set the Speed of the Serial line according to the following table:

Speed [bps]	Dip 1	Dip 2	Dip 3	Dip 4
300	OFF	OFF	OFF	OFF
600	ON	OFF	OFF	OFF
1200	OFF	ON	OFF	OFF
2400	ON	ON	OFF	OFF
4800	OFF	OFF	ON	OFF
9600	ON	OFF	ON	OFF
19200	OFF	ON	ON	OFF
38400	ON	ON	ON	OFF
57600	OFF	OFF	OFF	ON
115200	ON	OFF	OFF	ON

- With Dip 5 and Dip 6 it is possible to set the Parity of the Serial line according to the following table:

Parity	Dip 5	Dip 6
None	OFF	OFF
Odd	ON	OFF
Even	OFF	ON

- With Dip 7 it is possible to set the Stop Bit of the Serial line according to the following table:

Stop Bit	Dip 7
One	OFF
Two	ON

**Dip-Switch B:**  
 -Dip1,2,3,4 - Baudrate selection  
 -Dip5,6 - Parity selection  
 -Dip7 - Stop bit selection



**FIBER OPTIC FUNCTION:**

By acting on 'Dip-Switch C' it is possible to select for each fiber, Tx and Rx, the logical state of 0 and 1. This Dip-Switch is inside the device, so you have to remove the top cover and act on the switches.

Usually the 'Idle State' (logical 1) is when the light of fiber is ON, so you have to put the Dip 1 and 3 at Off and Dip 2 and 4 at On (these are also the Factory Settings). It is possible to invert this so you can have that the 'Idle State' (logical 1) when the light of fiber is OFF, so you have to put the Dip 2 and 4 at Off and Dip 1 and 3 at On. It is possible to give different settings to the two fibers.

The connector of the fiber optic must be ST model; the fiber type must be a Multi-Modal fiber of 62.5/125µm. The maximum length of the fiber must be 2000 m (1.24 miles).

The data rates of the fiber is the same of copper line (RS232/RS485/USB).

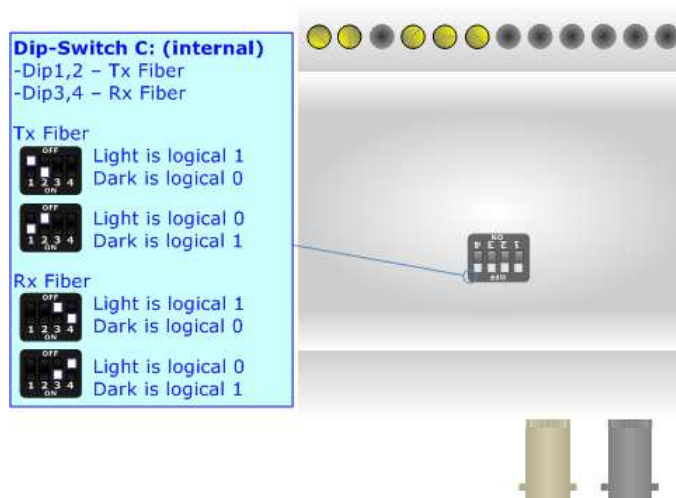

Is strictly prohibited to set all dip at ON or OFF position. The change must be made when the device is OFF.

## UPDATING FIRMWARE:

It is possible to update the Firmware of the device. For doing that, it is necessary to download from this link, [www.adfweb.com/download/filefold/SW67072.zip](http://www.adfweb.com/download/filefold/SW67072.zip), the program, install it and follow these instructions:

- Turn off the Device;
- Connect the RS232/RS485/USB cable (depending on the code of the device) form your PC to the Gateway;
- Put the Dip1 of Dip-Switch A at ON position (For more info see Figs. 1,2,3);
- Select the COM port and press the "Init" button;
- Turn on the device;
- Check the Leds. All must blink quickly (For more info see Figs. 1,2,3);
- Press the "Update Firmware" button;
- Wait than the progress bar is full and appears "Progress: Update Done" and then turn off the device;
- Put the Dip1 of Dip-Switch A at OFF position;
- Turn on the device.

At this point the firmware on the device is correctly updated.



### Warning:

If the "Progress: Update Done" doesn't appears when you try to do the Update before require assistance try these points:

- Check if the serial COM port selected is the correct one;
- Check if the serial is connected between the PC and the device;
- Try to repeat the operations for the updating;
- If you are using a dongle try with a native COM port or change the dongle;
- Try with another PC;
- Try to restart the PC.

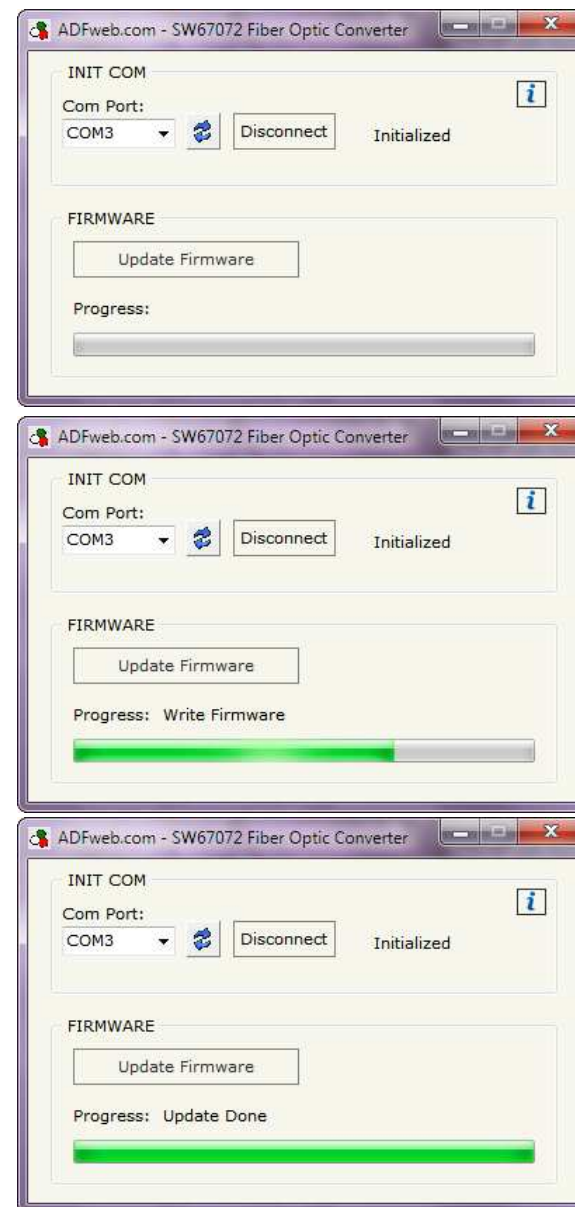

**MECHANICAL DIMENSIONS:**

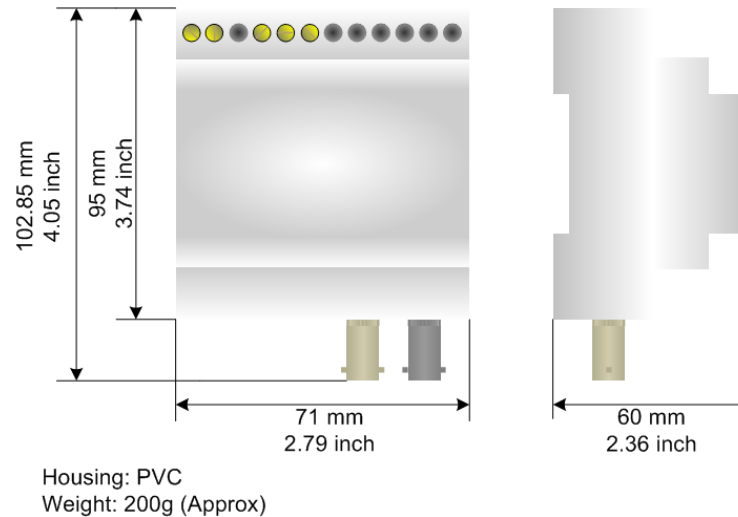

Figure 5: Mechanical dimensions scheme for HD67072-B2, HD67073-B2, HD67074-B2

**ORDER CODES:**

- Order Code: **HD67072-B2** - RS232 / Optic Fiber - Converter
- Order Code: **HD67073-B2** - RS485 / Optic Fiber - Converter
- Order Code: **HD67074-B2** - USB / Optic Fiber - Converter

**ACCESSORIES:**

- Order Code: **AC34001** - Rail DIN - Power Supply 220/240V AC 50/60Hz – 12 V AC
- Order Code: **AC34002** - Rail DIN - Power Supply 110V AC 50/60Hz – 12 V AC
- Order Code: **AC34021** - Patch Cable Optic Fibres ST/ST 2 Mts
- Order Code: **AC34022** - Patch Cable Optic Fibres ST/ST 10 Mts
- Order Code: **AC34107** - Null Modem Cable Fem/Fem DSub 9 Pin 1,5 m
- Order Code: **AC34114** - Null Modem Cable Fem/Fem DSub 9 Pin 5 m



## DISCLAIMER

All technical content within this document can be modified without notice. The content of the document content is a recurring audit. For losses due to fire, earthquake, third party access or other accidents, or intentional or accidental abuse, misuse, or use under abnormal conditions repairs are charged to the user. ADFweb.com S.r.l. will not be liable for accidental loss of use or inability to use this product, such as loss of business income. ADFweb.com S.r.l. shall not be liable for consequences of improper use.

## OTHER REGULATIONS AND STANDARDS

### WEEE INFORMATION



Disposal of old electrical and electronic equipment (as in the European Union and other European countries with separate collection systems).

This symbol on the product or on its packaging indicates that this product may not be treated as household rubbish. Instead, it should be taken to an applicable collection point for the recycling of electrical and electronic equipment. If the product is disposed correctly, you will help prevent potential negative environmental factors and human health, which could otherwise be caused by inappropriate disposal. The recycling of materials will help to conserve natural resources. For more information about recycling this product, please contact your local city office, your household waste disposal service or the shop where you purchased the product.

### RESTRICTION OF HAZARDOUS SUBSTANCES DIRECTIVE



The device respects the 2002/95/EC Directive on the restriction of the use of certain hazardous substances in electrical and electronic equipment (commonly referred to as Restriction of Hazardous Substances Directive or RoHS).

### CE MARKING



The product conforms with the essential requirements of the applicable EC directives.

**WARRANTIES AND TECHNICAL SUPPORT:**

For fast and easy technical support for your ADFweb.com SRL products, consult our internet support at [www.adfweb.com](http://www.adfweb.com). Otherwise contact us at the address support@adfweb.com

**RETURN POLICY:**

If while using your product you have any problem and you wish to exchange or repair it, please do the following:

- 1) Obtain a Product Return Number (PRN) from our internet support at [www.adfweb.com](http://www.adfweb.com). Together with the request, you need to provide detailed information about the problem.
- 2) Send the product to the address provided with the PRN, having prepaid the shipping costs (shipment costs billed to us will not be accepted).

If the product is within the warranty of twelve months, it will be repaired or exchanged and returned within three weeks. If the product is no longer under warranty, you will receive a repair estimate.

**PRODUCTS AND RELATED DOCUMENTS:**

Part	Description	URL
HD67031	Analyzer / Scanner / Sniffer M-Bus	<a href="http://www.adfweb.com?product=HD67031">www.adfweb.com?product=HD67031</a>
HD67117	CAN bus Repeater	<a href="http://www.adfweb.com?product=HD67117">www.adfweb.com?product=HD67117</a>
HD67119	Converter USB 2.0 to RS485 Isolated	<a href="http://www.adfweb.com?product=HD67119">www.adfweb.com?product=HD67119</a>
HD67302	GSM I/O and Alarms Modem	<a href="http://www.adfweb.com?Product=HD67302">www.adfweb.com?Product=HD67302</a>
HD67316	CAN, CANopen, J1939, DeviceNet, NMEA2000 Analyzer	<a href="http://www.adfweb.com?Product=HD67316">www.adfweb.com?Product=HD67316</a>