

User Manual

Revision 2.003
English

RS232 / Ethernet - Converter

(Order Code: HD67038-2-A1 HD67038-2-B2)

RS485/ Ethernet - Converter

(Order Code: HD67038-5-A1 HD67038-5-B2)

RS422/ Ethernet - Converter

(Order Code: HD67038-4-A1)

RS485 / RS232 / Ethernet - Converter

(Order Code: HD67038-25-A1 HD67038-25-B2)

RS422 / RS232 / Ethernet - Converter

(Order Code: HD67038-24-A1)

For Website information:

www.adfweb.com?Product=HD67038

For Price information:

www.adfweb.com?Price=HD67038

Benefits and Main Features:

- ⊕ Triple electrical isolation
- ⊕ Protocol independent, suitable for supervision software
- ⊕ Temperature range: -40°C/+85°C (-40°F/+185°F)



For others products, see also the following links:

RS232 / RS485 - Converter

www.adfweb.com?Product=HD67118

USB / RS485 - Converter

www.adfweb.com?Product=HD67119

RS485 – Isolator – Repeater – Extender bus line

www.adfweb.com?Product=HD67149-A1

EtherNet/IP / Serial - Converter

www.adfweb.com?Product=HD67590

Do you have your customer protocol? Then go to:

www.adfweb.com?Product=HD67003

Do you need to choose a device? Do you want help?

www.adfweb.com?Cmd=helpme



User Manual

INDEX:

	Page
INDEX	2
UPDATED DOCUMENTATION	2
REVISION LIST	2
WARNING	2
TRADEMARKS	2
SECURITY ALERT	3
EXAMPLE OF CONNECTION	4
CONNECTION SCHEME	7
CHARACTERISTICS	15
CONFIGURATION	15
POWER SUPPLY	16
FUNCTION MODES	17
LEDS	18
ETHERNET	19
RS422	19
RS485	20
RS232	20
USE OF COMPOSITOR SW67038	21
NEW CONFIGURATION / OPEN CONFIGURATION	22
SOFTWARE OPTIONS	23
DEVICE SETTING	24
Op. MODALITY REMOTE COM PORT	25
Op. MODALITY TUNNEL POINT TO POINT	27
Op. MODALITY TUNNEL POINT TO MULTIPOINT (BROADCAST)	29
Op. MODALITY TUNNEL POINT TO MULTIPOINT (KEEP ALIVE)	31
UPDATE VIA SERIAL	33
UPDATE VIA UDP	34
CHANGE BAUD AND PARITY ON THE FLY	36
ACTIVE SERIAL DRIVER	37
MECHANICAL DIMENSIONS	39
ORDERING INFORMATIONS	40
DISCLAIMER	41
OTHER REGULATIONS AND STANDARDS	41
WARRANTIES AND TECHNICAL SUPPORT	42
RETURN POLICY	42

UPDATED DOCUMENTATION:

Dear customer, we thank you for your attention and we remind you that you need to check that the following document is:

- ✚ Updated
- ✚ Related to the product you own

To obtain the most recently updated document, note the “document code” that appears at the top right-hand corner of each page of this document.

With this “Document Code” go to web page www.adfweb.com/download/ and search for the corresponding code on the page. Click on the proper “Document Code” and download the updates.

REVISION LIST:

Revision	Date	Author	Chapter	Description
2.000	20/02/2014	Fl	All	New hardware version
2.001	28/07/2014	Fl	All	Revision
2.002	13/05/2015	Fl	All	Revision
2.003	12/05/2017	Ff	All	Revision

WARNING:

ADFweb.com reserves the right to change information in this manual about our product without warning.

ADFweb.com is not responsible for any error this manual may contain.

TRADEMARKS:

All trademarks mentioned in this document belong to their respective owners.

SECURITY ALERT:**GENERAL INFORMATION**

To ensure safe operation, the device must be operated according to the instructions in the manual. When using the device, legal and safety regulation are required for each individual application. The same applies also when using accessories.

INTENDED USE

Machines and systems must be designed so the faulty conditions do not lead to a dangerous situation for the operator (i.e. independent limit switches, mechanical interlocks, etc.).

QUALIFIED PERSONNEL

The device can be used only by qualified personnel, strictly in accordance with the specifications.

Qualified personnel are persons who are familiar with the installation, assembly, commissioning and operation of this equipment and who have appropriate qualifications for their job.

RESIDUAL RISKS

The device is state-of-the-art and is safe. The instruments can represent a potential hazard if they are inappropriately installed and operated by untrained personnel. These instructions refer to residual risks with the following symbol:



This symbol indicates that non-observance of the safety instructions is a danger for people that could lead to serious injury or death and / or the possibility of damage.

CE CONFORMITY

The declaration is made by our company. You can send an email to support@adfweb.com or give us a call if you need it.

EXAMPLES OF CONNECTION:

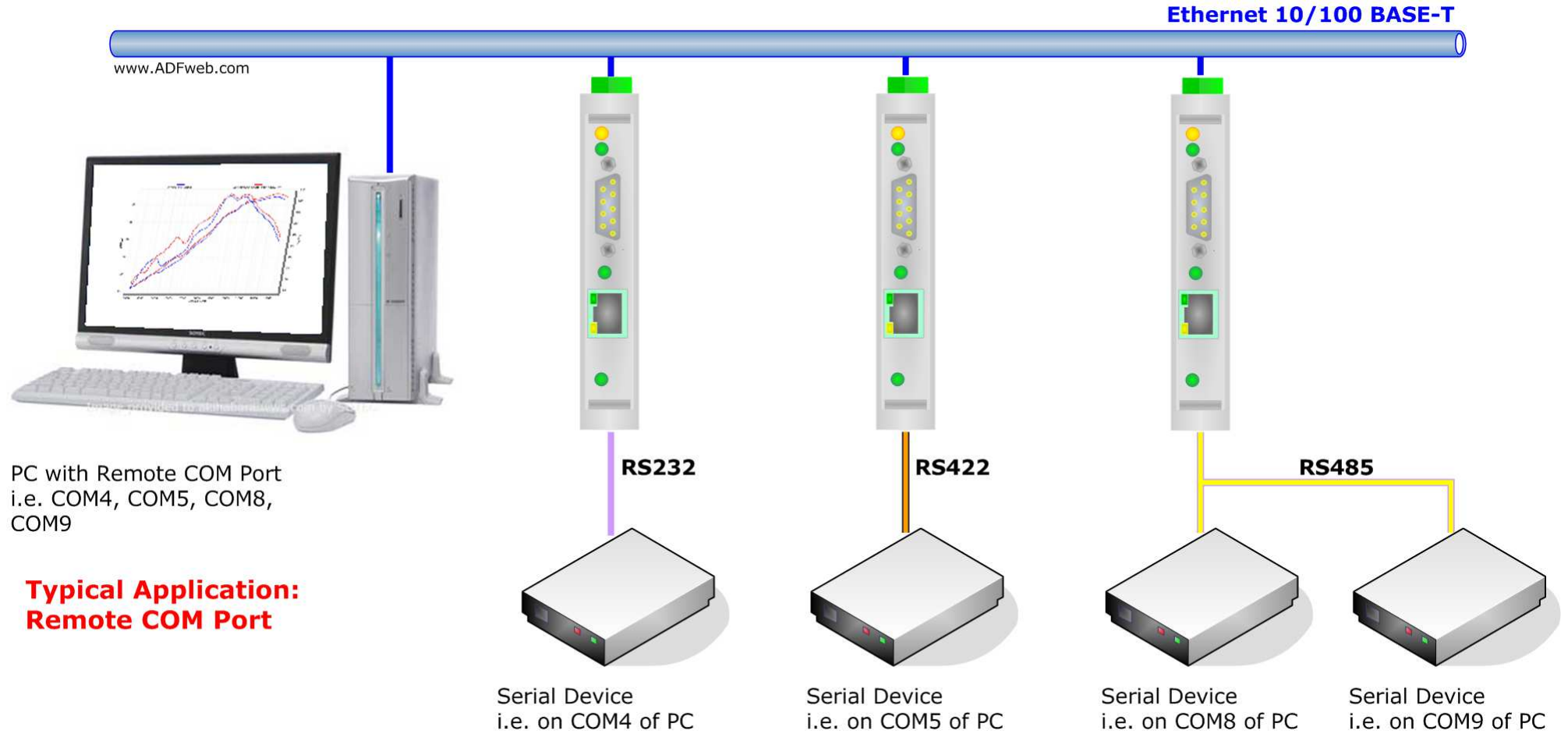

Note: This solution allows also an internet connection of the device; so the PC and one or more HD67038-xx-A1 / HD67038-xx-B2 can be connected together through Internet.

**Typical Application:
 Tunnel Point to MultiPoint**

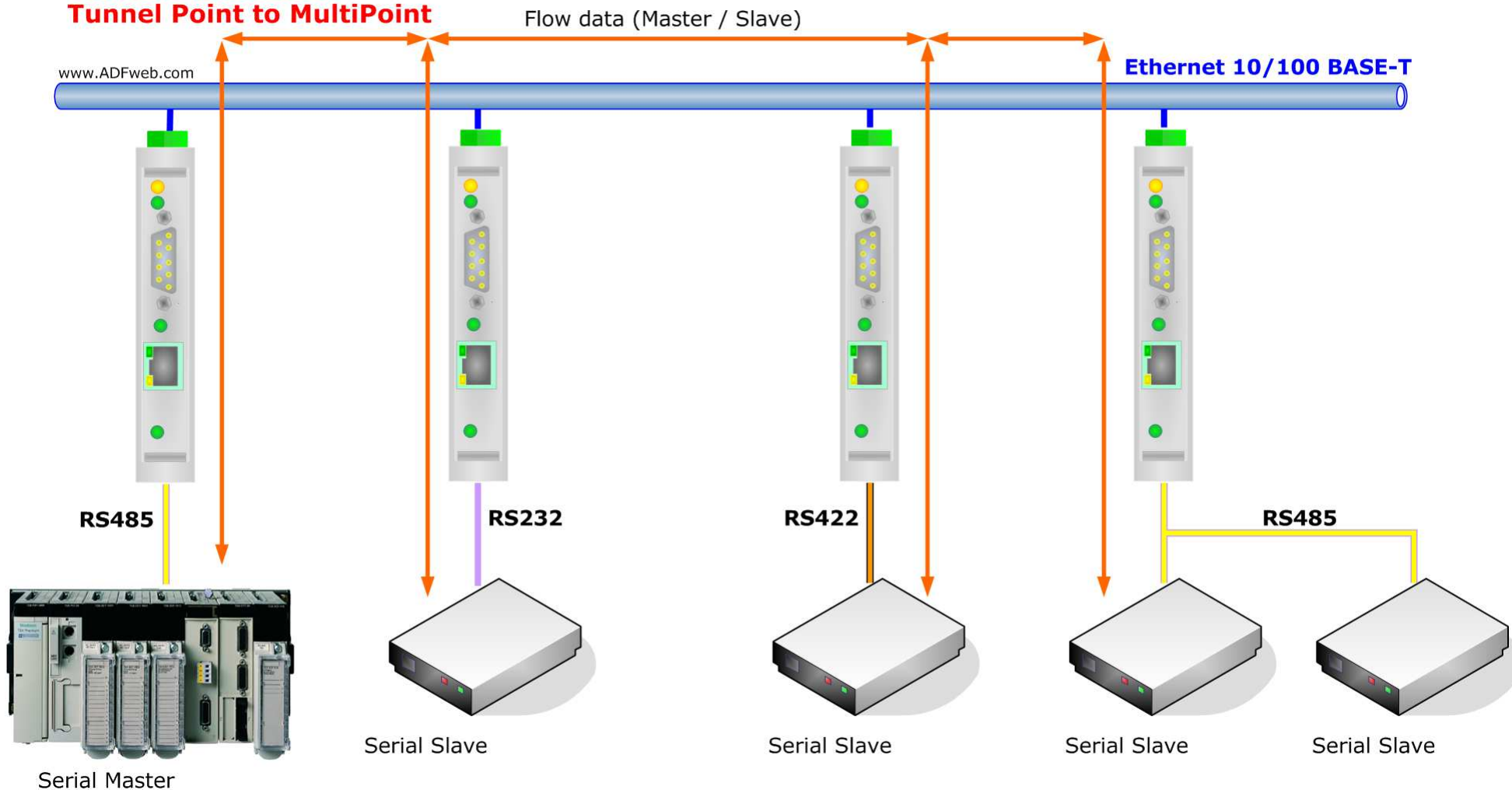

Note: This solution allows also an internet connection of the device; so the PC and one or more HD67038-xx-A1 / HD67038-xx-B2 can be connected together through Internet.

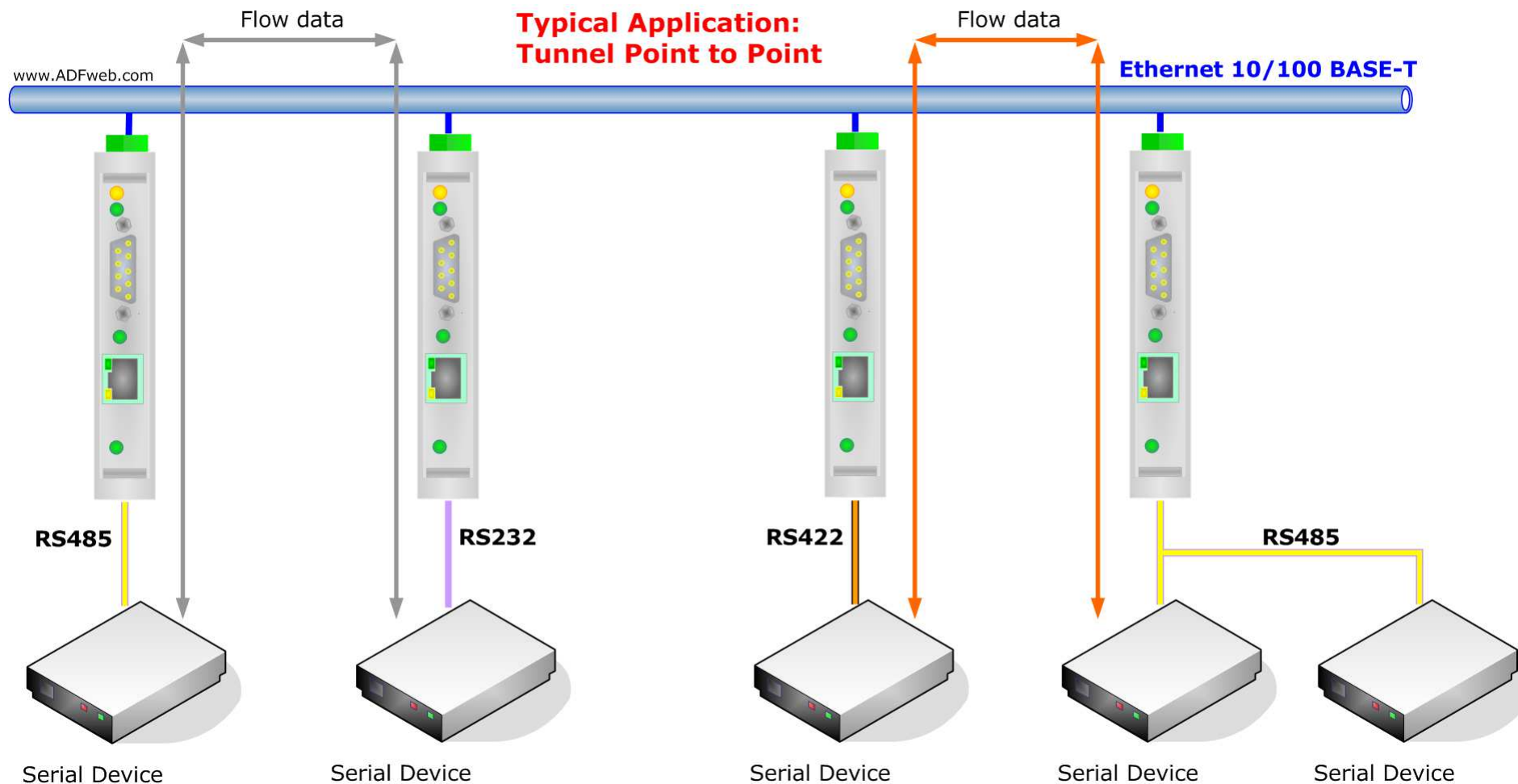

Note: This solution allows also an internet connection of the device; so the PC and one or more HD67038-xx-A1 / HD67038-xx-B2 can be connected together through Internet.

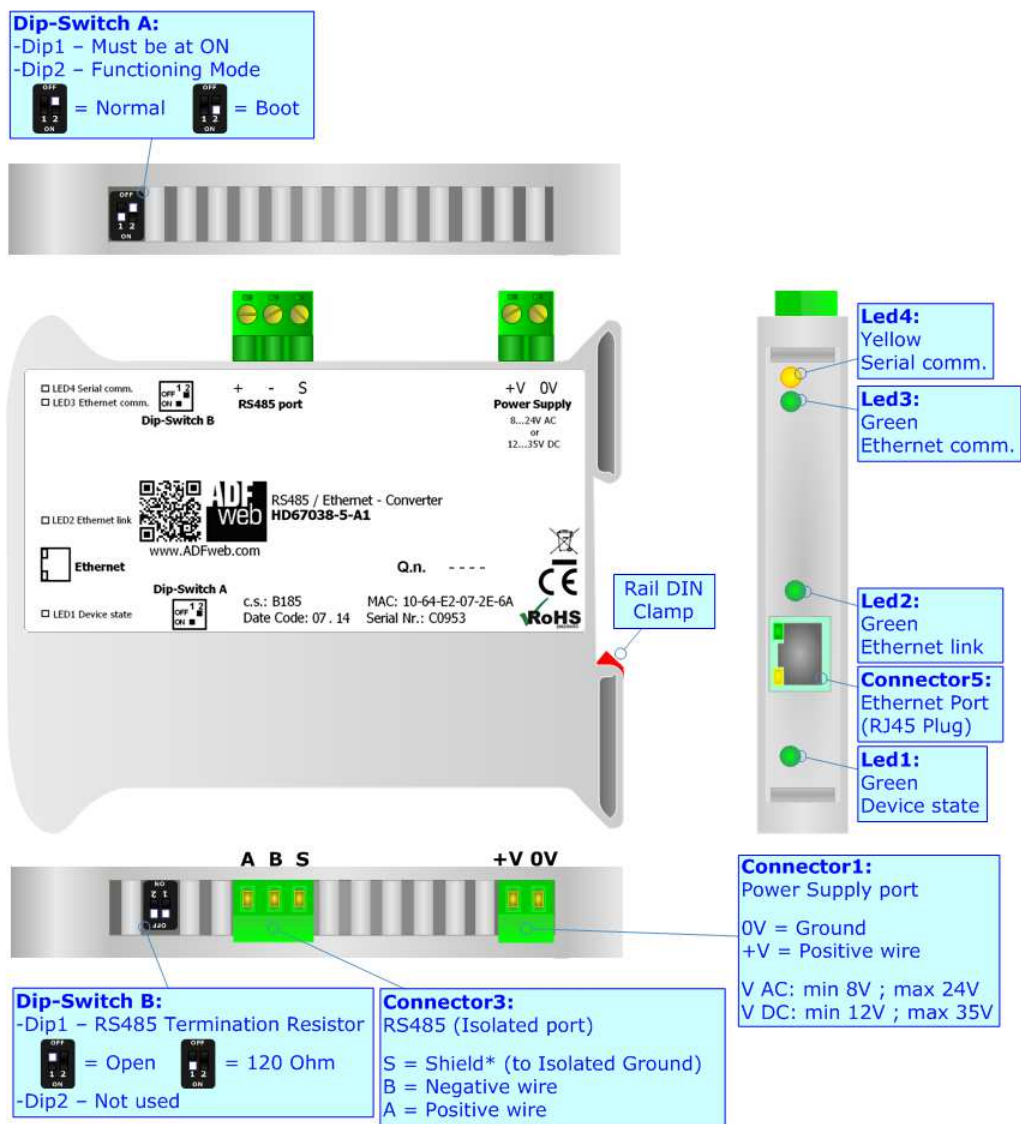

Figure 1b: Connection scheme for HD67038-5-A1

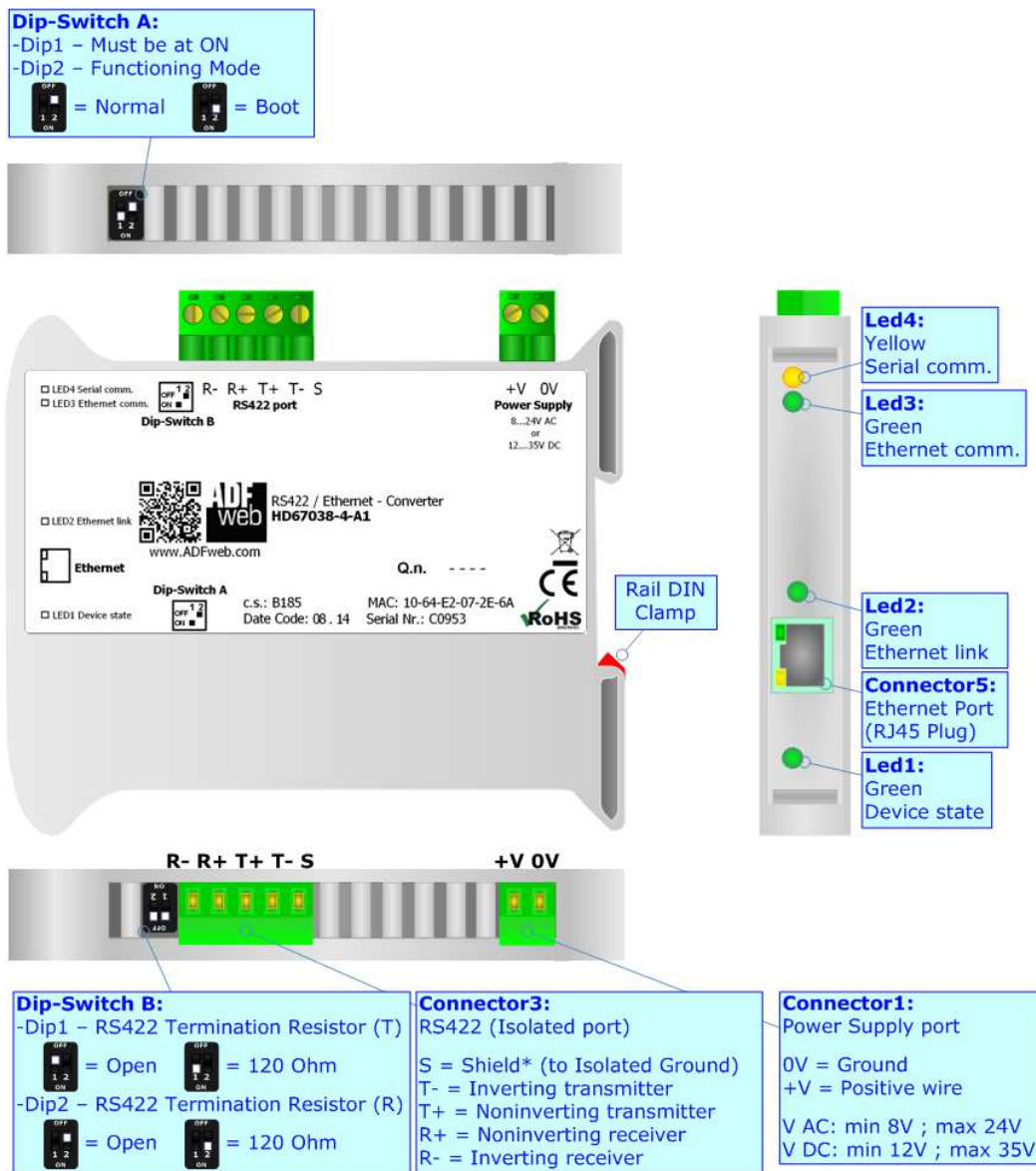

Figure 1c: Connection scheme for HD67038-4-A1

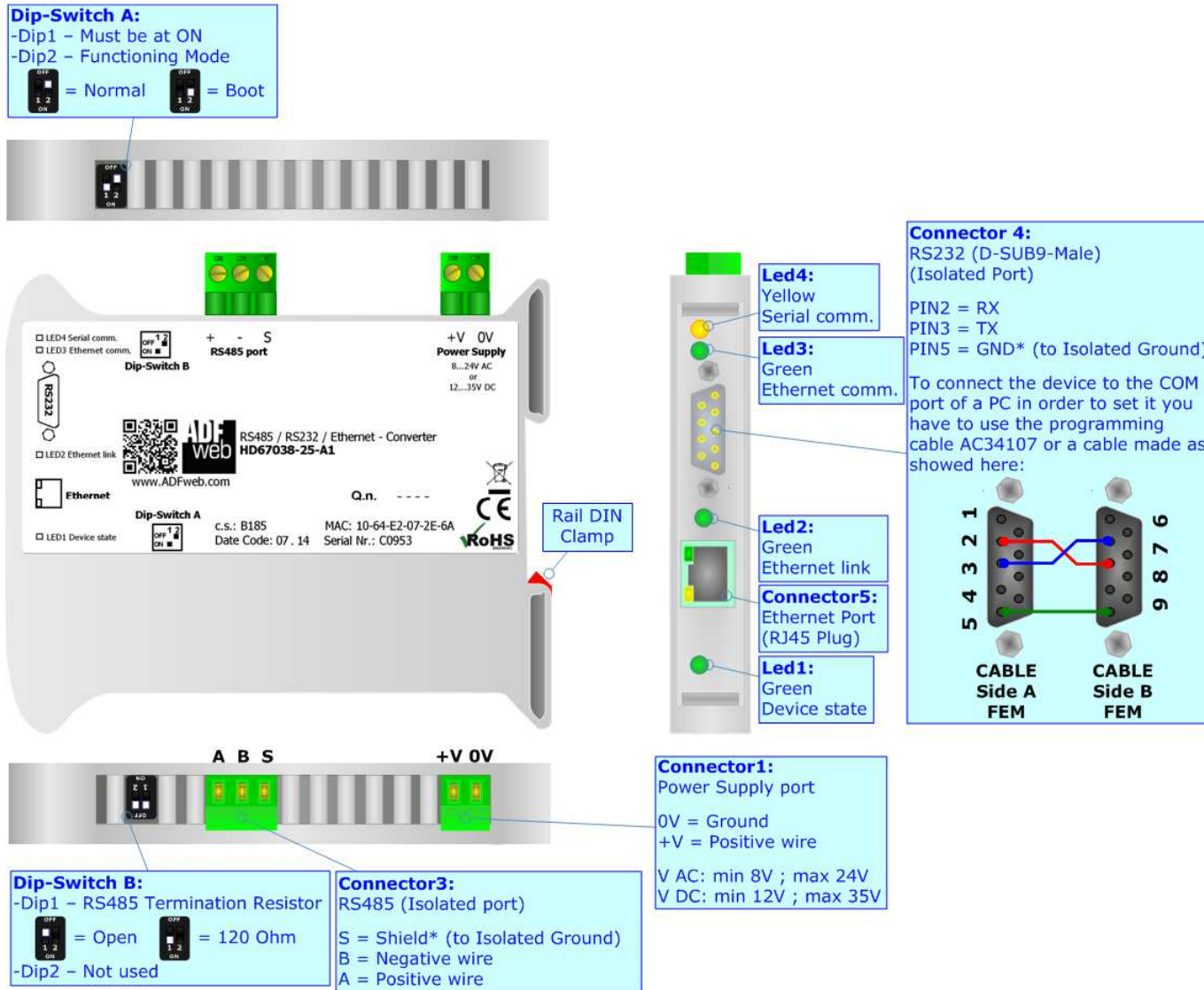

Figure 1d: Connection scheme for HD67038-25-A1

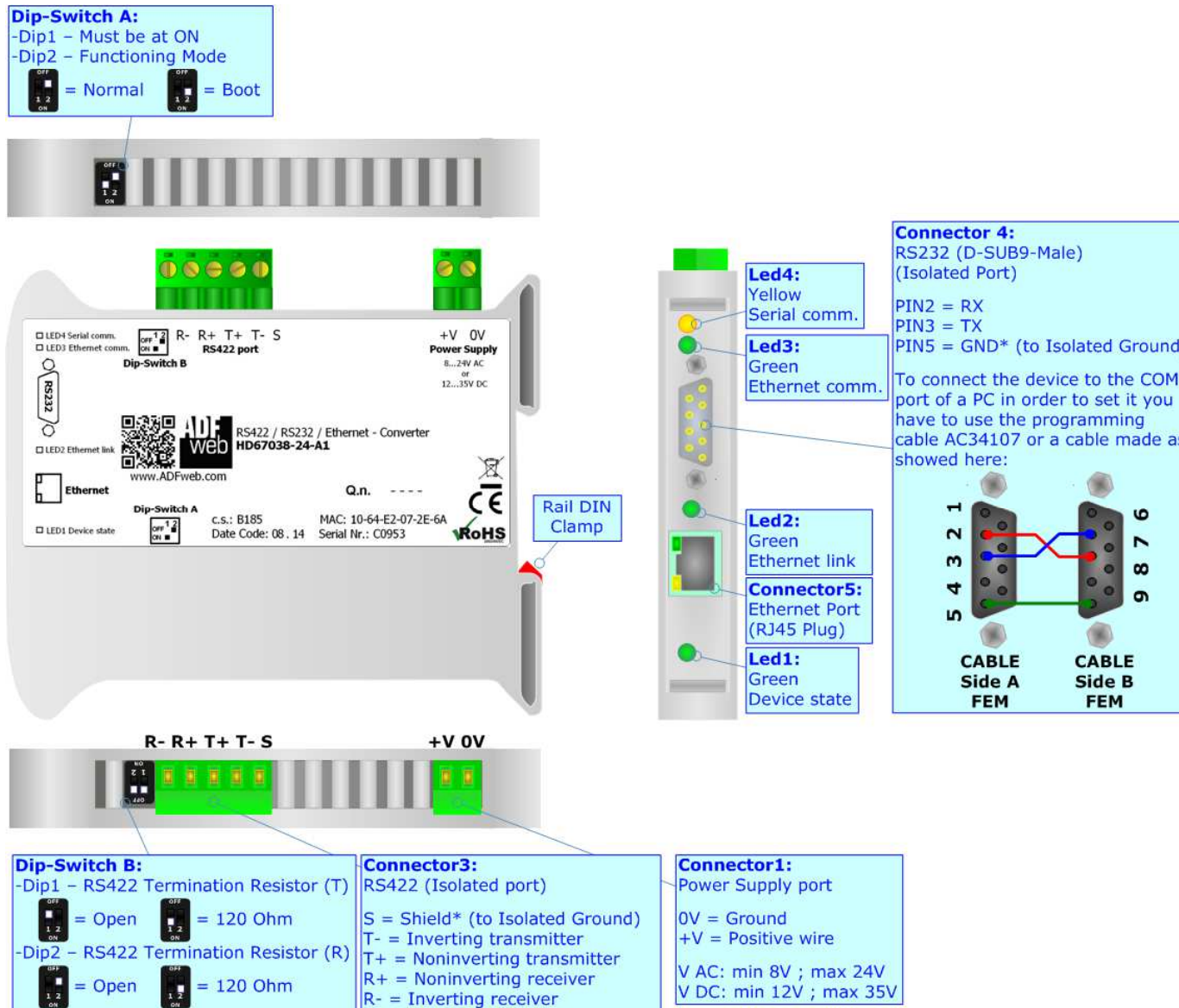

Figure 1e: Connection scheme for HD67038-24-A1

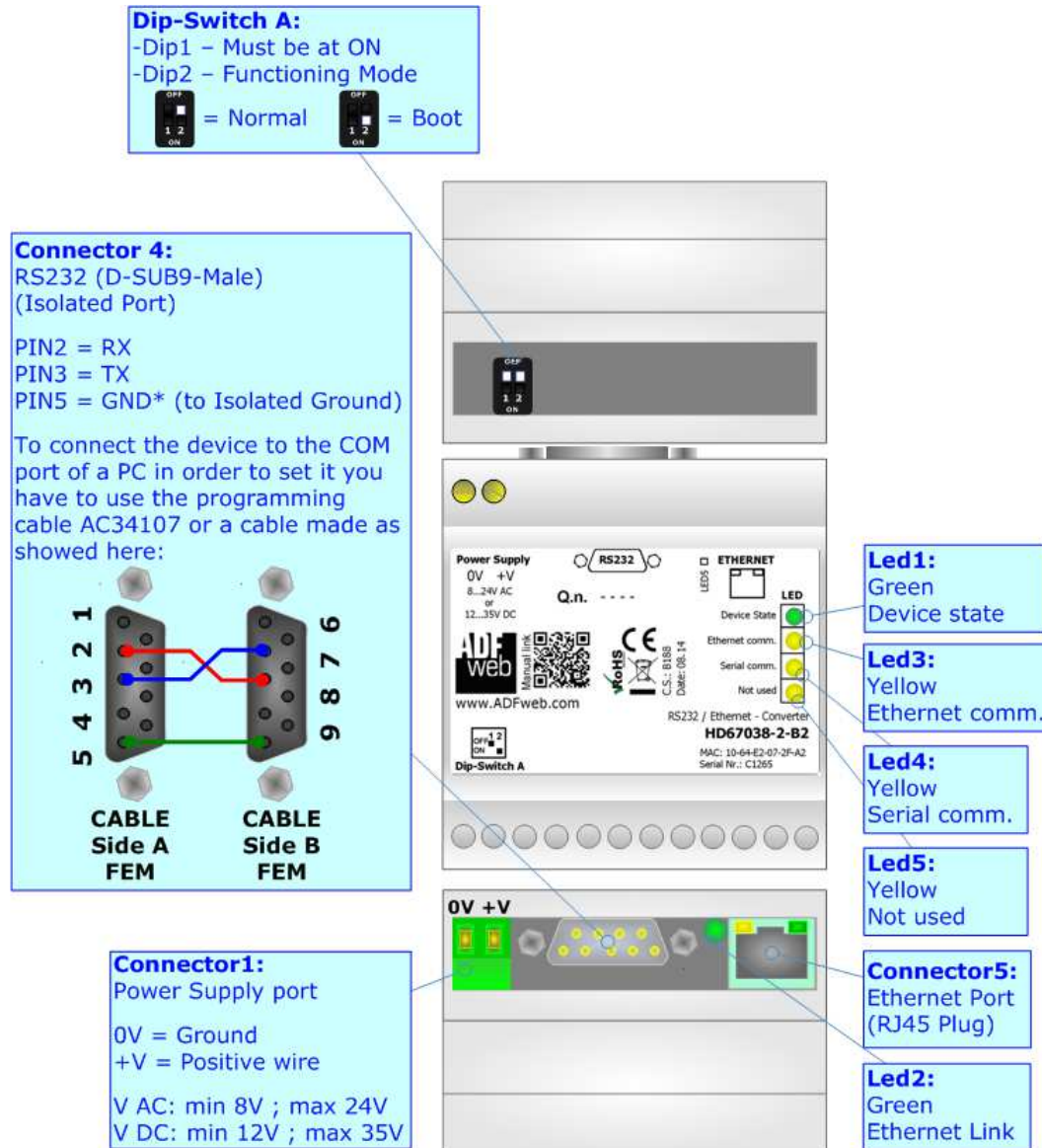

Figure 1f: Connection scheme for HD67038-2-B2

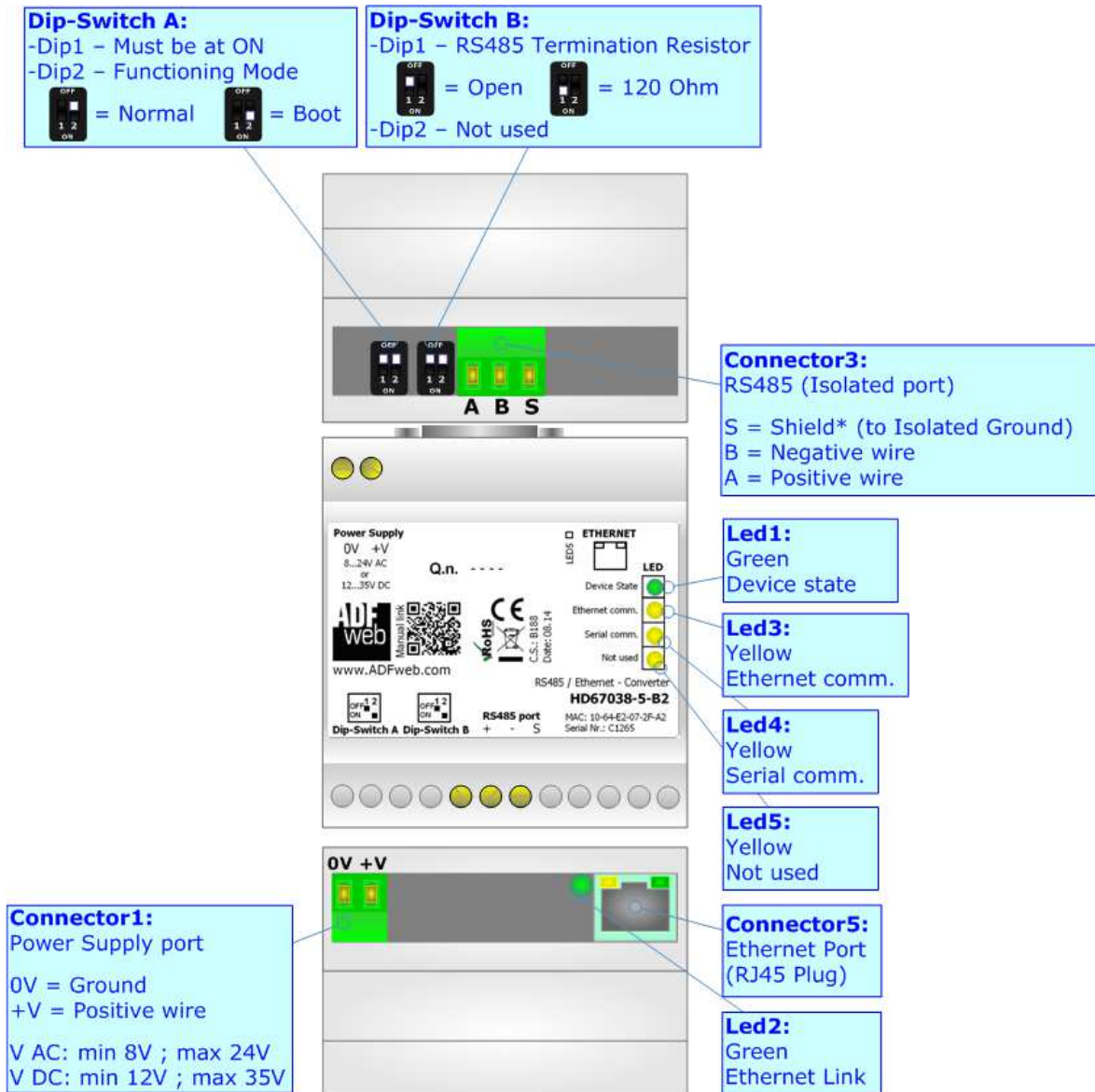

Figure 1g: Connection scheme for HD67038-5-B2

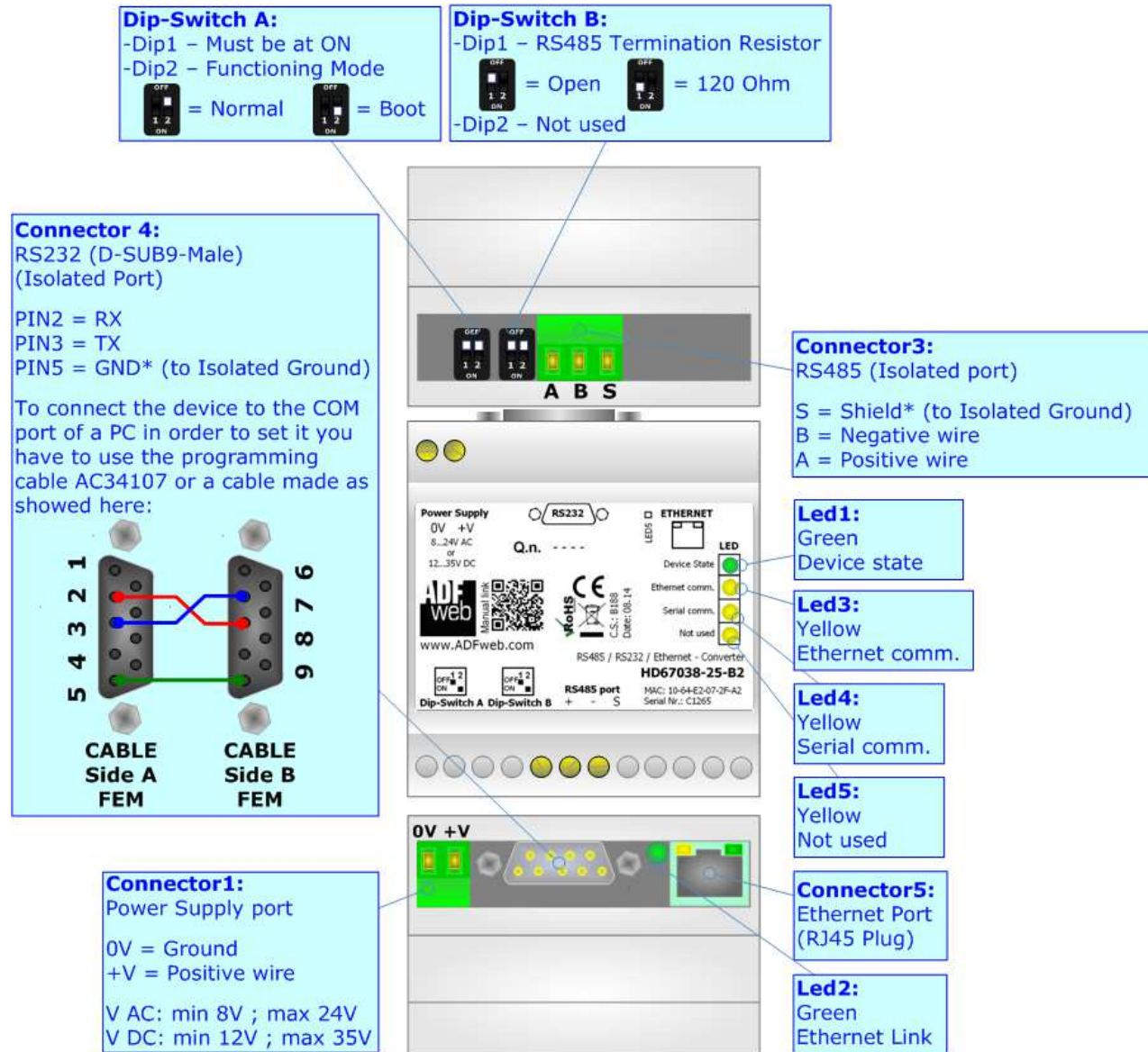

Figure 1h: Connection scheme for HD67038-25-B2

CHARACTERISTICS:

The devices are Ethernet / Serial converter.

They allow the following characteristics:

- Triple isolation between RS232/RS485/RS422 - Power Supply, RS232/RS485/R422- Ethernet, Power Supply - Ethernet.
- Two-directional information between RS232/RS485/RS422 bus and Ethernet bus;
- Mountable on 35mm Rail DIN;
- Auto-sensing Ethernet 10/100;
- Wide power supply input range: 8...24V AC or 12...35V DC;
- Wide temperature range: -40°C / 85°C [-40°F / +185°F].

CONFIGURATION:

You need Compositor SW67038 software on your PC in order to perform the following:

- Define the parameter of Ethernet line;
- Define the parameter of Serial line;
- Update the device.

These devices can be used for doing the following configurations of connection:

- Remote COM Port;
- Tunnel Point to Point (Ethernet bridge for a serial line);
- Tunnel Point to Multipoint.

POWER SUPPLY:

The devices can be powered at 8...24V AC and 12...35V DC. For more details see the two tables below.

VAC		VDC	
Vmin	Vmax	Vmin	Vmax
8V	24V	12V	35V

Consumption at 24V DC:

Device	Consumption [W/VA]
HD67038-2-A1 -B2	3.5
HD67038-5-A1 -B2	3.5
HD67038-4-A1	3.5
HD67038-25-A1 -B2	3.5
HD67038-24-A1	3.5

Connector1:
Power Supply port
0V = Ground
+V = Positive wire
V AC: min 8V ; max 24V
V DC: min 12V ; max 35V

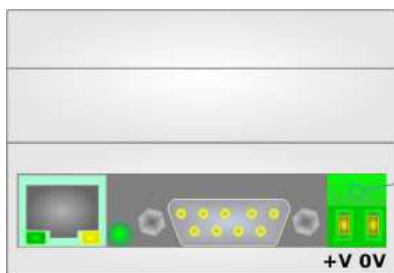
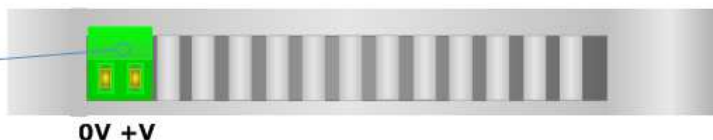

Connector1:
Power Supply port
0V = Ground
+V = Positive wire
V AC: min 8V ; max 24V
V DC: min 12V ; max 35V

Caution: Not reverse the polarity power

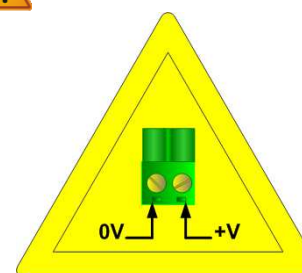

HD67038-2-A1
HD67038-5-A1
HD67038-4-A1
HD67038-25-A1
HD67038-24-A1

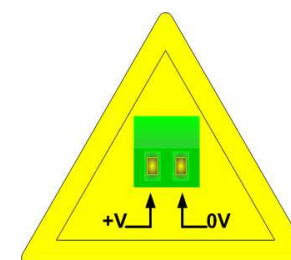

HD67038-2-B2
HD67038-5-B2
HD67038-25-B2

FUNCTION MODES:

The device has got two functions mode depending of the position of the 'Dip2 of Dip-Switch A':

- The first, with 'Dip2 of Dip-Switch A' at "OFF" position, is used for the normal working of the device.
- The second, with 'Dip2 of Dip-Switch A' at "ON" position, is used for upload the Project and/or Firmware.

For the operations to follow for the updating, see 'UPDATE DEVICE' section.

According to the functioning mode, the LEDs will have specifics functions, see 'LEDS' section.

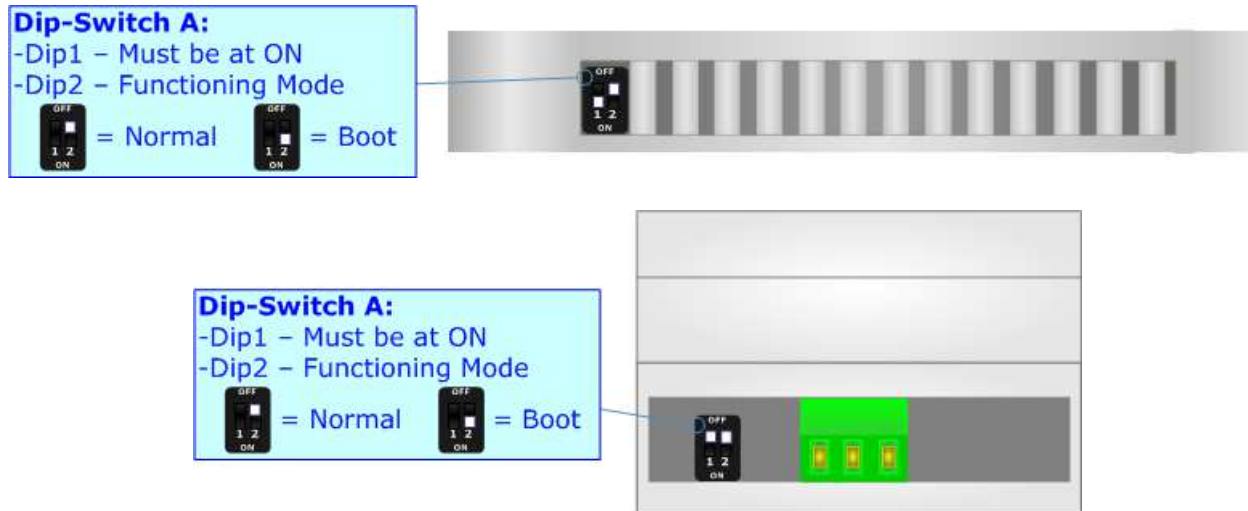

Warning:

Dip1 of 'Dip-Switch A' must be at ON position for working even if the Ethernet cable isn't inserted.

LEDS:

The device has got four (five for -B2 series) LEDs that are used to give information of the functioning status. The various meanings of the LEDs are described in the table below.

LED	Normal Mode	Boot Mode
1: Device state	Blinks slowly (~1Hz)	Blinks quickly: Boot state Blinks very slowly (~0.5Hz): update in progress
2: Ethernet link	ON: Ethernet cable connected OFF: Ethernet cable disconnected	ON: Ethernet cable connected OFF: Ethernet cable disconnected
3: Ethernet comm.	Blinks when are received Ethernet data	Blinks quickly: Boot state Blinks very slowly (~0.5Hz): update in progress
4: Serial comm.	Blinks when receive a Serial data	Blinks quickly: Boot state Blinks very slowly (~0.5Hz): update in progress
5: Not used (present only on -B2 series)	OFF	Blinks quickly: Boot state Blinks very slowly (~0.5Hz): update in progress



ETHERNET:

The Ethernet connection must be made using Connector5 of with at least a Category 5E cable. The maximum length of the cable should not exceed 100m. The cable has to conform to the T568 norms relative to connections in cat.5 up to 100 Mbps. To connect the device to an Hub/Switch is recommended the use of a straight cable, to connect the device to a PC/PLC/other is recommended the use of a cross cable.

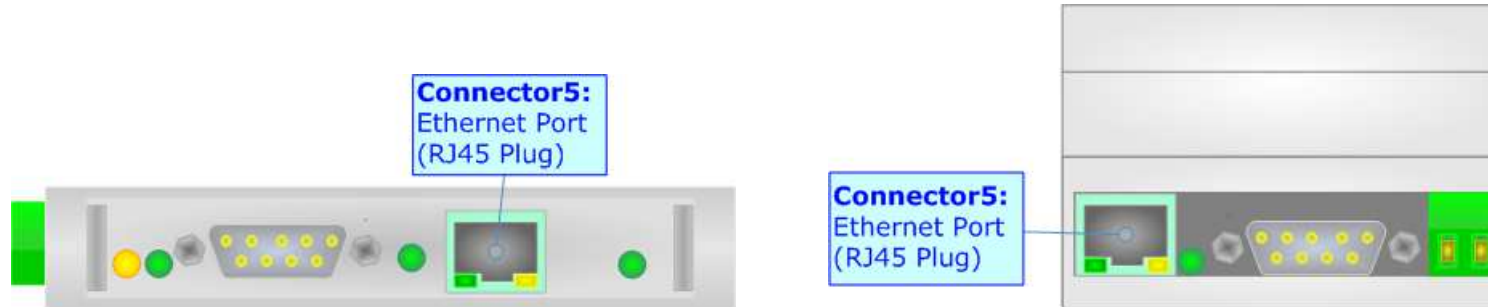

RS422:

For terminate the RS485 line with a 120Ω resistor it is necessary to put ON dip 1 for T line and/or put ON dip 2 for R line, like in figure.

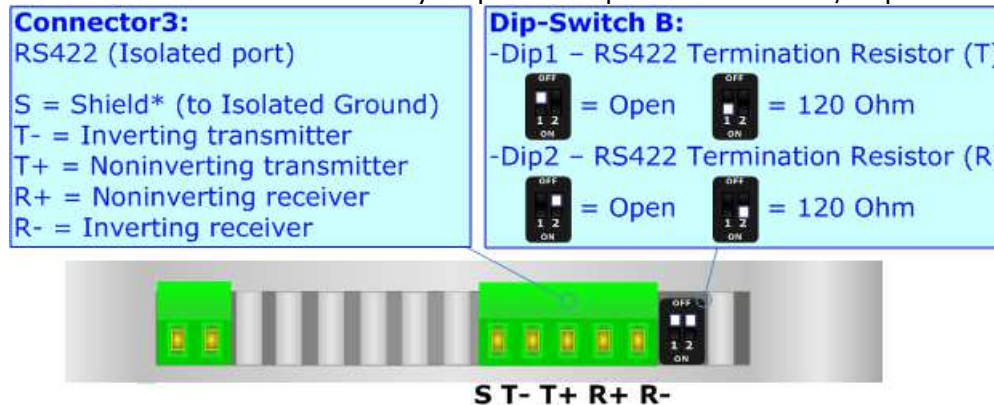

The maximum length of the cable should be 1200m (4000 feet).

RS485:

For terminate the RS485 line with a 120Ω resistor it is necessary to put ON dip 1, like in figure.

Connector3:
RS485 (Isolated port)
S = Shield* (to Isolated Ground)
B = Negative wire
A = Positive wire

Dip-Switch B:
-Dip1 – RS485 Termination Resistor
 = Open = 120 Ohm
-Dip2 – Not used

Connector3:
RS485 (Isolated port)
S = Shield* (to Isolated Ground)
B = Negative wire
A = Positive wire

Dip-Switch B:
-Dip1 – RS485 Termination Resistor
 = 120 Ohm = Open
-Dip2 – Not used

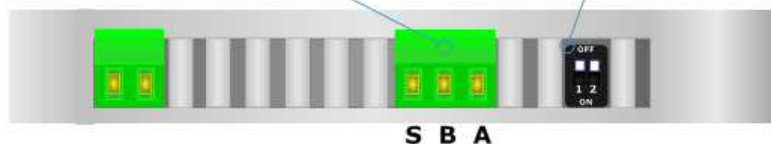

The maximum length of the cable should be 1200m (4000 feet).

Here some codes of cables:

- Belden: p/n 8132 - 2x 28AWG stranded twisted pairs conductor + foil shield + braid shield;
- Belden p/n 82842 - 2x 24AWG stranded twisted pairs conductor + foil shield + braid shield;
- Tasker: p/n C521 - 1x 24AWG twisted pair conductor + foil shield + braid shield;
- Tasker: p/n C522 - 2x 24AWG twisted pairs conductor + foil shield + braid shield.

RS232:

The connection from RS232 socket to a serial port (example one from a personal computer) must be made with a Null Modem cable (a serial cable where the pins 2 and 3 are crossed).

It is recommended that the RS232 cable not exceed 15 meters.

The device is provided with a D-sub connector type DE-9 Male (also called DB-9). The cable must use a DE-9 Female connector.

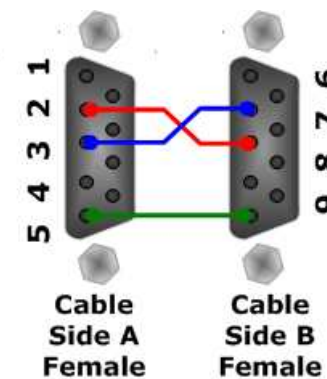

USE OF COMPOSITOR SW67038:

To configure the Converter, use the available software that runs with Windows called SW67038. It is downloadable on the site www.adfweb.com and its operation is described in this document. *(This manual is referenced to the last version of the software present on our web site).* The software works with MSWindows (XP, Vista, Seven, 8, 10; 32/64bit).

When launching the SW67038, the window below appears (Fig. 2).

 **Note:**
It is necessary to have installed .Net Framework 4.

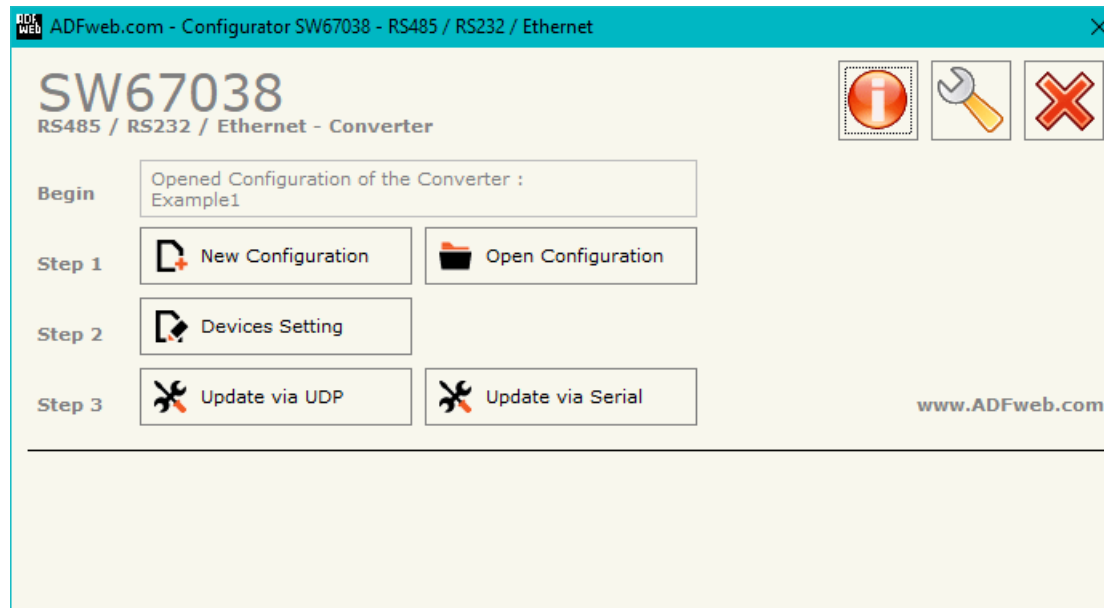
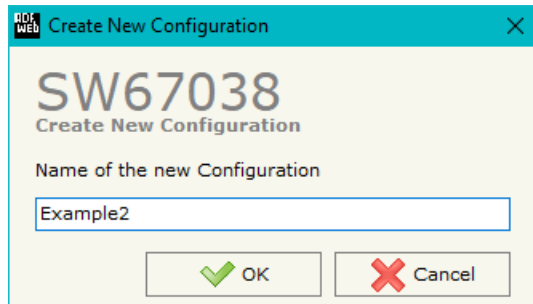

Figure 2: Main window for SW67038

NEW CONFIGURATION / OPEN CONFIGURATION:

The **"New Configuration"** button creates the folder which contains the entire device's configuration.



A device's configuration can also be imported or exported:

- To clone the configurations of a Programmable "RS485 / RS232 / Ethernet - Converter" in order to configure another device in the same manner, it is necessary to maintain the folder and all its contents;
- To clone a project in order to obtain a different version of the project, it is sufficient to duplicate the project folder with another name and open the new folder with the button **"Open Configuration"**.

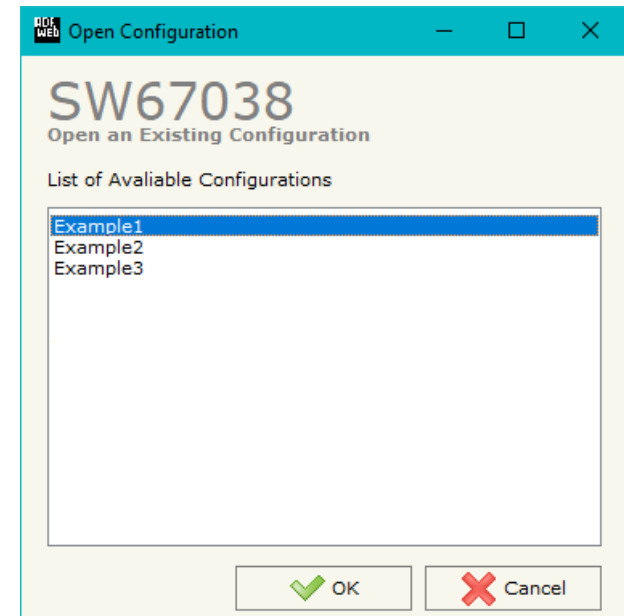

SOFTWARE OPTIONS:

By pressing the “**Settings**” () button there is the possibility to change the language of the software and check the updatings for the compositor.

In the section “Language” it is possible to change the language of the software.

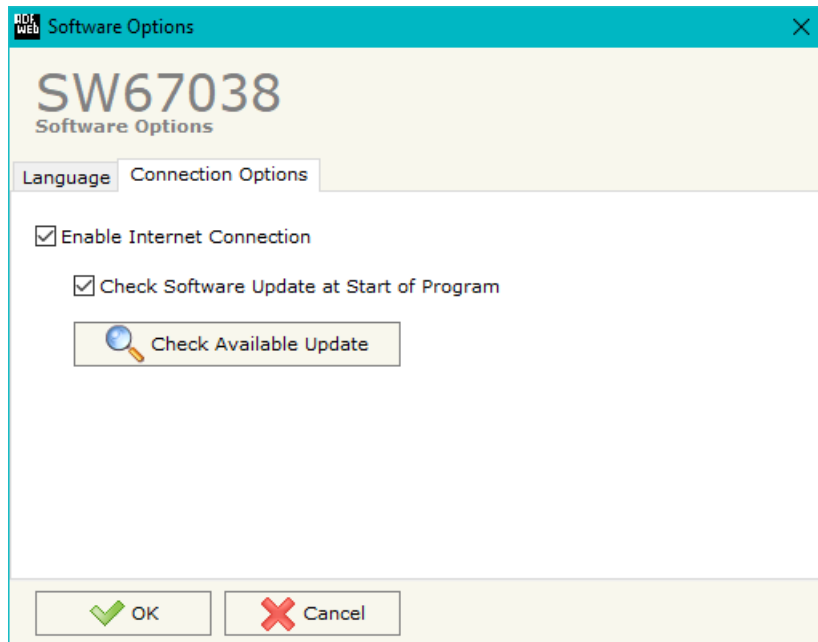

In the section “Connection Options”, it is possible to check if there are some updatings of the software compositor in ADFweb.com website. Checking the option “**Check Software Update at Start of Program**”, the SW67038 check automatically if there are updatings when it is launched.

DEVICES SETTING:

By Pressing the "**Devices Setting**" button from the main window for SW67038 (Fig. 2), the window "Devices Setting" appears (Fig. 3 or 4 or 5 or 6).

In the section "**Select Modality**" field it is possible to select the function mode of the Converter from these options:

- **Remote COM Port;**
- **Tunnel Point to Point;**
- **Tunnel Point to MultiPoint.**

These operating modalities are described in the following pages.

In the section "**Select Device**" field it is possible to select the device used for the project. These devices are available:

- HD67038-2-A1 (/B2) New hardware version
- HD67038-5-A1 (/B2) New hardware version
- HD67038-4-A1 New hardware version
- HD67038-25-A1 (/B2) New hardware version
- HD67038-24-A1 New hardware version
- HD67038-2 Old hardware version
- HD67038-25 Old hardware version
- HD67038M-2 Old hardware version
- HD67038M-25 Old hardware version

OPERATING MODALITY: REMOTE COM PORT

It consists of a configuration in which the device is generally controlled by a PC that is connected using the TCP or UDP protocol. It writes bytes that automatically are sent on the serial line and each byte read from the serial port is transmitted through the line to the connected PC.

The means of the fields for "ETHERNET" are:

- In the field "**IP Address**" the IP address of the converter is defined;
- In the field "**SubNet Mask**" the Subnet Mask of the converter is defined;
- If the field "**Use Gateway**" is checked, in the field below it is possible to insert the IP Address of the gateway used for going out to the net.

The means of the fields for "RS232/RS485/RS422" are:

- The field "**Enable Serial**" is used for selecting if the serial is used (field checked) or not (field unchecked). For the codes with only one serial, this field isn't editable (it is always checked); for the codes with two serials, at least one of the two must be checked.
- In the field "**Port**" the port used to communicate with converter using TCP/UDP protocol is defined. The port of second serial must be different from the first one;
- In the field "**Socket Disconnect TimeOut (Seconds)**" a time in seconds is defined. If no data pass through the socket for the seconds defined, the socket disconnects.
- In the field "**Baudrate**" the data rate of the serial line in use is defined;
- In the field "**Parity**" the parity of the serial line in use is defined;
- In the field "**Data Bits**" the number of data bits used for the serial line communication is defined;
- In the field "**Stop Bit**" the number of Stop bits used for the serial line communication is defined;
- In the field "**Data Packing**" the serial to Ethernet conversion's method is defined:
 - Default: standard way defined in the firmware;
 - Length: defined number of bytes in the field on the right;
 - Timeout: after a defined time with no communication in the field on the right;
 - Delimiter: after a specific char defined in the field on the right.

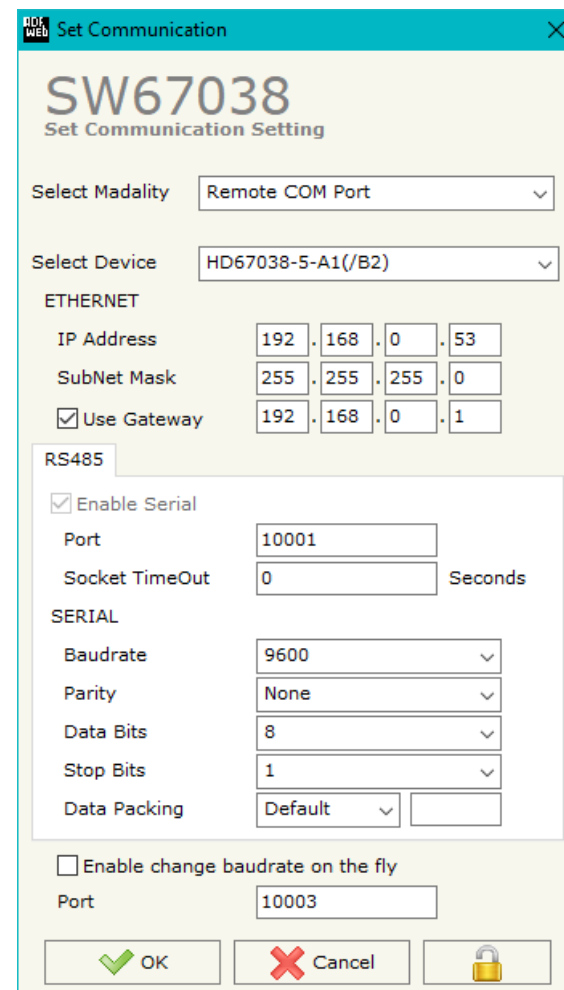

Figure 3: "Devices Setting" window (Remote COM Port)

- If the "**Enable Change baudrate on the fly**" is checked, it is possible to change the baudrate, parity and data bits of the serial from an Ethernet command (see "CHANGE BAUDRATE ON THE FLY" section);
- In the field "**Port**" the port where addressing the command for the Baudrate change is defined.

The "**Active Serial Driver**" button is used to activate the "Serial to Ethernet Connector". For more details go to page 37.

OPERATING MODALITY: TUNNEL POINT TO POINT

A mode that allows the extension of a serial line using a Ethernet network. The two devices in this mode must be configured in a coherent way in order to allow the Ethernet communication between them.

The window is divided in two section, one for Device1 and the other for Device2. It is possible to assign a label to each device in order to have a name to use for understand the project to upload.

The means of the fields for "ETHERNET" are:

- In the field "**IP Address**" the IP address of the converter is defined;
- In the field "**SubNet Mask**" the Subnet Mask of the converter is defined;
- If the field "**Use Gateway**" is checked, in the field below it is possible to insert the IP Address of the gateway used for going out to the net.

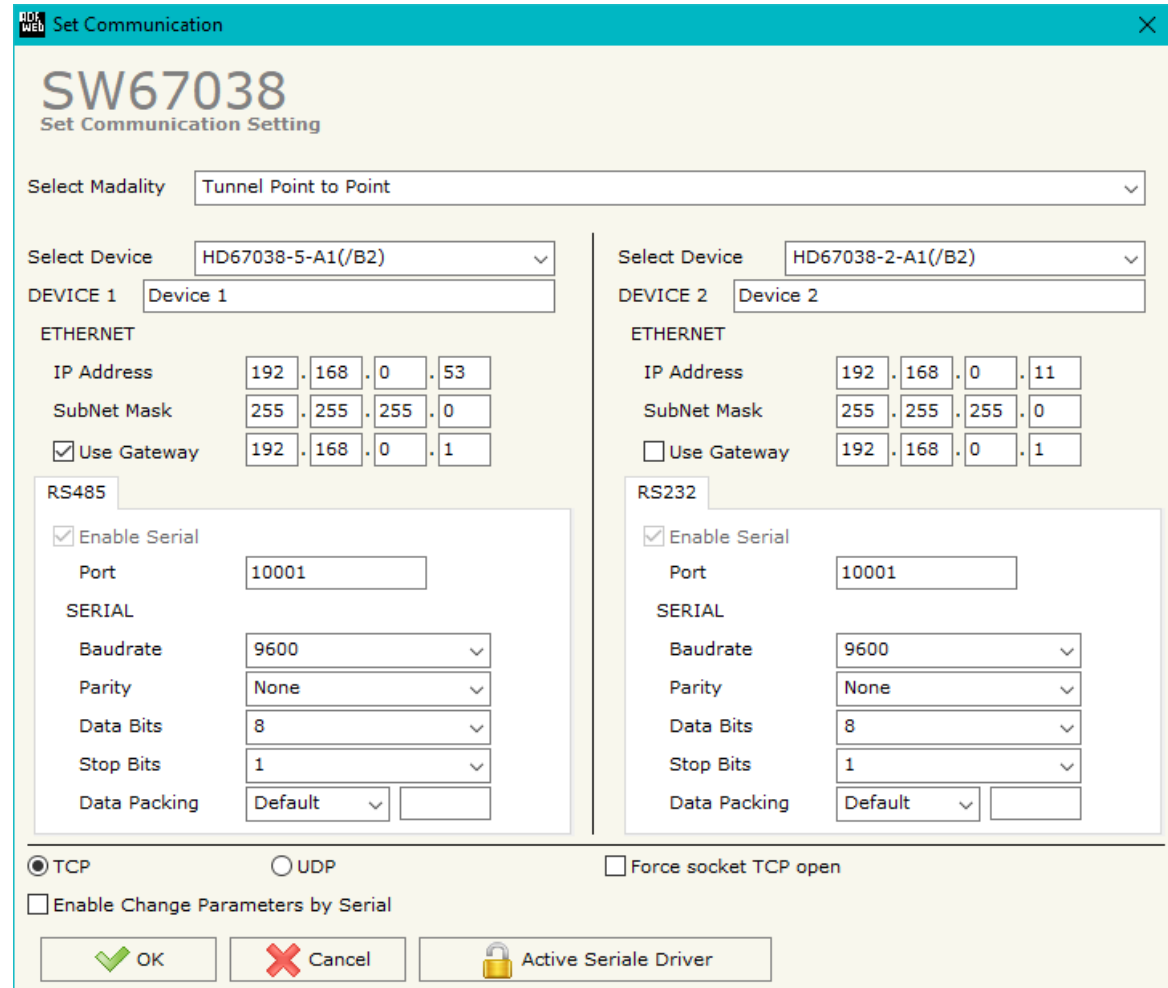

Figure 4: "Devices Setting" window (Tunnel Point to Point)

The means of the fields for "RS232/RS485/RS422" are:

- The field "**Enable Serial**" is used for selecting if the serial is used (field checked) or not (field unchecked). For the codes with only one serial, this field isn't editable (it is always checked); for the codes with two serials, at least one of the two must be checked.
- In the field "**Port**" the port used to communicate with converter using TCP/UDP protocol is defined. The port of second serial must be different from the first one;
- In the field "**Socket Disconnect TimeOut (Seconds)**" a time in seconds is defined. If no data pass through the socket for the seconds defined, the socket disconnects.
- In the field "**Baudrate**" the data rate of the serial line in use is defined;
- In the field "**Parity**" the parity of the serial line in use is defined;
- In the field "**Data Bits**" the number of data bits used for the serial line communication is defined;
- In the field "**Stop Bit**" the number of Stop bits used for the serial line communication is defined;
- In the field "**Data Packing**" the serial to Ethernet conversion's method is defined:
 - Default: standard way defined in the firmware;
 - Length: defined number of bytes in the field on the right;
 - Timeout: after a defined time with no communication in the field on the right;
 - Delimiter: after a specific char defined in the field on the right.
- If the field "**TCP**" is checked, the Protocol used is the TCP, if the field "**UDP**" is checked, the Protocol used is the UDP. Only if the protocol is "TCP", it is possible to select the field "**Force socket TCP open**". When it is selected, the converter opens the TCP connection with the end-point automatically at start-up and, if the end-point closes the connection, the converter tries to reopen it cyclically.

OPERATING MODALITY: TUNNEL POINT TO MULTIPPOINT WITH BROADCAST

This mode allows to extend a serial line based on Master-Slave concept, where there are more Slave lines dislocated in different places.

Note: This modality uses UDP packets.

The window is divided in two section, one for Master device and the other for Slave devices. It is possible to assign a label to each device in order to have a name to use for understand the project to upload.

The means of the fields for "ETHERNET" are:

- In the field "**IP Address**" the IP address of the converter is defined;
- In the field "**SubNet Mask**" the Subnet Mask of the converter is defined;

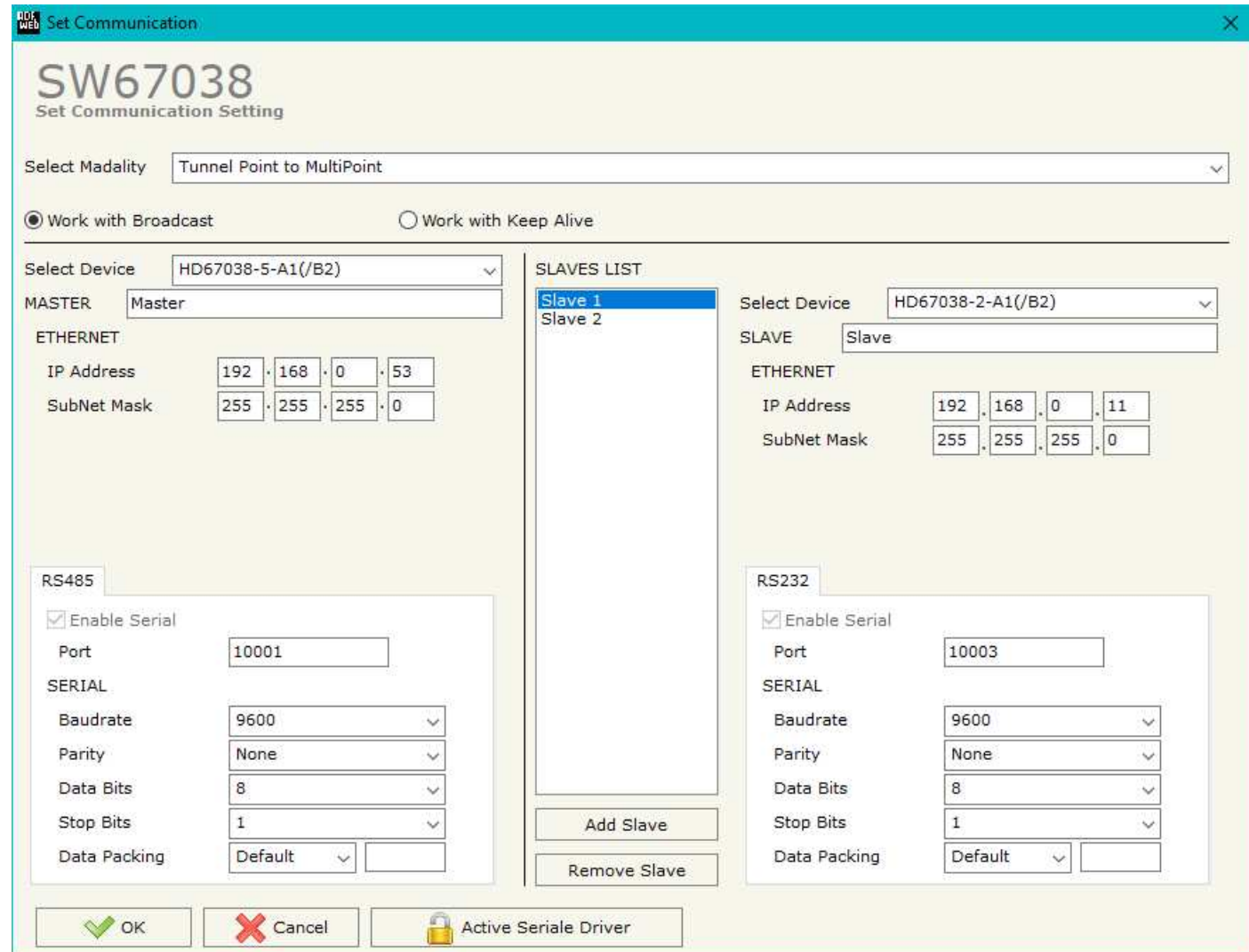

Figure 5: "Devices Setting" window (Tunnel Point to MultiPoint, Work with Broadcast)

The means of the fields for "RS232/RS485/RS422" are:

- The field "**Enable Serial**" is used for selecting if the serial is used (field checked) or not (field unchecked). For the codes with only one serial, this field isn't editable (it is always checked); for the codes with two serials, at least one of the two must be checked.
- In the field "**Port**" the port used to communicate with converter using UDP protocol is defined. The port of second serial must be different from the first one;
- In the field "**Socket Disconnect TimeOut (Seconds)**" a time in seconds is defined. If no data pass through the socket for the seconds defined, the socket disconnects.
- In the field "**Baudrate**" the data rate of the serial line in use is defined;
- In the field "**Parity**" the parity of the serial line in use is defined;
- In the field "**Data Bits**" the number of data bits used for the serial line communication is defined;
- In the field "**Stop Bit**" the number of Stop bits used for the serial line communication is defined;
- In the field "**Data Packing**" the serial to Ethernet conversion's method is defined:
 - Default: standard way defined in the firmware;
 - Length: defined number of bytes in the field on the right;
 - Timeout: after a defined time with no communication in the field on the right;
 - Delimiter: after a specific char defined in the field on the right.

For adding a new slave in the section "SLAVES LIST", it is necessary to press the "**Add Slave**" button. After that it is possible to select the new slave from the list and modify the values.

For deleting a slave present in the "SLAVES LIST", it is necessary to select the desired slave and press the "**Remove Slave**" button.



Note:

In the case of the MASTER, the packets are sent in broadcast.

OPERATING MODALITY: TUNNEL POINT TO MULTIPPOINT WITH KEEP ALIVE

This mode allows to extend a serial line based on Master-Slave concept, where there are more Slave lines dislocated in different places.

Note: This modality uses UDP packets.

The window is divided in two section, one for Master device and the other for Slave devices. It is possible to assign a label to each device in order to have a name to use for understand the project to upload.

The means of the fields for "ETHERNET" are:

- In the field "**IP Address**" the IP address of the converter is defined;
- In the field "**SubNet Mask**" the Subnet Mask of the converter is defined;
- If the field "**Use Gateway**" is checked, in the field below it is possible to insert the IP Address of the gateway used for going out to the net in the field under;

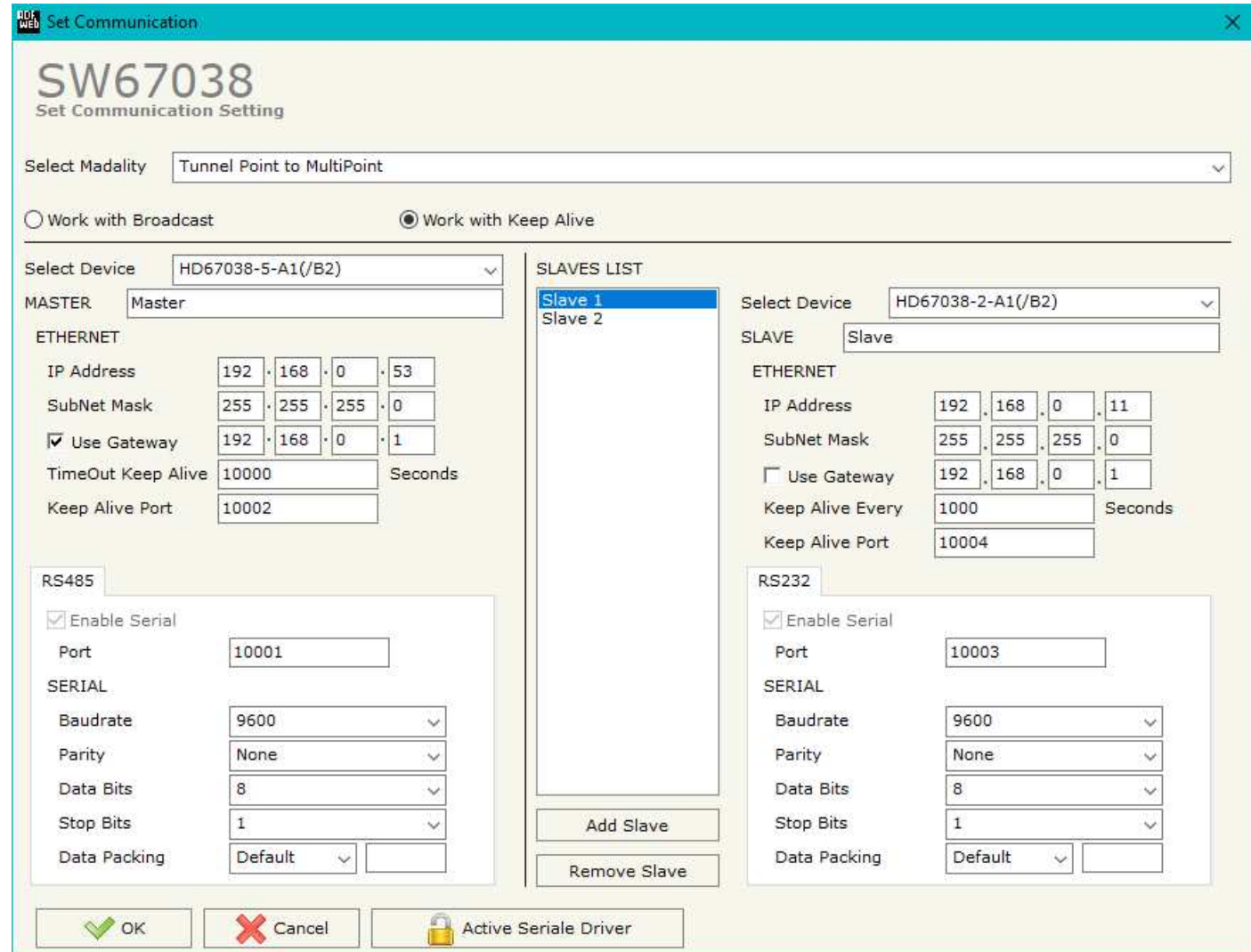

Figure 6: "Devices Setting" window (Tunnel Point to MultiPoint, Work with Keep Alive)

- In the field "**TimeOut Keep Alive (Seconds)**" the time that the Master waits for receiving a Keep Alive from a Slave is defined. If at least one Keep Alive message isn't arrived from a slave in this time, the Master doesn't send the serial data to that Slave.
- In the field "**Keep Alive Every (Seconds)**" the time interval between the Keep Alive messages sent by the Slaves is defined;
- In the field "**Keep Alive Port**" the port used by the Master for receiving the Keep Alive messages from the Slaves, or used by the Slaves for sending the the Keep Alive message to the Master, is defined.

The means of the fields for "RS232/RS485/RS422" are:

- The field "**Enable Serial**" is used for selecting if the serial is used (field checked) or not (field unchecked). For the codes with only one serial, this field isn't editable (it is always checked); for the codes with two serials, at least one of the two must be checked.
- In the field "**Port**" the port used to communicate with converter using UDP protocol is defined. The port of second serial must be different from the first one;
- In the field "**Socket Disconnect TimeOut (Seconds)**" a time in seconds is defined. If no data pass through the socket for the seconds defined, the socket disconnects.
- In the field "**Baudrate**" the data rate of the serial line in use is defined;
- In the field "**Parity**" the parity of the serial line in use is defined;
- In the field "**Data Bits**" the number of data bits used for the serial line communication is defined;
- In the field "**Stop Bit**" the number of Stop bits used for the serial line communication is defined;
- In the field "**Data Packing**" the serial to Ethernet conversion's method is defined:
 - Default: standard way defined in the firmware;
 - Length: defined number of bytes in the field on the right;
 - Timeout: after a defined time with no communication in the field on the right;
 - Delimiter: after a specific char defined in the field on the right.

For adding a new slave in the section "SLAVES LIST", it is necessary to press the "**Add Slave**" button. After that it is possible to select the new slave from the list and modify the values.

For deleting a slave present in the "SLAVES LIST", it is necessary to select the desired slave and press the "**Remove Slave**" button.



Note:

In the case of the MASTER, the UDP packets are sent to each slave that is present and active in the network.

UPDATE VIA SERIAL:

By pressing the **Update Via Serial** button it is possible to load the created configuration into the device, and also the Firmware if is necessary. This by using the RS232 port.



Note:

With this type of update is possible to update only the hardware with jumpers (old version no longer sold).

In order to load the parameters or update the firmware in the device, follow these instructions:

- Turn OFF the Device;
- Connect the RS232 Null Modem cable form your PC to the Converter;
- Put Dip2 of 'Dip-Switch A' in ON position;
- Select the **COM port** and press the **Connect** button;
- Turn ON the device;
- Check the "Device state" Led. It must blink quickly (see "LEDS" section);
- Press the **Next** button;
- Select which operations you want to do.
- Press the **Execute Update Firmware** button to start the upload;
- When all the operations are "OK" turn OFF the device;
- Put Dip2 of 'Dip-Switch A' in OFF position;
- Turn ON the device.

At this point the configuration/firmware on the device is correctly updated.

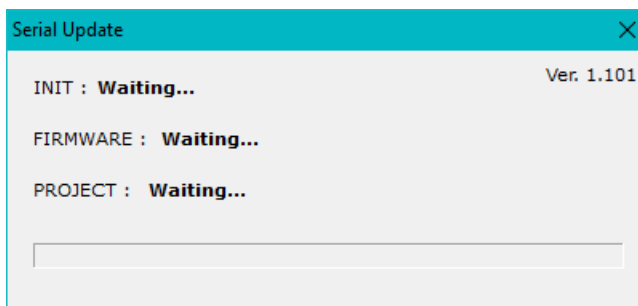
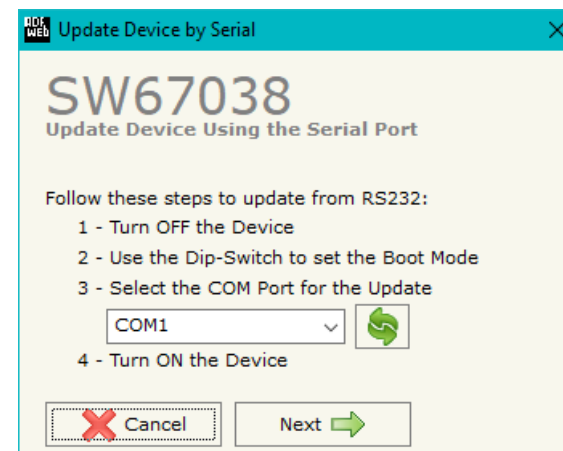

Figure 7: "Update Device via Serial" windows

UPDATE VIA UDP:

By pressing the **“Update via UDP”** button, it is possible to load the created configuration into the device; and also the Firmware, if necessary. This by using the Ethernet port.

If you don't know the actual IP address of the device you have to use this procedure:

- Turn OFF the device;
- Put Dip2 of 'Dip-Switch A' in ON position;
- Turn ON the device;
- Connect the Ethernet cable;
- Insert the IP **“192.168.2.205”**;
- Press the **“Ping”** button, “Device Found!” must appear;
- Press the **“Next”** button;
- Select which operations you want to do;
- Press the **“Execute update firmware”** button to start the upload;
- When all the operations are “OK” turn OFF the Device;
- Put Dip2 of 'Dip-Switch A' in OFF position;
- Turn ON the device.

If you know the actual IP address of the device, you have to use this procedure:

- Turn ON the Device with the Ethernet cable inserted;
- Insert the actual IP of the Converter;
- Press the **“Ping”** button, must appear “Device Found!”;
- Press the **“Next”** button;
- Select which operations you want to do;
- Press the **“Execute update firmware”** button to start the upload;
- When all the operations are “OK” the device automatically goes at Normal Mode.

At this point the configuration/firmware on the device is correctly updated.

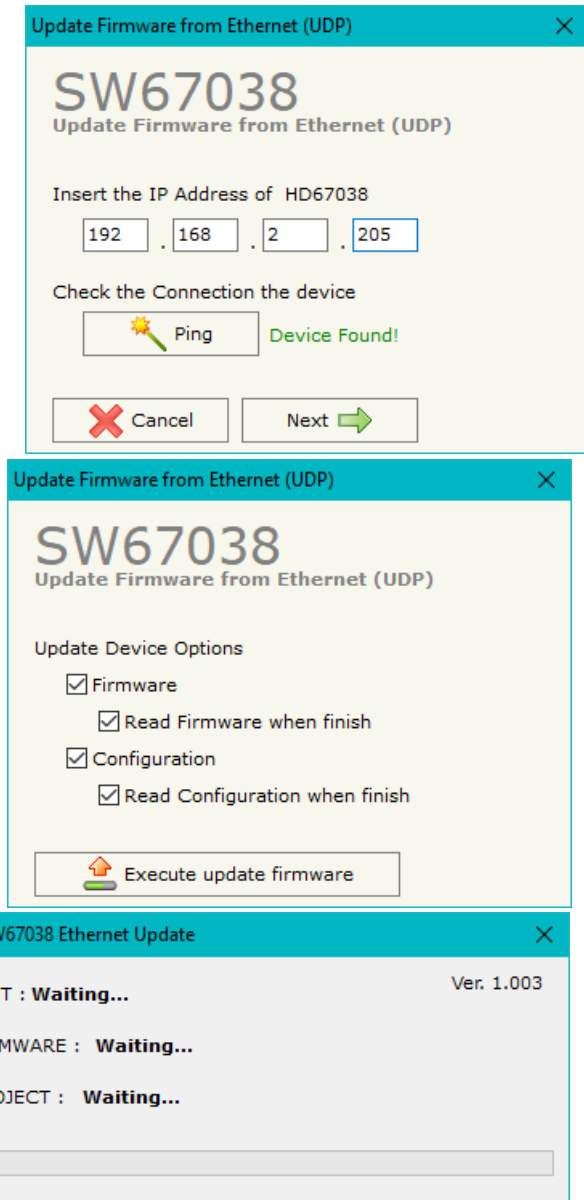

Figure 8: “Update device” windows

**Note:**

When you install a new version of the software, if it is the first time it is better you do the update of the Firmware in the HD67038 device.

**Note:**

When you receive the device, for the first time, you also have to update the Firmware in the HD67038 device.

**Warning:**

If Fig. 9 appears when you try to do the Update try these points before seeking assistance:

- Check if the serial COM port selected is the correct one;
- Check if the serial cable is connected between the PC and the device;
- Try to repeat the operations for the updating;
- If you are using a USB↔RS232 converter try with a native COM port or change the converter;
- Try to repeat the operations for the updating;
- Try with another PC;
- Try to restart the PC;
- Check the LAN settings;
- Check the Wi-Fi settings;
- If you are using the program inside a Virtual Machine, try to use in the main Operating System;
- If you are using Windows Seven, Vista and 8 make sure that you have the administrator privileges;
- In case you have to program more than one device, using the "UDP Update", you have to cancel the ARP table every time you connect a new device on Ethernet. For do this you have to launch the "Command Prompt" and write the command "arp -d". Pay attention that with Windows Vista, Seven, 8 you have to launch the "Command Prompt" with Administrator Rights;
- Pay attention at Firewall lock.

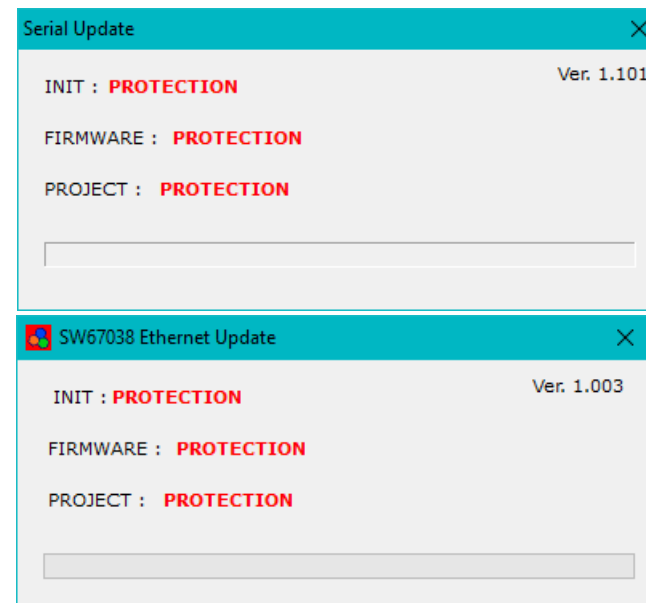

Figure 9: "Protection" window



In the case of HD67038 you have to use the software "SW67038": www.adfweb.com/download/filefold/SW67038.zip.

CHANGE BAUDRATE AND PARITY ON THE FLY:

Enabling the option “**Enable change baudrate on the fly**” in the modality “Remote COM Port” is possible to change the baudrate, parity and data bits of the serial port by sending a UDP frame into the selected “**Port**”. The new baudrate, parity and data bits are saved in RAM so when you turn off the device you lose these parameters and the device starts with the default value.



Note:

You can use this modality only in the “Remote COM port” modality.

The packet to send for change these parameters are:

BAUD=<baud value>;PARITY=<parity value>;DATABIT=<parity value>;<serial type>;

The admitted value for Baudrate are:

1200, 2400, 4800, 9600, 19200, 38400, 57600 and 115200

The Admitted value for Parity are:

- 0 (= None)
- 1 (= Odd)
- 2 (= Even)

The Admitted value for Data Bits are:

- 7 (= 7 Data Bits)
- 8 (= 8 Data Bits)

The admitted value for “serial type” are:

- 232 (= RS232)
- 485 (= RS485)

Example.

To set the Baudrate of RS485 port at 115200, Odd parity and 7 data bits, you have to send in ASCII:

“BAUD=115200;PARITY=0;DATABIT=7;485;”

In hexadecimal:

[42][41][55][44][3D][31][31][35][32][30][30][3B][50][41][52][49][54][59][3D][30][3B][44][41][54][41][42][49][54][3D][37][3B][34][38][35][3B]

ACTIVE SERIAL DRIVER:

Before pressing the “**Active Serial Driver**” button from the “General Parameter” window it is necessary to download the “Serial to Ethernet Connector” software from the following link: www.adfweb.com/download/filefold/serial_ethernet_connector.zip. After the installation of the software you have to enter in the SW67038, go into the “General Parameter” section and press the “ACTIVE SERIAL DRIVER” button. At this point it is possible to configure the virtual COM port following these steps:

Go in the “Type” Section.

- Step 1** - Active the Advanced Mode;
- Step 2** - Active the Client Mode;
- Step 3** - Select the COM port to use with the device. It is better if you use a COM port that does not exist in your system;
- Step 4** - Insert the IP Address and the Port of the Device and then press the “ADD” button;
- Step 5** - Check that the IP and the Port are correct.

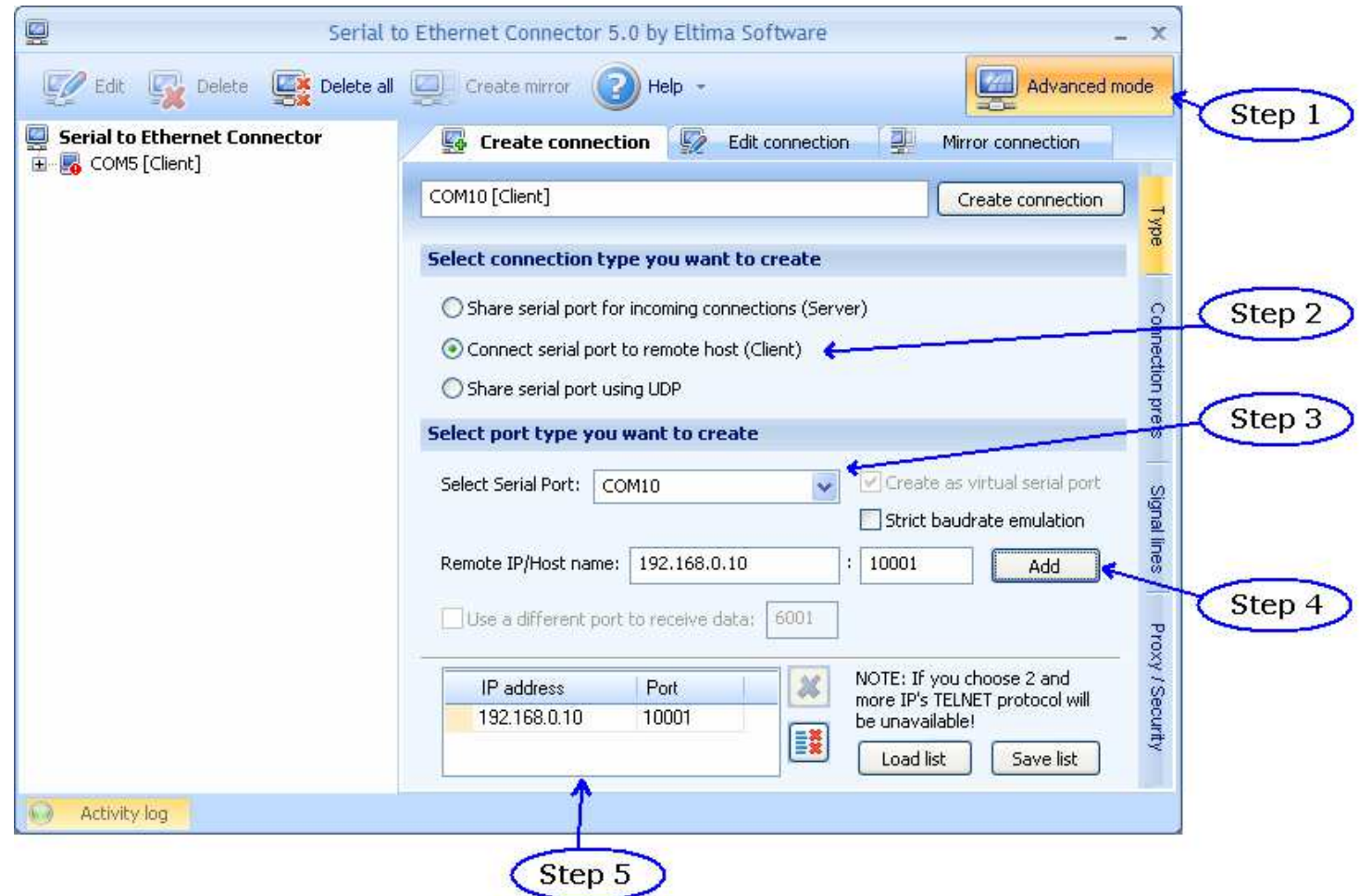

Go in the "Connection prefs" Section.

- Step 1** – Select the RAW protocol;
- Step 2** – Select the "Send Keep alive" option;
- Step 3** – Confirm the parameters and create the Virtual COM port.

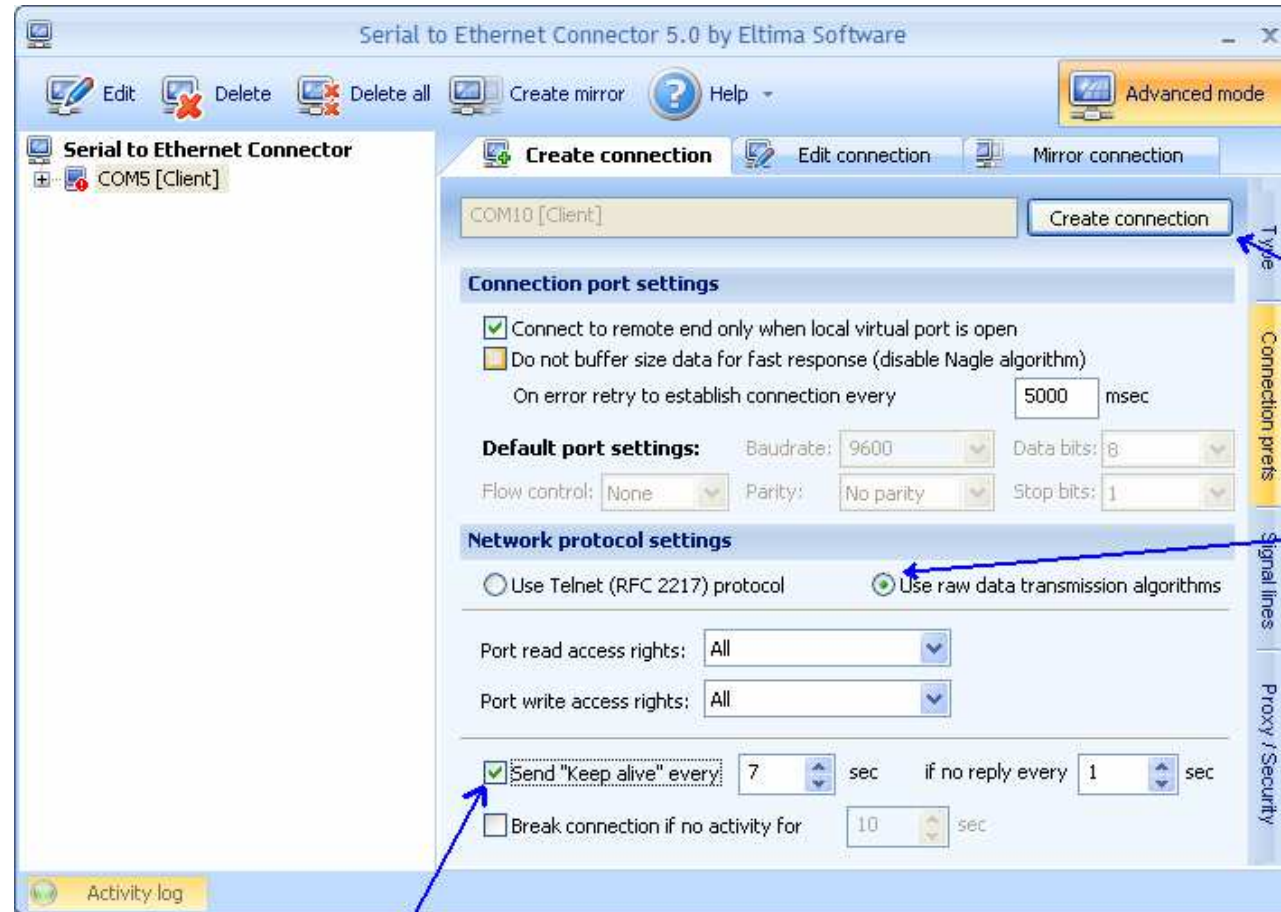

Step 2

Step 3

Step 1

MECHANICAL DIMENSIONS:

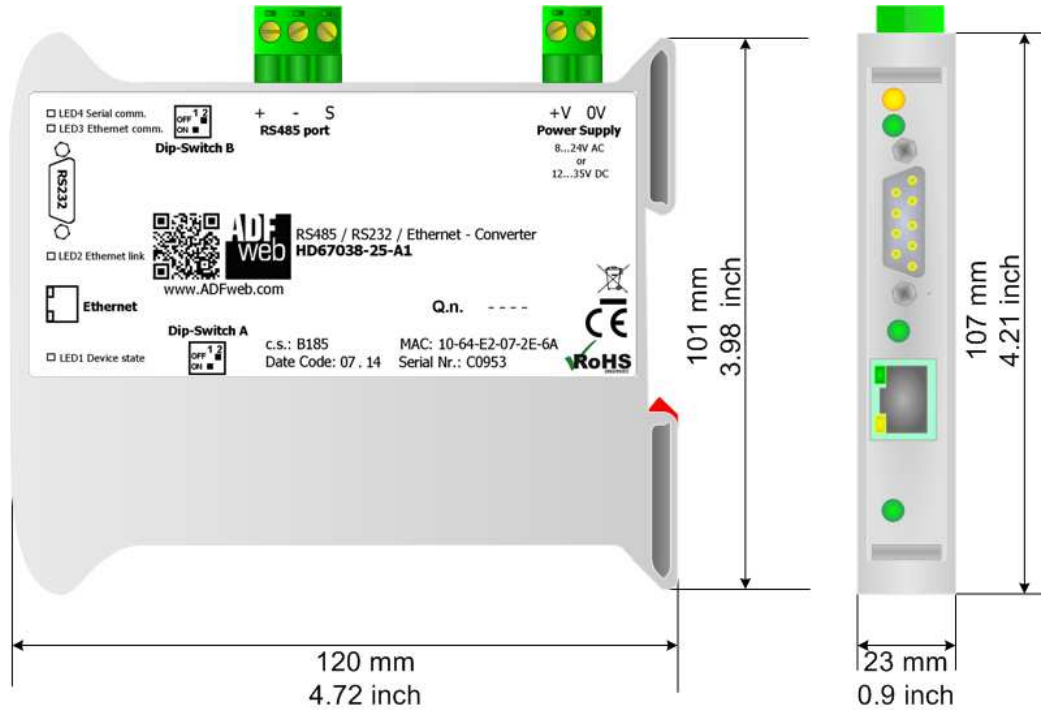

Housing: PVC
Weight: 200g (Approx)

Figure 10: Mechanical dimensions scheme for HD67038-xx-A1

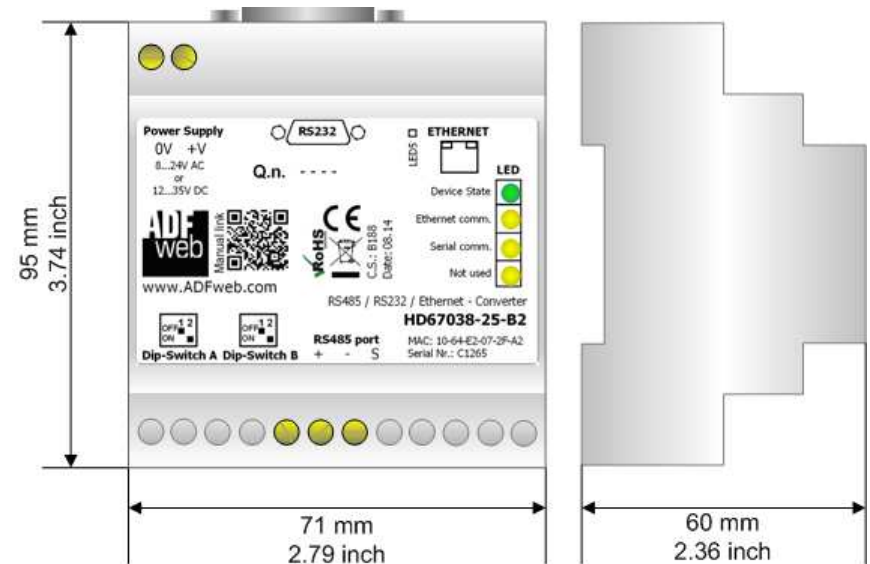

Housing: PVC
Weight: 200g (Approx)

Figure 11: Mechanical dimensions scheme for HD67038-xx-B2

ORDERING INFORMATIONS:

The ordering part number is formed by a valid combination of the following:

HD67038 - xx - x x

Connectors Type

- 1: Removable 5mm Screw Terminal
- 2: Fixed 5mm Screw Terminal

Enclosure Type

- A: 1M, 35mm DIN Rail mounting
- B: 4M, 35mm DIN Rail mounting

Serial Port:

- 2: RS232 on D-sub connector (type DE-9 Male)
- 5: RS485 on Removable 5mm Screw Terminal connector
- 4: RS422 on Removable 5mm Screw Terminal connector
- 25: RS232 on D-sub connector (type DE-9 Male) + RS485 on Removable 5mm Screw Terminal connector
- 24: RS232 on D-sub connector (type DE-9 Male) + RS422 on Removable 5mm Screw Terminal connector

Device Family

HD67038: RS485 / RS232 / Ethernet - Converter

- Order Code: **HD67038-2-A1** - RS232 / Ethernet - Converter (Housing type: A)
- Order Code: **HD67038-5-A1** - RS485 / Ethernet - Converter (Housing type: A)
- Order Code: **HD67038-4-A1** - RS422 / Ethernet - Converter (Housing type: A)
- Order Code: **HD67038-25-A1** - RS485 / RS232 / Ethernet - Converter (Housing type: A)
- Order Code: **HD67038-24-A1** - RS422 / RS232 / Ethernet - Converter (Housing type: A)
- Order Code: **HD67038-2-A1** - RS232 / Ethernet - Converter (Housing type: A)
- Order Code: **HD67038-5-B2** - RS485 / Ethernet - Converter (Housing type: A)
- Order Code: **HD67038-4-B2** - RS422 / Ethernet - Converter (Housing type: A)
- Order Code: **HD67038-25-B1** - RS485 / RS232 / Ethernet - Converter (Housing type: A)

DISCLAIMER:

All technical content within this document can be modified without notice. The content of the document is a under continual renewal. For losses due to fire, earthquake, third party access or other accidents, or intentional or accidental abuse, misuse, or use under abnormal conditions repairs are charged to the user. ADFweb.com S.r.l. will not be liable for accidental loss of use or inability to use this product, such as loss of business income. ADFweb.com S.r.l. shall not be liable for consequences of improper use.

OTHER REGULATIONS AND STANDARDS:**WEEE INFORMATION**

Disposal of old electrical and electronic equipment (as in the European Union and other European countries with separate collection systems).

— This symbol on the product or on its packaging indicates that this product may not be treated as household rubbish. Instead, it should be taken to an applicable collection point for the recycling of electrical and electronic equipment. If the product is disposed correctly, you will help prevent potential negative environmental factors and impact of human health, which could otherwise be caused by inappropriate disposal. The recycling of materials will help to conserve natural resources. For more information about recycling this product, please contact your local city office, your household waste disposal service or the shop where you purchased the product.

RESTRICTION OF HAZARDOUS SUBSTANCES DIRECTIVE

The device respects the 2002/95/EC Directive on the restriction of the use of certain hazardous substances in electrical and electronic equipment (commonly referred to as Restriction of Hazardous Substances Directive or RoHS).

CE MARKING

The product conforms with the essential requirements of the applicable EC directives.

WARRANTIES AND TECHNICAL SUPPORT:

For fast and easy technical support for your ADFweb.com SRL products, consult our internet support at www.adfweb.com.
Otherwise contact us at the address support@adfweb.com

RETURN POLICY:

If while using your product you have any problem and you wish to exchange or repair it, please do the following:

- Obtain a Product Return Number (PRN) from our internet support at www.adfweb.com. Together with the request, you need to provide detailed information about the problem.
- Send the product to the address provided with the PRN, having prepaid the shipping costs (shipment costs billed to us will not be accepted).

If the product is within the warranty of twelve months, it will be repaired or exchanged and returned within three weeks. If the product is no longer under warranty, you will receive a repair estimate.



ADFweb.com S.r.l.
Via Strada Nuova, 17
IT-31010 Mareno di Piave
TREVISO (Italy)
Phone +39.0438.30.91.31
Fax +39.0438.49.20.99
www.adfweb.com

