

User Manual

Revision 1.000

English

CAN / Optic Fiber – Repeater – Extender bus line (with filter data configurable)

(Order Code: HD67221FSX)

Benefits and Main Features:

- ⊕ Different baud rate of CAN branches
- ⊕ Very easy to configure
- ⊕ Triple electrical isolation
- ⊕ Protocol independent, allowing it to work with all the different CAN protocols and frame lengths
- ⊕ Temperature range: -40°C/85°C (-40°F/185°F)



User Manual

All Repeaters

See also the following links:

- www.adfweb.com?Product=HD67117F
- www.adfweb.com?Product=HD67117FSX (For CANopen)
- www.adfweb.com?Product=HD67180F (For DeviceNet)
- www.adfweb.com?Product=HD67180FSX (For DeviceNet)
- www.adfweb.com?Product=HD67181F (For CAN 2.0A & 2.0B)
- www.adfweb.com?Product=HD67181FSX (For CAN 2.0A & 2.0B)
- www.adfweb.com?Product=HD67182F (For J1939)
- www.adfweb.com?Product=HD67182FSX (For J1939)

Copper Cables Repeaters

See also the following links:

- www.adfweb.com?Product=HD67117 (For CANopen)
- www.adfweb.com?Product=HD67180 (For DeviceNet)
- www.adfweb.com?Product=HD67181 (For CAN 2.0A & 2.0B)
- www.adfweb.com?Product=HD67182 (For J1939)
- www.adfweb.com?Product=HD67221 (Filterate CAN to CAN)

Do you have an your customer protocol?

See the following links:

- www.adfweb.com?Product=HD67003

Do you need to choose a device? do you want help?

Ask it to the following link:

- www.adfweb.com?Cmd=helpme

INDEX:

	Page
INDEX	2
UPDATED DOCUMENTATION	2
REVISION LIST	2
WARNING	2
TRADEMARKS	2
SECURITY ALERT	3
EXAMPLE OF CONNECTION	4
CONNECTION SCHEME	5
CHARACTERISTICS	6
CONFIGURATION	6
POWER SUPPLY	7
FUNCTION MODES	8
LEDS	9
OPTIC FIBER	10
CAN	11
SET SWITCH BAUD RATE	12
ETHERNET	12
USE OF COMPOSITOR SW67221FSX	13
NEW PROJECT / OPEN PROJECT	14
SOFTWARE OPTIONS	15
SET COMMUNICATION	17
SET COBID ACCESS	18
UPDATE DEVICE	20
MECHANICAL DIMENSIONS	22
ORDER CODE	23
ACCESSORIES	23
DISCLAIMER	24
OTHER REGULATIONS AND STANDARDS	24
WARRANTIES AND TECHNICAL SUPPORT	25
RETURN POLICY	25

UPDATED DOCUMENTATION:

Dear customer, we thank you for your attention and we remind you that you need to check that the following document is:

- ✦ Updated
- ✦ Related to the product you own

To obtain the most recently updated document, note the “document code” that appears at the top right-hand corner of each page of this document.

With this “Document Code” go to web page www.adfweb.com/download/ and search for the corresponding code on the page. Click on the proper “Document Code” and download the updates.

REVISION LIST:

Revision	Date	Author	Chapter	Description
1.000	09/05/2016	Ff	All	First release version

WARNING:

ADFweb.com reserves the right to change information in this manual about our product without warning. ADFweb.com is not responsible for any error this manual may contain.

TRADEMARKS:

All trademarks mentioned in this document belong to their respective owners.

SECURITY ALERT:**GENERAL INFORMATION**

To ensure safe operation, the device must be operated according to the instructions in the manual. When using the device, legal and safety regulation are required for each individual application. The same applies also when using accessories.

INTENDED USE

Machines and systems must be designed so the faulty conditions do not lead to a dangerous situation for the operator (i.e. independent limit switches, mechanical interlocks, etc.).

QUALIFIED PERSONNEL

The device can be used only by qualified personnel, strictly in accordance with the specifications. Qualified personnel are persons who are familiar with the installation, assembly, commissioning and operation of this equipment and who have appropriate qualifications for their job.

RESIDUAL RISKS

The device is state-of-the-art and is safe. The instruments can represent a potential hazard if they are inappropriately installed and operated by untrained personnel. These instructions refer to residual risks with the following symbol:



This symbol indicates that non-observance of the safety instructions is a danger for people that could lead to serious injury or death and / or the possibility of damage.

CE CONFORMITY

The declaration is made by our company. You can send an email to support@adfweb.com or give us a call if you need it.

EXAMPLE OF CONNECTION:

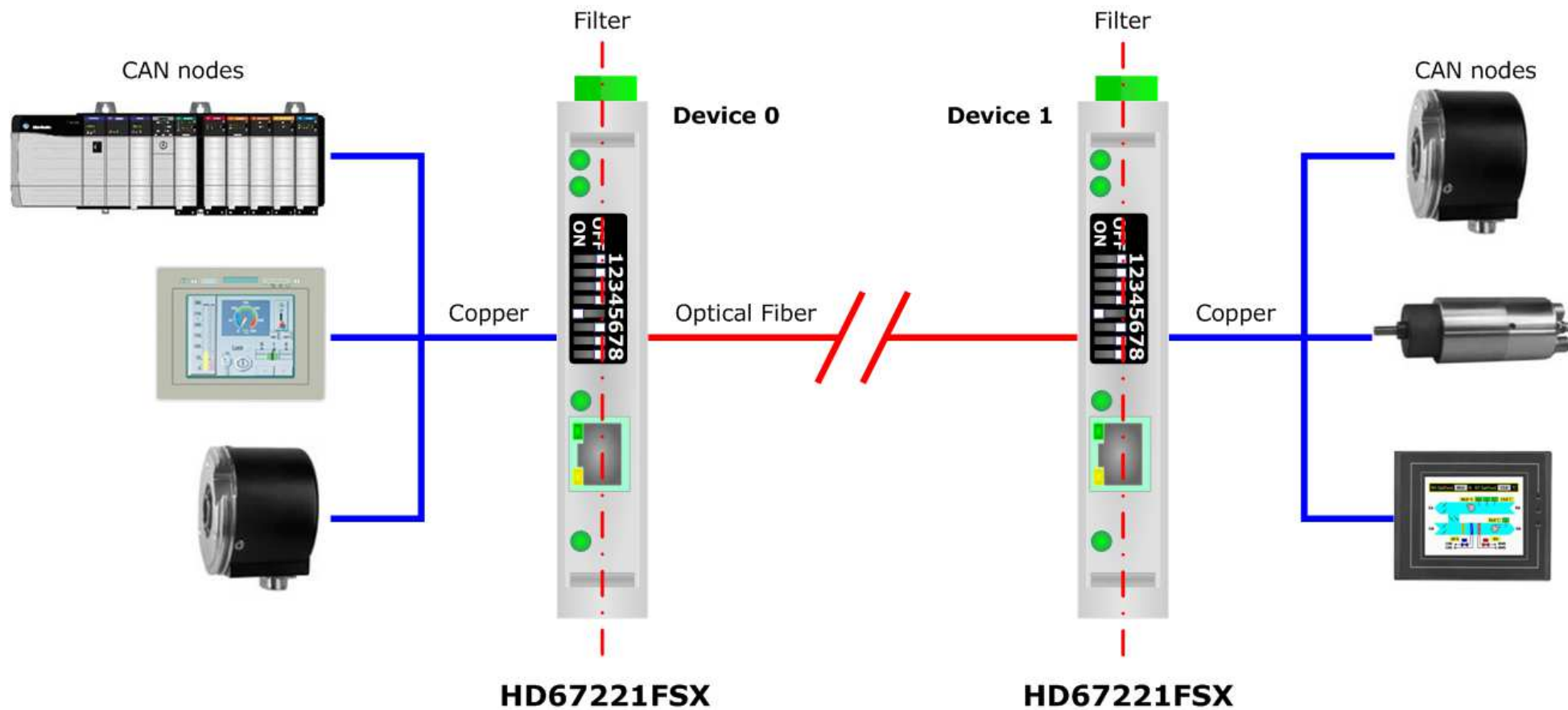

CONNECTION SCHEME:

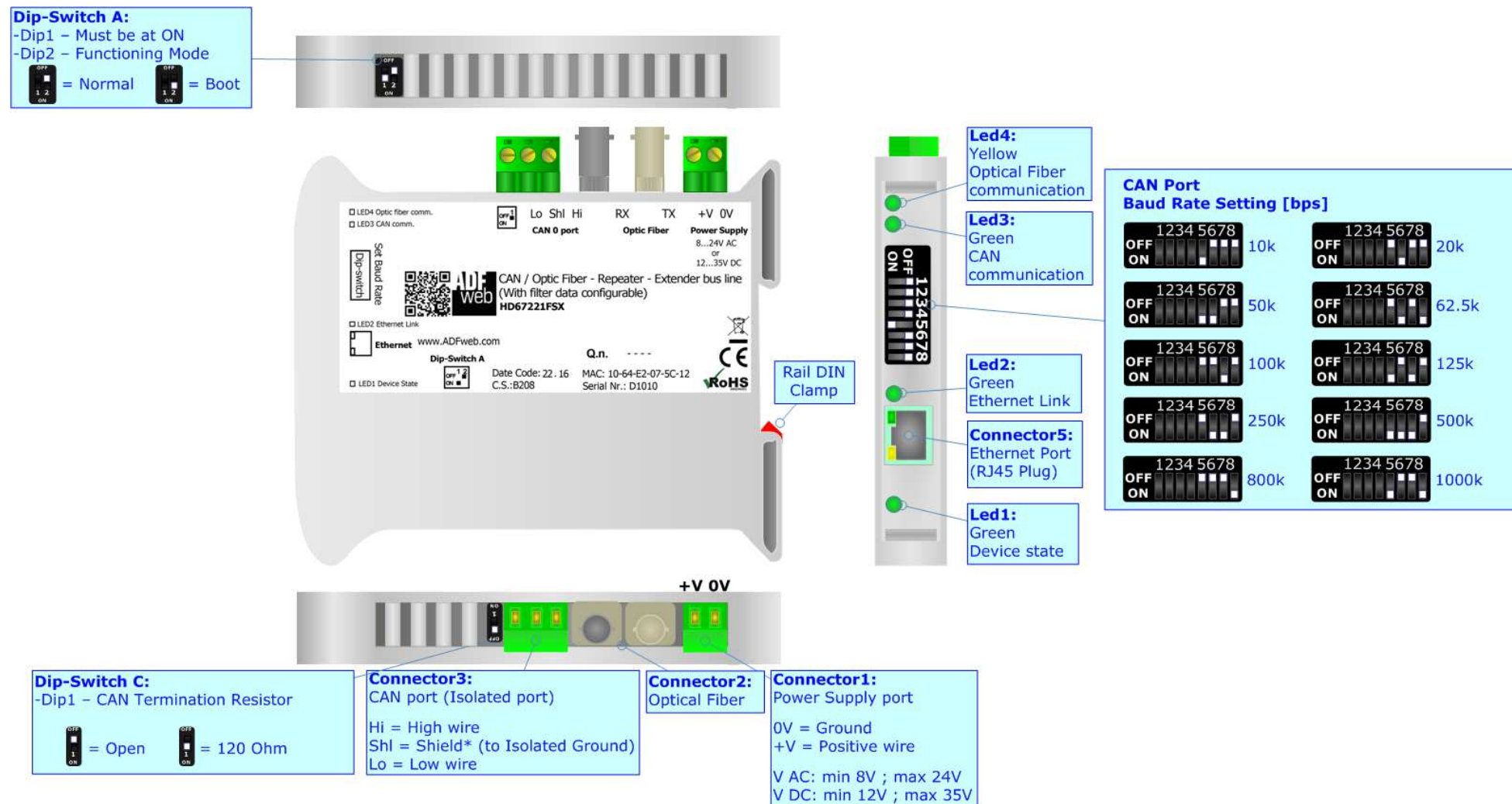

Figure 1: Connection scheme for HD67221FSX

CHARACTERISTICS:

The HD67221FSX is a configurable CAN COB-ID filter repeaters.

They have the following characteristics:

- ➔ Electrical isolation between two buses;
- ➔ Two-directional information between two distinct CAN buses;
- ➔ Mountable on 35mm Rail DIN;
- ➔ Filter of CAN frames;
- ➔ Wide power supply input range: 8...24V AC or 12...35V DC;
- ➔ Wide temperature range: -40°C / 85°C [-40°F / +185°F].

CONFIGURATION:

You need Compositor SW67221FSX software on your PC in order to perform the following:

- ➔ Define the parameters of CAN line;
- ➔ Define the filter map of COB-ID that can pass through the Repeater;
- ➔ Update the device.

POWER SUPPLY:

The devices can be powered at 8...24V AC and 12...35V DC. For more details see the two tables below.

VAC 		VDC 	
Vmin	Vmax	Vmin	Vmax
8	24V	12V	35V

Consumption at 24V DC:

Device	Consumption [W/VA]
HD67221FSX	3.5

Caution: Do not reverse the polarity power

Connector1:
 Power Supply port
 0V = Ground
 +V = Positive wire
 V AC: min 8V ; max 24V
 V DC: min 12V ; max 35V

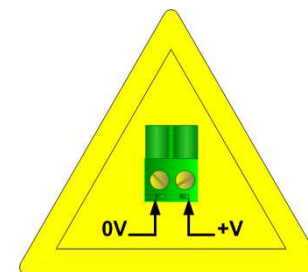

HD67221FSX

FUNCTION MODES:

The device has got two function modes depending on the position of the 'Dip2 of Dip-Switch A':

- The first, with 'Dip2 of Dip-Switch A' at "OFF" position, is used for the normal working of the device.
- The second, with 'Dip2 of Dip-Switch A' at "ON" position, is used for uploading the Project and/or Firmware.

For the operations to follow for the updating, see 'UPDATE DEVICE' section.

According to the functioning mode, the LEDs will have specific functions, see 'LEDS' section.



LEDS:

The devices have got four green LEDs that are used to give information of the functioning status. The various meanings of the LEDs are described in the table below.

LED	Normal Mode	Boot Mode
1: Device State (green)	Blinks slowly (~1Hz)	Blinks quickly: Boot state
2: Ethernet Link (green)	ON: Ethernet cable connected OFF: Ethernet cable disconnected	ON: Ethernet cable connected OFF: Ethernet cable disconnected
3: CAN communication (green)	Changes state when a CAN message arrives	Blinks quickly: Boot state
4: Optic Fiber Communication (green)	Changes state when a Optic Fiber message arrives	Blinks quickly: Boot state

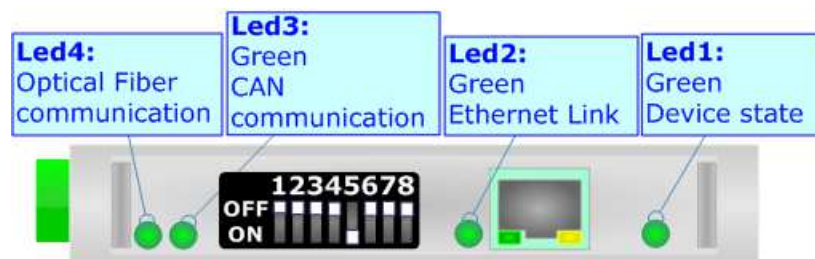

OPTICAL FIBER:

The fiber optic connection must be made with a 62.5/125 μ m multi-mode fiber equipped with ST connector.



CAN:

For terminating the CAN line with a 120Ω resistor it is necessary that the Dip1 of 'Dip-Switch C' is at ON position (for the FSX serie) and that the Jumper1 is at "120Ohm" position (for the F serie).



Cable characteristics:

DC parameter:	Impedance	70 Ohm/m
AC parameters:	Impedance	120 Ohm/m
	Delay	5 ns/m
Length	Baud Rate [bps]	Length MAX [m]
	10 K	5000
	20 K	2500
	50 K	1000
	100 K	650
	125 K	500
	250 K	250
	500 K	100
	800 K	50
	1000 K	25

Baud rate selected by Dip-Switch

The baud rate of “CAN” could be defined through the dip-switch present in device. These are the possible combinations:

Dip n° 5, 6, 7, 8 “CAN” setting.

Speed “CAN 1”	Dip 5	Dip 6	Dip 7	Dip 8
10K	ON	OFF	OFF	OFF
20K	OFF	ON	OFF	OFF
50K	ON	ON	OFF	OFF
100K	OFF	OFF	ON	OFF
125K	ON	OFF	ON	OFF
250K	OFF	ON	ON	OFF
500K	ON	ON	ON	OFF
800K	OFF	OFF	OFF	ON
1000K	ON	OFF	OFF	ON

ETHERNET:

The Ethernet port is used for the firmware updating of the HD67221FSX.

The Ethernet connection must be made using Connector5 of HD67221FSX with at least a Category 5E cable. The maximum length of the cable should not exceed 100m. The cable has to conform to the T568 norms relative to connections in cat.5 up to 100 Mbps. To connect the device to a Hub/Switch the use of a straight cable is recommended. To connect the device to a PC/PLC/other the use of a cross cable is recommended.

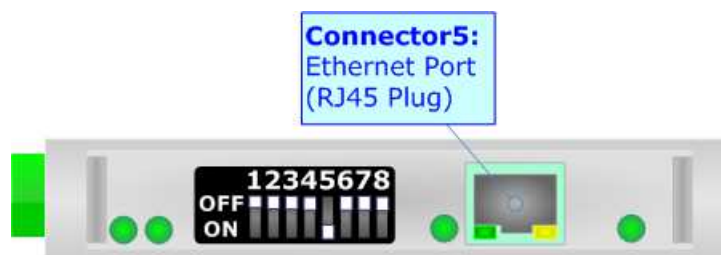

USE OF COMPOSITOR SW67221FSX:

To configure the Converter, use the available software that runs with Windows called SW67221FSX. It is downloadable on the site www.adfweb.com and its operation is described in this document. *(This manual is referenced to the last version of the software present on our web site).* The software works with MSWindows (XP, Vista, Seven, 8, 10; 32/64bit).

When launching the SW67221FSX, the window below appears (Fig. 2).

 **Note:**
It is necessary to have installed .Net Framework 4.

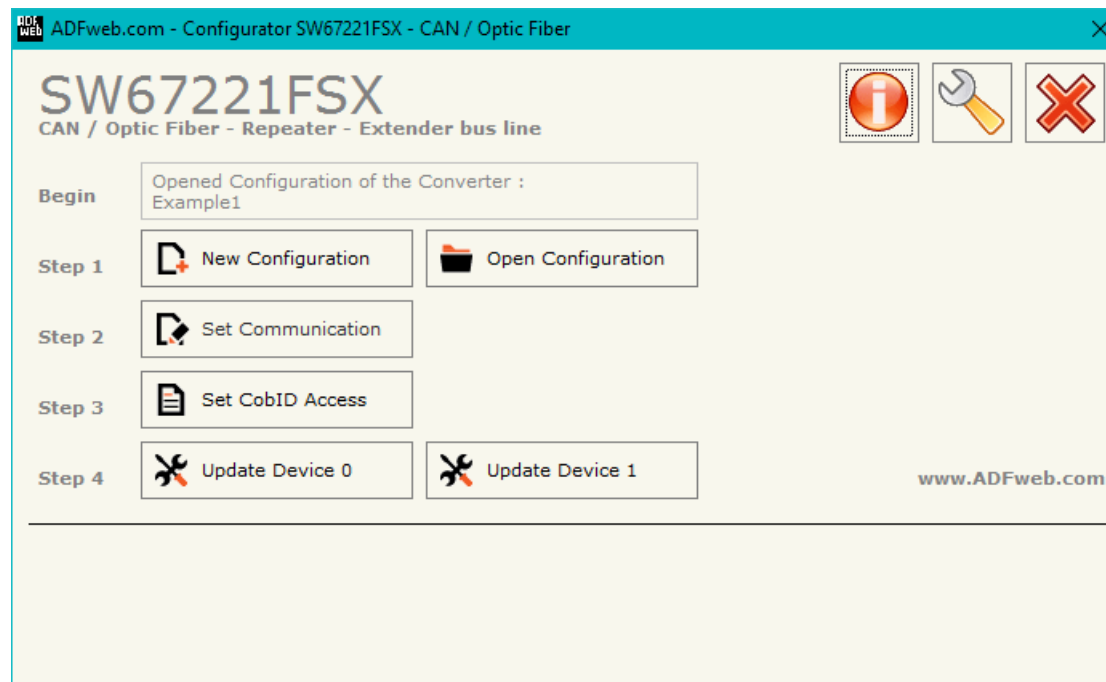
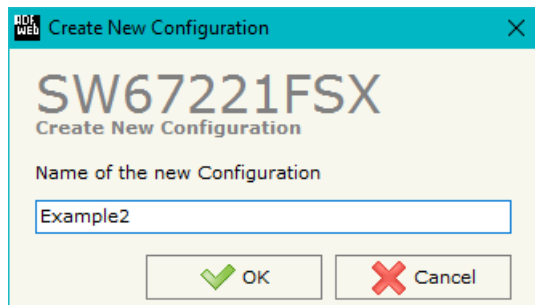

Figure 2: Main window for SW67221FSX

NEW CONFIGURATION / OPEN CONFIGURATION:

The “**New Configuration**” button creates the folder which contains the entire device’s configuration.



A device’s configuration can also be imported or exported:

- To clone the configurations of a programmable “CAN / Optic Fiber – Repeater – with filter data configurable” in order to configure another device in the same manner, it is necessary to maintain the folder and all its contents;
- To clone a project in order to obtain a different version of the project, it is sufficient to duplicate the project folder with another name and open the new folder with the button “**Open Configuration**”.

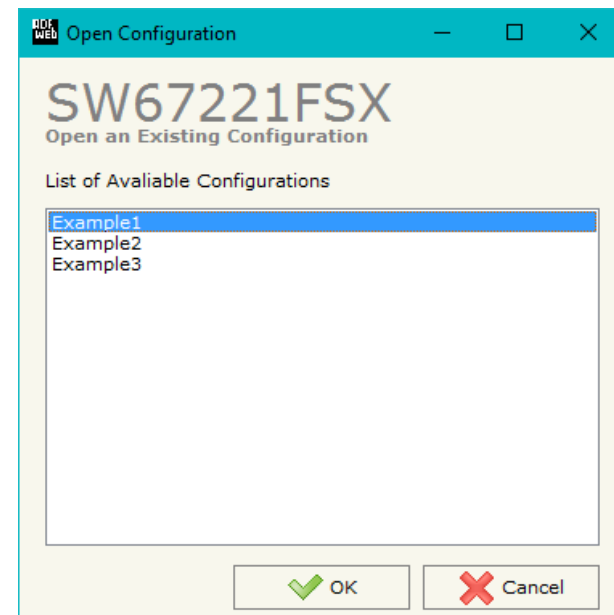

SOFTWARE OPTIONS:

By pressing the “**Settings**” () button there is the possibility to change the language of the software and check the updatings for the compositor.

In the section “Language” it is possible to change the language of the software.

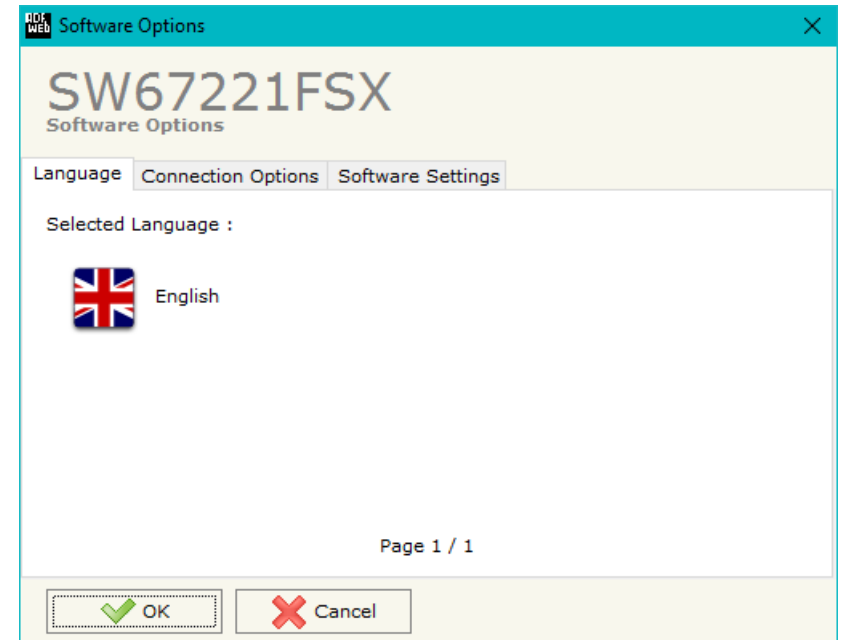
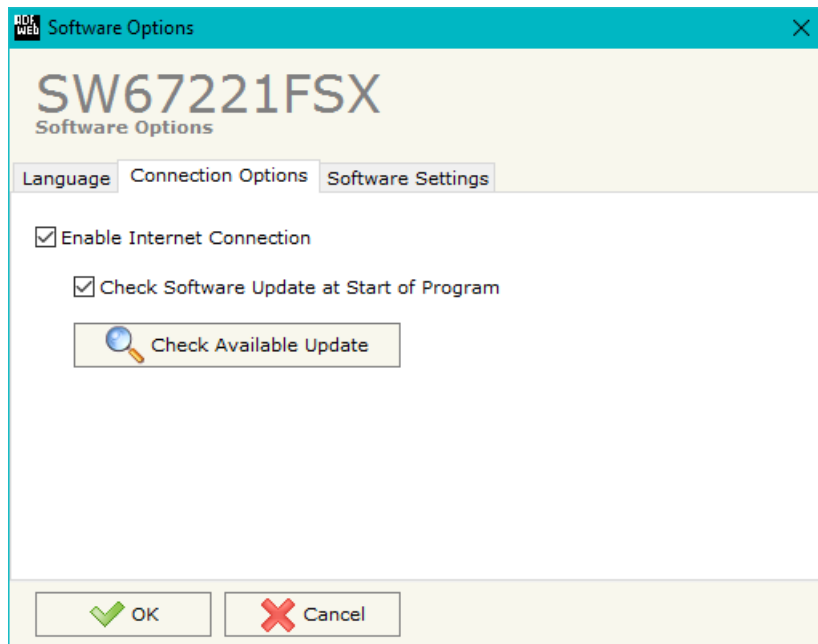

In the section “Connection Options”, it is possible to check if there are some updatings of the software compositor in ADFweb.com website. Checking the option “**Check Software Update at Start of Program**”, the SW67221FSX check automatically if there are updatings when it is launched.

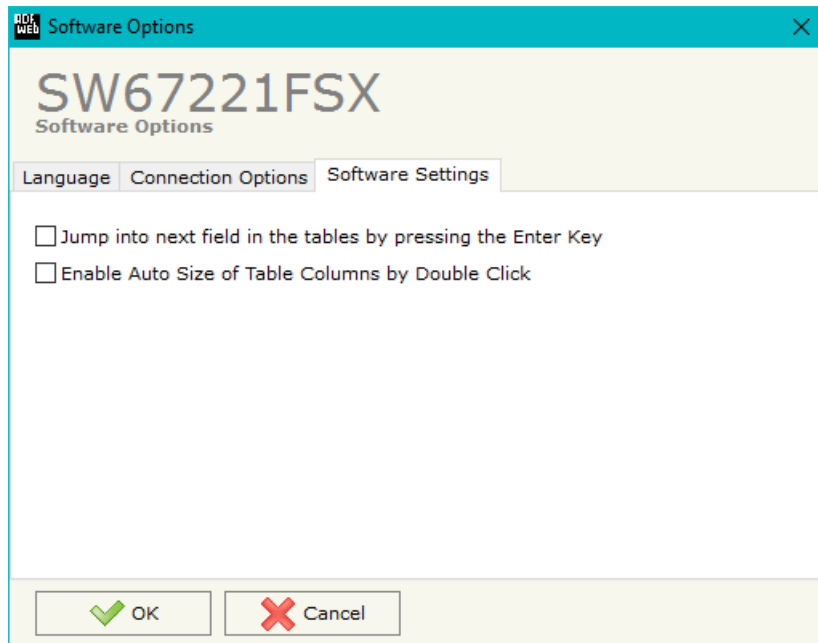

In the section “Software Settings”, it is possible to enable/disable some keyboard’s commands for an easier navigation inside the tables contained in the different sections of the software.

SET COMMUNICATION:

This section define the fundamental communication parameters of converter.

By Pressing the **“Set Communication”** button from the main window for SW67221FSX (Fig. 2) the window **“Set Communication”** appears (Fig. 3).

The window is divided in different sections, the first is used for setting the parameters of Device 0, the second for setting the parameters of Device 1 and the other for selecting Ethernet network parameters.

The means of the fields for **“Device 0”** and **“Device 1”** are:

- If the field **“Baudrate set with Dip Switch”** is checked, the baud rate is taken from the position of Dip-Switch in the front of the converter. Otherwise if it isn’t checked, you have to select the baud rate from the list in the field **“Baudrate”**.

If the field **“Positive Implementation”** is checked, only the CobIDs that are written in the **“Set CobID Access”** table passes in the other CAN bus; otherwise if the field isn’t checked, all the CobID written in the table are blocked by the Repeater.

The means of the fields for **“Ethernet Device 0”** and **“Ethernet Device 1”** are:

- In the field **“IP ADDRESS”**, the IP address of the Ethernet side is defined;
- In the field **“SUBNET Mask”**, SubNet Mask of the Ethernet network is defined;
- If the field **“GATEWAY”** is checked, insert the default gateway that you want to use. This feature can be enabled or disabled pressing the Check Box field. This feature is used for programming the device remotely.

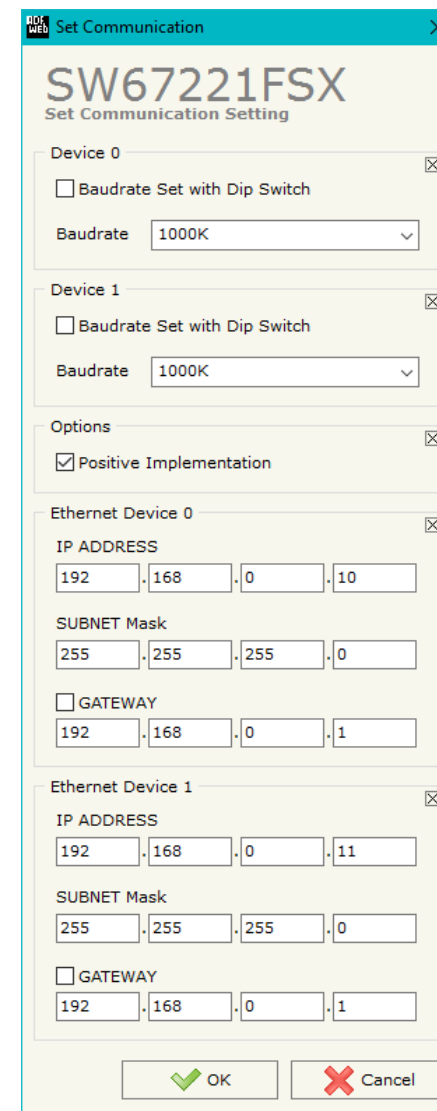

Figure 3: **“Set Communication”** window

SET COBID ACCESS:

The following parameters can be defined:

- Which CAN frames of the “Device 0” pass into “Device 1”;
- Which CAN frames of the “Device 1” pass into “Device 0”.

If the “Positive Implementation” parameter is set, it is possible to change the CobID of the frame when it passes from one Device to the other. In order to do this it is necessary to insert the new CobID in the “Modify CobID” column. The dimension of data and its value do not change when it passes into the Repeater.

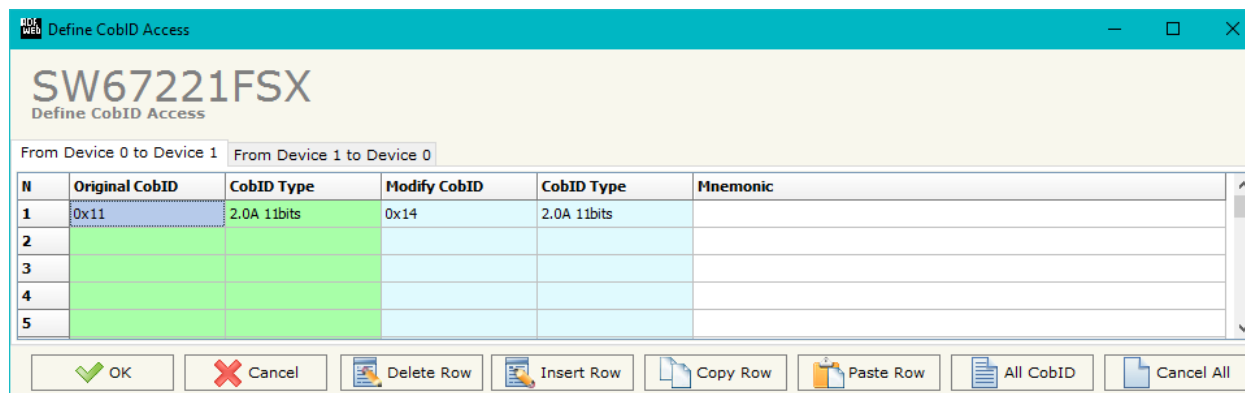

Figure 4: “Set CobID Access” window

The data of the columns have the following meaning:

- In the field “**Original CobID**” insert the CobID that can pass in the other CAN network (if Positive Implementation is not checked then the indicated CobID cannot pass to other CAN Network);
- In the field “**CobID Type**” insert the type of CobID (CAN 2.0A 11 bits or CAN 2.0B 29 bits);
- In the field “**Modify CobID**” insert the new CobID of the frame that passes in the other CAN network (only if “Positive Implementation” is checked);
- In the field “**CobID Type**” insert the type of CobID (CAN 2.0A 11 bits or CAN 2.0B 29 bits);
- In the field “**Mnemonic**” you can insert the description of the Can Frame.

Example 1:

If you want to pass the CobID 0x181 from "Device 0" to "Device 1" and set it like 0x189 in "Device 1", you need to set the follow parameter in table "CAN 0 to CAN1":

- ➔ Original CobID 0x181;
- ➔ Modify CobID 0x189.

In the above example:
 All the Can frames with CobID different from the "Original CobID" column are blocked. The Can frames with CobID equal to the "Original CobID" column are sent to "Device 1" with the new CobID.

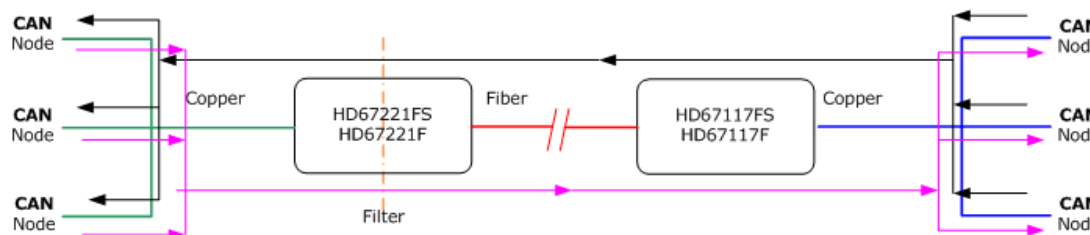

UPDATE DEVICE:

By pressing the **"Update Device 0"** or **"Update Device 1"** button, it is possible to load the created Configuration into the devices; and also the Firmware, if necessary.

If you don't know the actual IP address of the device you have to use this procedure:

- Turn off the Device;
- Put Dip2 of 'Dip-Switch A' in ON position;
- Turn on the device
- Connect the Ethernet cable;
- Insert the IP **"192.168.2.205"**;
- Press the **"Ping"** button, "Device Found! must appear";
- Press the **"Next"** button;
- Select which operations you want to do;
- Press the **"Execute update firmware"** button to start the upload;
- When all the operations are "OK" turn off the Device;
- Put Dip2 of 'Dip-Switch A' in OFF position;
- Turn on the device.

At this point the configuration/firmware on the device is correctly updated.

If you know the actual IP address of the device, you have to use this procedure:

- Turn on the Device with the Ethernet cable inserted;
- Insert the actual IP of the Converter;
- Press the **"Ping"** button, must appear "Device Found!";
- Press the **"Next"** button;
- Select which operations you want to do;
- Press the **"Execute update firmware"** button to start the upload;
- When all the operations are "OK" the device automatically goes at Normal Mode.

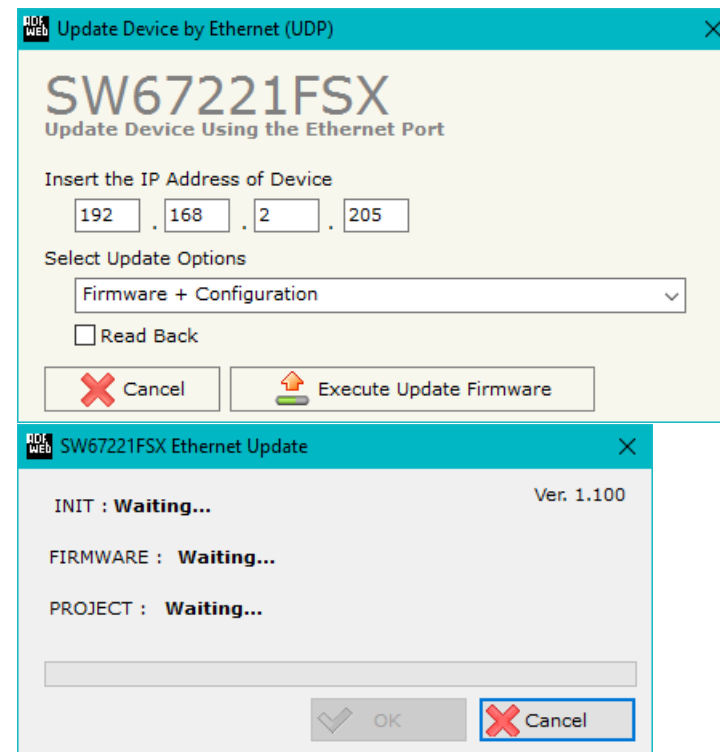





Figure 4: "Update Device" windows

 **Note:**
When you install a new version of the software, if it is the first time it is better you do the update of the Firmware in the HD67221FSX device.

 **Note:**
When you receive the device, for the first time, you also have to update the Firmware in the HD67221FSX device.

 **Warning:**
If Fig. 5 appears when you try to do the Update try these points before seeking assistance:

- Try to repeat the operations for the updating;
- Try with another PC;
- Try to restart the PC;
- Check the LAN settings;
- If you are using the program inside a Virtual Machine, try to use in the main Operating System;
- If you are using Windows Seven, Vista, 8 or 10 make sure that you have the administrator privileges;
- In case you have to program more than one device, using the "UDP Update", you have to cancel the ARP table every time you connect a new device on Ethernet. For do this you have to launch the "Command Prompt" and write the command "arp -d". Pay attention that with Windows Vista, Seven, 8 you have to launch the "Command Prompt" with Administrator Rights;
- Pay attention at Firewall lock.

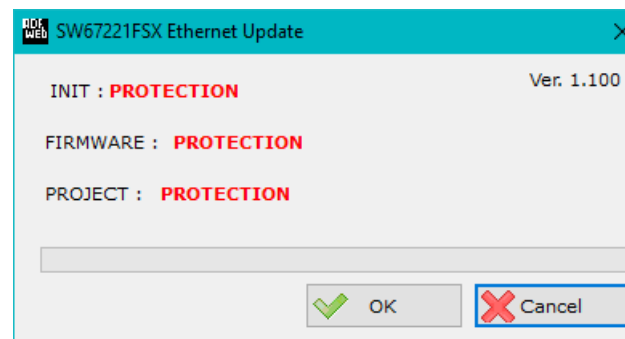
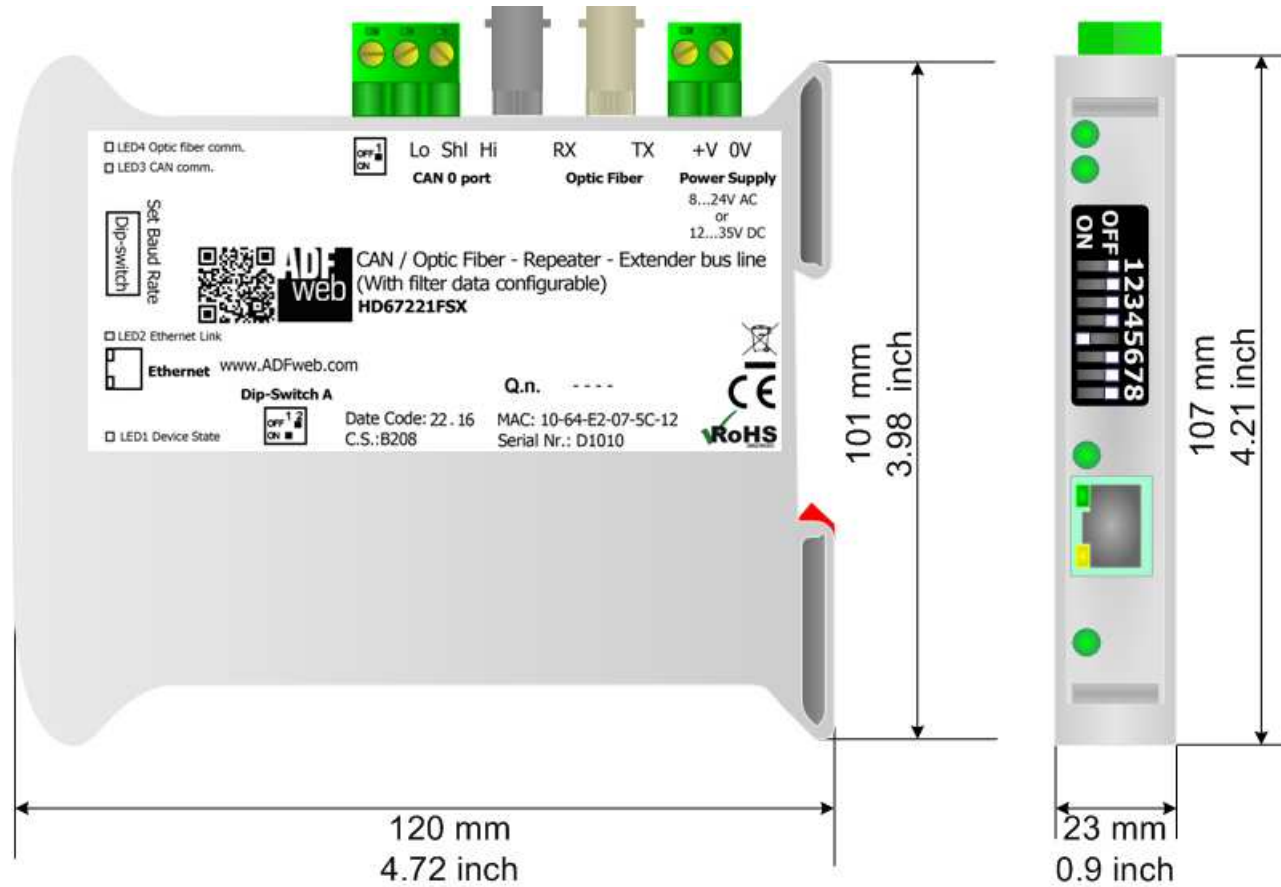

Figure 5: "Protection" windows

In the case of HD67221FSX you have to use the software "SW67221FSX": www.adfweb.com/download/filefold/SW67221FSX.zip.

MECHANICAL DIMENSIONS:



Housing: PVC
Weight: 200g (Approx)

Figure 6: Mechanical dimensions for HD67221FSX



ORDER CODE:

Order Code: **HD67221FSX** - CAN / Optic Fiber - Repeater - Extender bus line - (With filter data configurable)

ACCESSORIES:

- AC34001** - Power Supply 220/12V AC 50/60Hz
- AC34002** - Power Supply 110/12V AC 50/60Hz
- AC34021** - Patch Cable Optic Fibres ST/ST 2Mts
- AC34022** - Patch Cable Optic Fibres ST/ST 10Mts

DISCLAIMER:

All technical content within this document can be modified without notice. The content of the document is a under continual renewal. For losses due to fire, earthquake, third party access or other accidents, or intentional or accidental abuse, misuse, or use under abnormal conditions repairs are charged to the user. ADFweb.com S.r.l. will not be liable for accidental loss of use or inability to use this product, such as loss of business income. ADFweb.com S.r.l. shall not be liable for consequences of improper use.

OTHER REGULATIONS AND STANDARDS:**WEEE INFORMATION**

Disposal of old electrical and electronic equipment (as in the European Union and other European countries with separate collection systems).

■ This symbol on the product or on its packaging indicates that this product may not be treated as household rubbish. Instead, it should be taken to an applicable collection point for the recycling of electrical and electronic equipment. If the product is disposed correctly, you will help prevent potential negative environmental factors and impact of human health, which could otherwise be caused by inappropriate disposal. The recycling of materials will help to conserve natural resources. For more information about recycling this product, please contact your local city office, your household waste disposal service or the shop where you purchased the product.

RESTRICTION OF HAZARDOUS SUBSTANCES DIRECTIVE

The device respects the 2002/95/EC Directive on the restriction of the use of certain hazardous substances in electrical and electronic equipment (commonly referred to as Restriction of Hazardous Substances Directive or RoHS).

CE MARKING

The product conforms with the essential requirements of the applicable EC directives.

WARRANTIES AND TECHNICAL SUPPORT:

For fast and easy technical support for your ADFweb.com SRL products, consult our internet support at www.adfweb.com. Otherwise contact us at the address support@adfweb.com

RETURN POLICY:

If while using your product you have any problem and you wish to exchange or repair it, please do the following:

- Obtain a Product Return Number (PRN) from our internet support at www.adfweb.com. Together with the request, you need to provide detailed information about the problem.
- Send the product to the address provided with the PRN, having prepaid the shipping costs (shipment costs billed to us will not be accepted).

If the product is within the warranty of twelve months, it will be repaired or exchanged and returned within three weeks. If the product is no longer under warranty, you will receive a repair estimate.



ADFweb.com S.r.l.
Via Strada Nuova, 17
IT-31010 Mareno di Piave
TREVISO (Italy)
Phone +39.0438.30.91.31
Fax +39.0438.49.20.99
www.adfweb.com

