

User Manual

Revision 2.101
English

CAN / Modbus Master – Converter

(Order Code: HD67411)

For Website information:

www.adfweb.com?Product=HD67411

For Price information:

www.adfweb.com?Price=HD67411

Benefits and Main Features:

- ✦ Very easy to configure
- ✦ Wide supply input range
- ✦ Electrical isolation
- ✦ Industrial temperature range:
- ✦ -40°C / 105°C (-40°F / 221°F)



For other Gateways / Bridges:

CAN from/to Modbus

See also the following links:

- www.adfweb.com?product=HD67012 (Modbus RTU Slave)
- www.adfweb.com?product=HD67514 (Modbus TCP Master)
- www.adfweb.com?product=HD67515 (Modbus TCP Slave)

CANopen from/to Modbus

See also the following links:

- www.adfweb.com?product=HD67001 (Modbus RTU Master)
- www.adfweb.com?product=HD67502 (Modbus RTU Slave)
- www.adfweb.com?product=HD67504 (Modbus TCP Master)
- www.adfweb.com?product=HD67505 (Modbus TCP Slave)

Do you have an your customer protocol?

See the following links:

www.adfweb.com?Product=HD67003

Do you need to choose a device? do you want help?

Ask it to the following link:

www.adfweb.com?Cmd=helpme



User Manual

INDEX:

	Page
INDEX	2
UPDATED DOCUMENTATION	2
REVISION LIST	2
WARNING	2
TRADEMARKS	2
SECURITY ALERT	3
EXAMPLE OF CONNECTION	4
CONNECTION SCHEME	5
CHARACTERISTICS	7
CONFIGURATION	7
POWER SUPPLY	8
LEDS	9
RS485	10
CAN	11
USB	12
USE OF COMPOSITOR SW67411	13
NEW PROJECT / OPEN PROJECT	14
SOFTWARE OPTIONS	15
SET COMMUNICATION	17
COB REQUEST	18
COB SETTING	20
UPDATE DEVICE	22
UPDATE DEVICE USB	23
MECHANICAL DIMENSIONS	25
ORDER CODE	29
ACCESSORIES	30
DISCLAIMER	31
OTHER REGULATIONS AND STANDARDS	31
WARRANTIES AND TECHNICAL SUPPORT	32
RETURN POLICY	32

UPDATED DOCUMENTATION:

Dear customer, we thank you for your attention and we remind you that you need to check that the following document is:

- ✦ Updated
- ✦ Related to the product you own

To obtain the most recently updated document, note the “document code” that appears at the top right-hand corner of each page of this document.

With this “Document Code” go to web page www.adfweb.com/download/ and search for the corresponding code on the page. Click on the proper “Document Code” and download the updates.

REVISION LIST:

Revision	Date	Author	Chapter	Description
2.000	24/04/2012	Fl	All	New mechanical dimensions
2.001	07/02/2013	Nt	All	Added new chapters
2.100	04/08/2016	Ff	All	New hardware version
2.101	13/03/2017	Ff	All	Revision

WARNING:

ADFweb.com reserves the right to change information in this manual about our product without warning. ADFweb.com is not responsible for any error this manual may contain.

TRADEMARKS:

All trademarks mentioned in this document belong to their respective owners.

SECURITY ALERT:**GENERAL INFORMATION**

To ensure safe operation, the device must be operated according to the instructions in the manual. When using the device, legal and safety regulation are required for each individual application. The same applies also when using accessories.

INTENDED USE

Machines and systems must be designed so the faulty conditions do not lead to a dangerous situation for the operator (i.e. independent limit switches, mechanical interlocks, etc.).

QUALIFIED PERSONNEL

The device can be used only by qualified personnel, strictly in accordance with the specifications. Qualified personnel are persons who are familiar with the installation, assembly, commissioning and operation of this equipment and who have appropriate qualifications for their job.

RESIDUAL RISKS

The device is state-of-the-art and is safe. The instruments can represent a potential hazard if they are inappropriately installed and operated by untrained personnel. These instructions refer to residual risks with the following symbol:



This symbol indicates that non-observance of the safety instructions is a danger for people that could lead to serious injury or death and / or the possibility of damage.

CE CONFORMITY

The declaration is made by our company. You can send an email to support@adfweb.com or give us a call if you need it.

EXAMPLE OF CONNECTION:

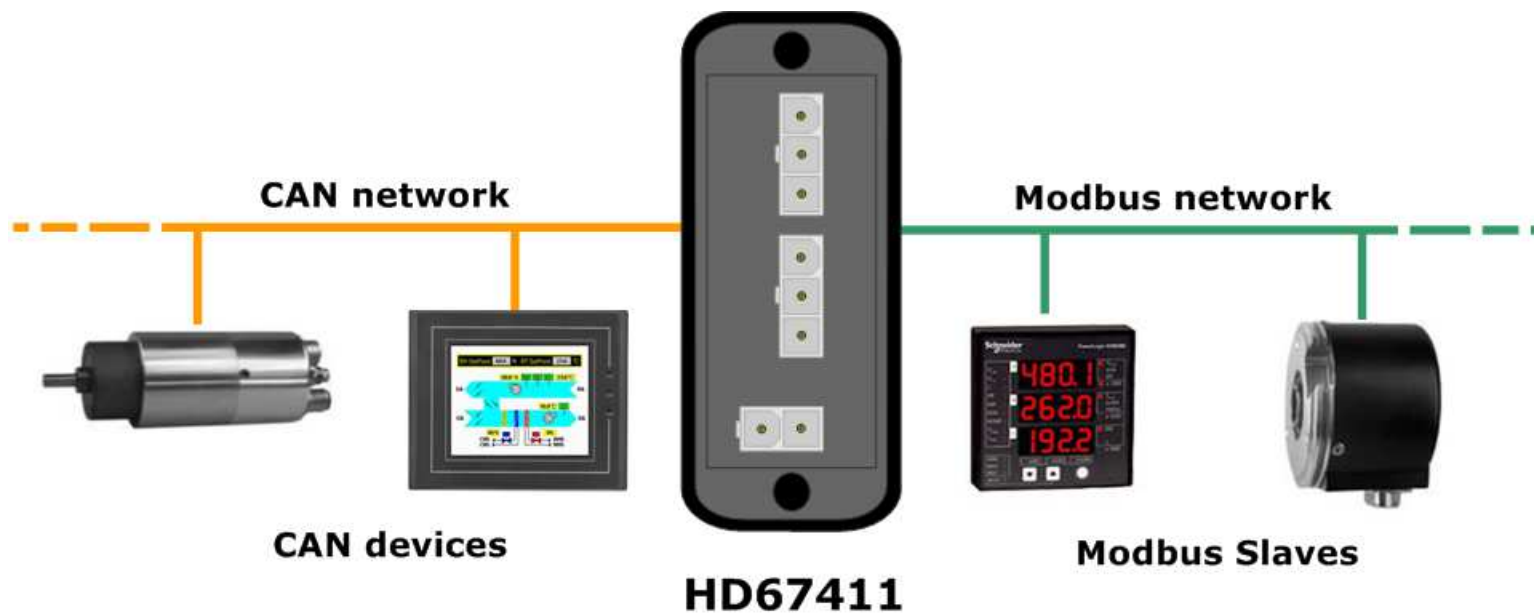

CONNECTION SCHEME:



Figure 1a: Connection scheme for HD67411-E4x-xxx

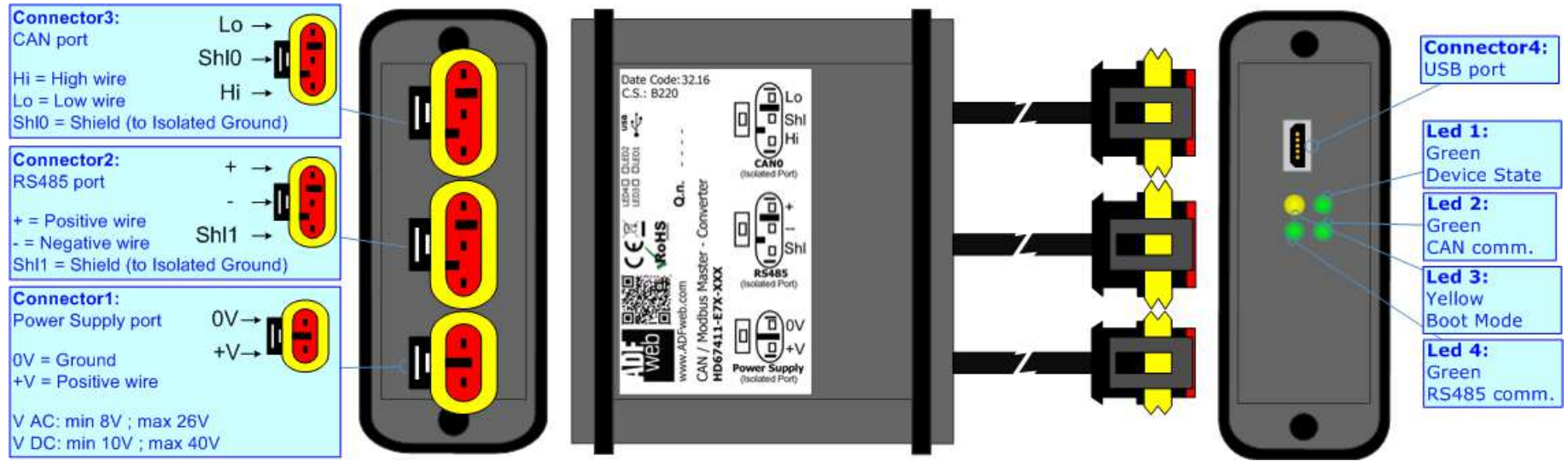

Figure 1b: Connection scheme for HD67411-E7x-xxx

CHARACTERISTICS:

The "HD67411" series are rugged devices used to interface CAN devices with Modbus Slaves.

With his particular enclosure, equipped with four fixing lugs, makes available the mounting of the device in any plane surface (horizontal, vertical, oblique).

It is possible to have the device varnished or totally resined and also in both cases with "Mini-Fit®" connectors or "AMP SuperSeal 1.5" connectors. If is resined, the enclosure, like the "AMP SuperSeal 1.5" connectors, is waterproof.

All the four series have these characteristics:

- Triple 4kV isolation between Power Supply / RS485 / CAN;
- Varnished / Resined (optionally);
- Wide power supply input range: 8...26V AC | 10...40V DC;
- Mini-Fit® / AMP SuperSeal 1.5 connectors;
- Metal enclosure with fixing lugs;
- Possibility to use Metal hose clamps for fixing it without using lugs;
- Microprocessor for data control;
- Wide temperature range: -40°C / 105°C (-40°F / 221°F).

CONFIGURATION:

You need Compositor SW67411 software on your PC in order to perform the following:

- Define the CAN frames read from Converter;
- Define the CAN frames write from the Converter;
- Define the Modbus requests in read;
- Define the Modbus requests in Write;
- Update the device.

POWER SUPPLY:

The devices can be powered between a wide range of tensions. For more details see the two tables below.

	VAC		VDC	
	Vmin	Vmax	Vmin	Vmax
HD67411-Exx-xxx	8V	26V	10V	40V

Consumption at 24V DC:

Device	W/VA
HD67411-Exx-xxx	4

Caution: Not reverse the polarity power

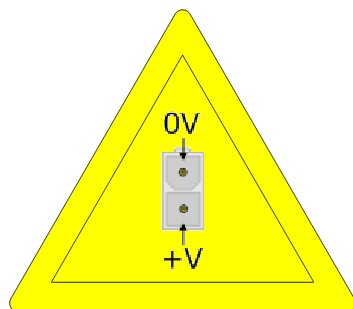

HD67411-E4x-xxx

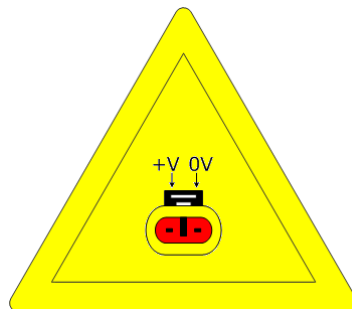

HD67411-E7x-xxx

Note: It is possible to use also negative tensions. In this case the polarity must be inverted.

Connector1:
Power Supply port

0V = Ground
+V = Positive wire

V AC: min 8V ; max 26V
V DC: min 10V ; max 40V



Connector1:
Power Supply port

+V 0V

0V = Ground
+V = Positive wire

V AC: min 8V ; max 26V
V DC: min 10V ; max 40V

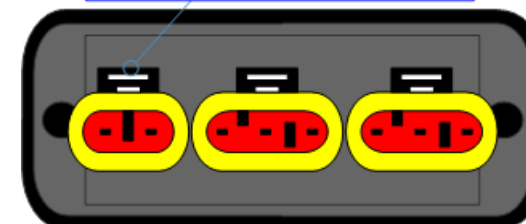

LEDS:

The device has got four LEDs that are used to give information of the functioning status. The various meanings of the LEDs are described in the table below.

LED	Normal Mode	Boot Mode
1: Device state (green)	Blinks slowly (~1Hz)	Blinks quickly: Boot state Blinks very slowly (~0.5Hz): update in progress
2: CAN Communication (green)	Blinks when CAN frames are received	Blinks quickly: Boot state Blinks very slowly (~0.5Hz): update in progress
3: Boot Mode (yellow)	OFF	ON
4: RS485 communication (green)	Blinks when a Modbus response is received	Blinks quickly: Boot state Blinks very slowly (~0.5Hz): update in progress

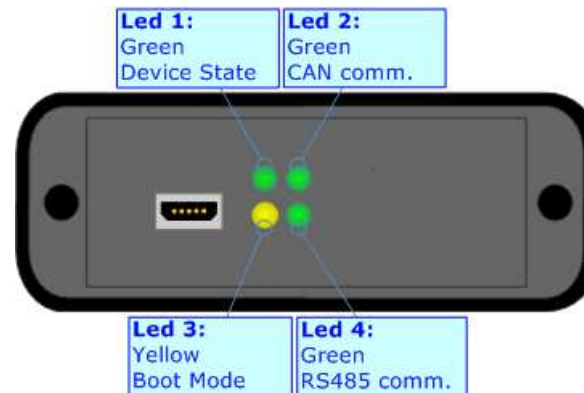

RS485:

The connection of the RS485 in the HD67411-E4x-xxx device must be made with a 3way MiniFit Female connector. The pinout of Male MiniFit connector of the board is at right side of the page.

The connection of the RS485 in the HD67411-E7x-xxx device must be made with a AMP SuperSeal 1.5 Male connector. The pinout of Female connector of the board is at right side of the page.

The termination of RS485 line, with a 220Ω resistor, in the HD67411-Exx-xxx is made internally of the device; when the order is performed. If the device have the RS485 terminated the code is the follow: HD67411-Exx-xYx; otherwise is this other: HD67411-Exx-xNx.

The maximum length of the cable should be 1200m (4000 feet).

Here some codes of cables:

- Belden: p/n 8132 - 2x 28AWG stranded twisted pairs conductor + foil shield + braid shield;
- Belden p/n 82842 - 2x 24AWG stranded twisted pairs conductor + foil shield + braid shield;
- Tasker: p/n C521 - 1x 24AWG twisted pair conductor + foil shield + braid shield;
- Tasker: p/n C522 - 2x 24AWG twisted pairs conductor + foil shield + braid shield.

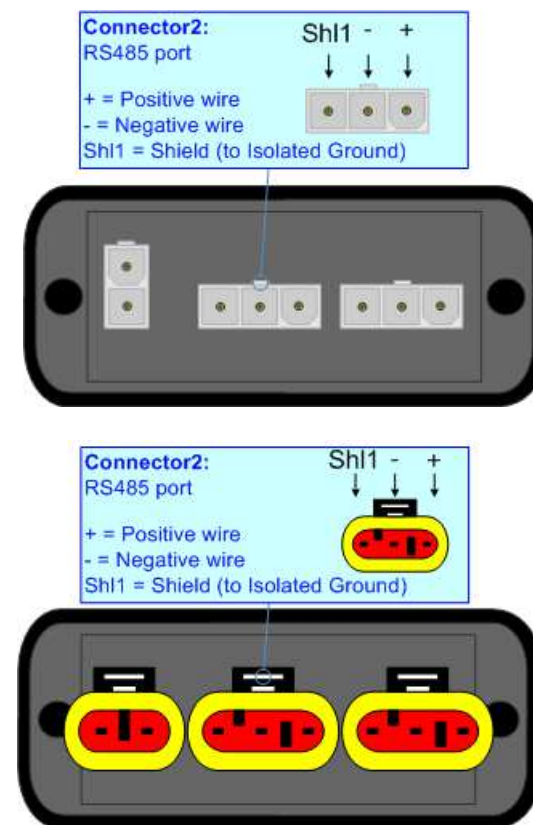

Link for Mini-Fit® connectors: http://www.molex.com/molex/products/group?key=minifit_products&channel=products

Link for SuperSeal 1.5 connectors: <http://www.te.com/catalog/cinf/en/c/10876/956>

CAN:

The connection of the CAN in the HD67411-E4x-xxx device must be made with a 3way MiniFit Female connector. The pinout of Male MiniFit connector of the board is at right side of the page.

The connection of the CAN in the HD67411-E7x-xxx device must be made with a AMP SuperSeal 1.5 Male connector. The pinout of Female connector of the board is at right side of the page.

The termination of CAN line, with a 120Ω resistor, in the HD67411-Exx-xxx is made internally of the device; when the order is performed. If the device have the CAN terminated the code is the follow: HD67411-Exx-Yxx; otherwise is this other: HD67411-Exx-Nxx.

Cable characteristics:

DC parameter:	Impedance	70 Ohm/m
AC parameters:	Impedance	120 Ohm/m
	Delay	5 ns/m
Length	Baud Rate [bps]	Length MAX [m]
	10 K	5000
	20 K	2500
	50 K	1000
	100 K	650
	125 K	500
	250 K	250
	500 K	100
	800 K	50
	1000 K	25

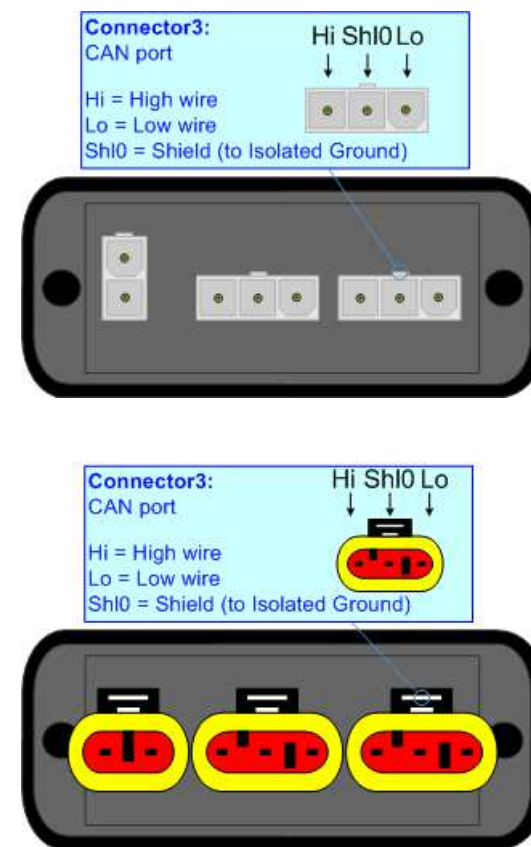

USB:

The USB port is used to start the converter in Boot Mode and to program the converter. It is necessary to use a Micro USB type B cable.

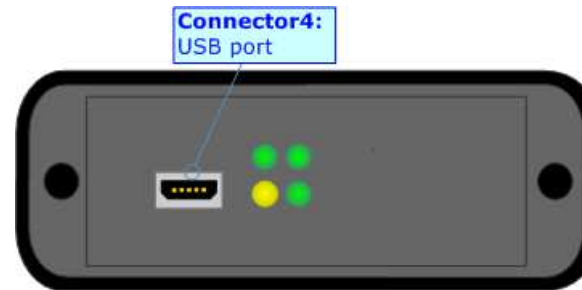

USE OF COMPOSITOR SW67411:

To configure the Converter, use the available software that runs with Windows called SW67411. It is downloadable on the site www.adfweb.com and its operation is described in this document. *(This manual is referenced to the last version of the software present on our web site).* The software works with MSWindows (XP, Vista, Seven, 8, 10; 32/64bit).

When launching the SW67411, the window below appears (Fig. 2).

 **Note:**
It is necessary to have installed .Net Framework 4.

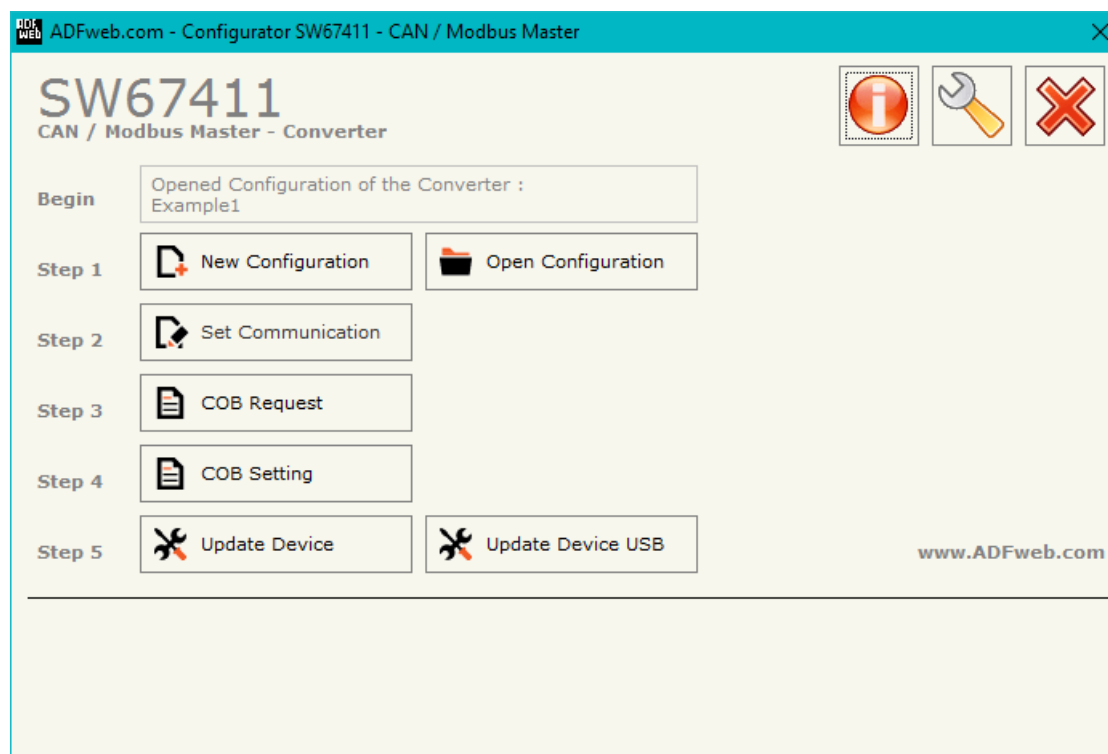
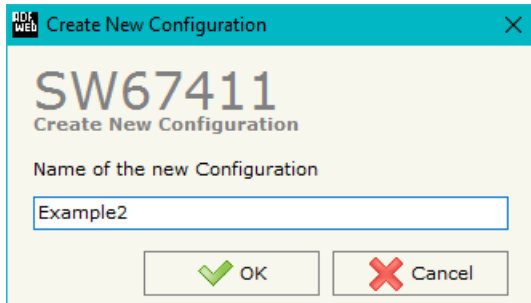

Figure 2: Main window for SW67411

NEW CONFIGURATION / OPEN CONFIGURATION:

The “**New Configuration**” button creates the folder which contains the entire device’s configuration.



A device’s configuration can also be imported or exported:

- To clone the configurations of a programmable “CAN / Modbus Master - Converter” in order to configure another device in the same manner, it is necessary to maintain the folder and all its contents;
- To clone a project in order to obtain a different version of the project, it is sufficient to duplicate the project folder with another name and open the new folder with the button “**Open Configuration**”.

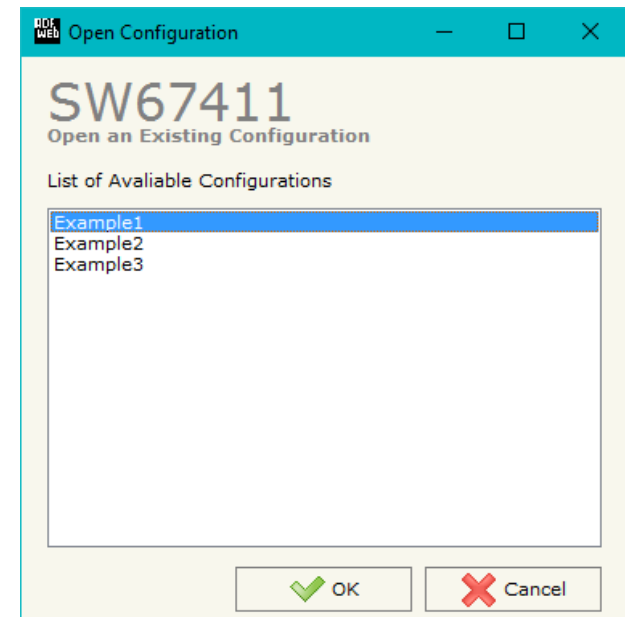

SOFTWARE OPTIONS:

By pressing the “**Settings**” () button there is the possibility to change the language of the software and check the updatings for the compositor.

In the section “Language” it is possible to change the language of the software.

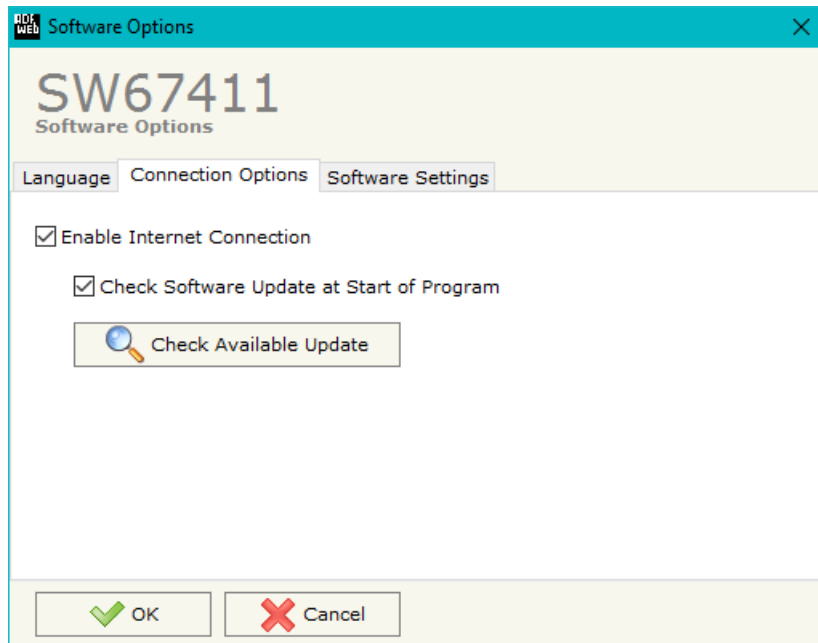

In the section “Connection Options”, it is possible to check if there are some updatings of the software compositor in ADFweb.com website. Checking the option “**Check Software Update at Start of Program**”, the SW67411 checks automatically if there are updatings when it is launched.

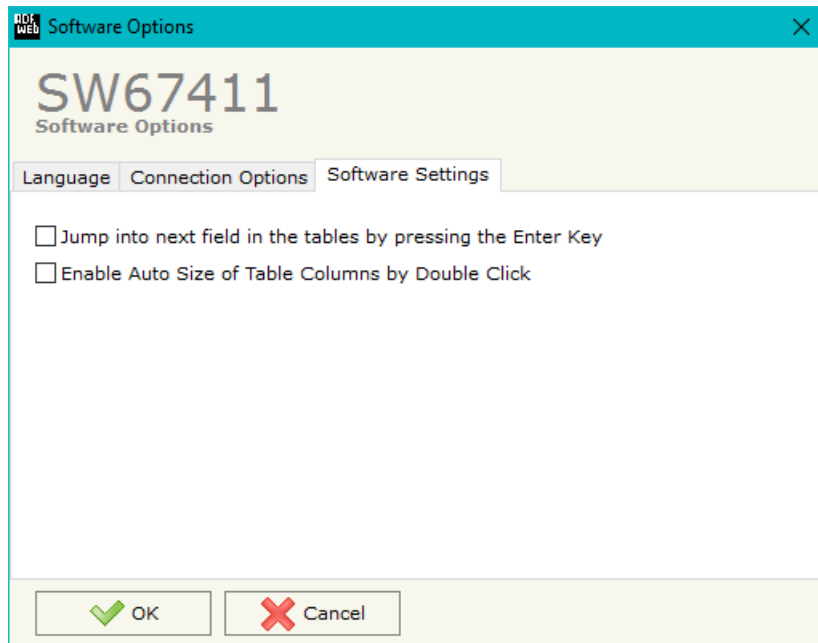

In the section "Software Settings", it is possible to enable/disable some keyboard's commands for an easier navigation inside the tables contained in the different sections of the software.

SET COMMUNICATION:

This section defines the fundamental communication parameters of two buses, CAN and Modbus.

By pressing the **"Set Communication"** button from the main window for SW67411 (Fig. 2) the window "Set Communication Setting" appears (Fig. 3).

The meaning of the fields of "CAN" are:

- In the field **"Baudrate"** the data rate of the CAN bus is defined;
- If the field **"Enable HeartBeat"** is checked, the device sends CAN messages to the network to confirm its presence;
- In the field **"HB Time (ms)"** the time between two HeartBeat messages (expressed in milliseconds) is defined;
- In the field **"HB CobID"** the COB-ID of the HeartBeat message is defined;
- In the field **"HB CAN Type"** the type of CAN communication for HeartBeat message is defined;
- In the field **"HB Number Bytes"** the number of byte for the HeartBeat message is defined;
- In the field **"HB Data Message (HEX)"** the data of the bytes of the HeartBeat message is defined. The bytes have to be written in Hexadecimal and separated by a space (for example to insert the byte 1,2,3 and 255 the correct string is "01 02 03 FF").

The meaning of the fields of "Modbus Master" are:

- In the field **"Baudrate"** the data rate of the RS485 bus is defined;
- In the field **"Parity"** the serial parity is defined;
- In the field **"TimeOut (ms)"** the maximum time that the device has to attend for the answer from the Slave interrogated is defined;
- In the field **"Cyclic Delay (ms)"** the delay between a Modbus request and the following is defined.

The screenshot shows a software window titled "Set Communication" for device "SW67411". It is divided into two main sections: "CAN" and "Modbus Master".

CAN Section:

- Baudrate: 125K (dropdown)
- Enable HeartBeat:
- HB Time (ms): 1000 (text input)
- HB CobID: 0x101 (text input)
- HB CAN Type: CAN 2.0A (dropdown)
- HB Number Bytes: 1 (text input)
- HB Data Message (HEX): 00 (text input)

Modbus Master Section:

- Baudrate: 115200 (dropdown)
- Parity: NONE (dropdown)
- TimeOut (ms): 1200 (text input)
- Cyclic Delay (ms): 130 (text input)

At the bottom right, there are two buttons: "OK" (with a green checkmark icon) and "Cancel" (with a red X icon).

Figure 3: "Set Communication" window

COB REQUEST:

By pressing the “**COB Request**” button from the main window for SW67411 (Fig. 2) the window “Define CAN frame for a Modbus Read Request” appears (Fig. 4). In this section, it is possible to define the CAN frames that the converter will receive from CAN network.

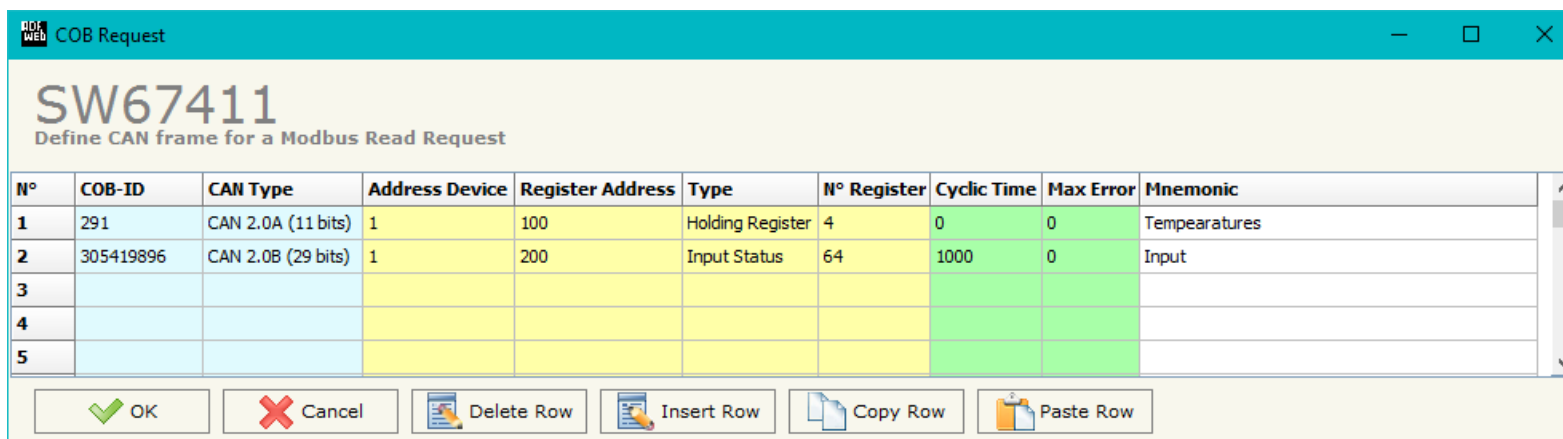

Figure 4: “Define CAN frame for a Modbus Read Request” window

These are the meanings of the various fields that composes the table:

- In the field “**Cob-ID**” the COB-ID of the CAN frame is defined;
- In the field “**CAN Type**” the type of the CAN protocol used for each frame (CAN 2.0A (11 bits) or CAN 2.0B (29 bits)) is defined;
- In the field “**Address Device**” the ID of the Modbus slave to read is defined;
- In the field “**Register Address**” the Modbus register to read is defined;
- In the field “**Type**” the type of Modbus register that you would like to read is defined;
- In the field “**N° Register**” the number of consecutive Modbus registers to read is defined;
- In the field “**Cyclic Time**” the delay between two Modbus requests is defined;
- In the field “**Max Error**” the number of consecutive errors that the Master waits before discarding the row from the cycle of requests is defined;
- In the field “**Mnemonic**” a description of the frame is defined.

Examples:

1)
 In the first case of the table:
 if we want to read the 4 Holding Register at address 100 (Fig. 4) we must send a CAN bus frame with COB ID= 291 (0x123) and without data (Fig. 5).
 As an answer we would have a CAN bus frame with COB ID=291 (0x123) and 8 bytes of data. They are the value of the Modbus registers.

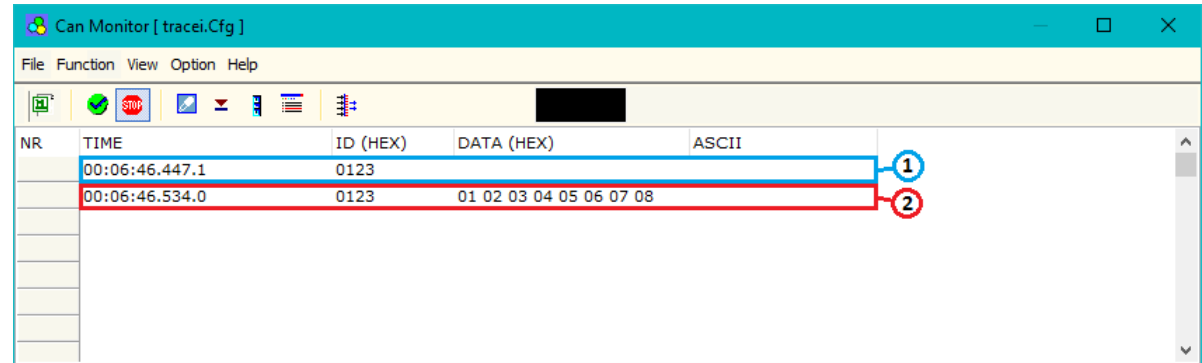

Figure 5: "Can Monitor" window to visualize the CAN frame for read request 1

2)
 In the second case of the table:
 the item has a "Cyclic Time"; so if the converter is able to require the data to the Modbus Slave and it automatically sends the frames on CAN (Fig. 6). If the Modbus Slave isn't reachable, no frames are sent on the CAN bus network.

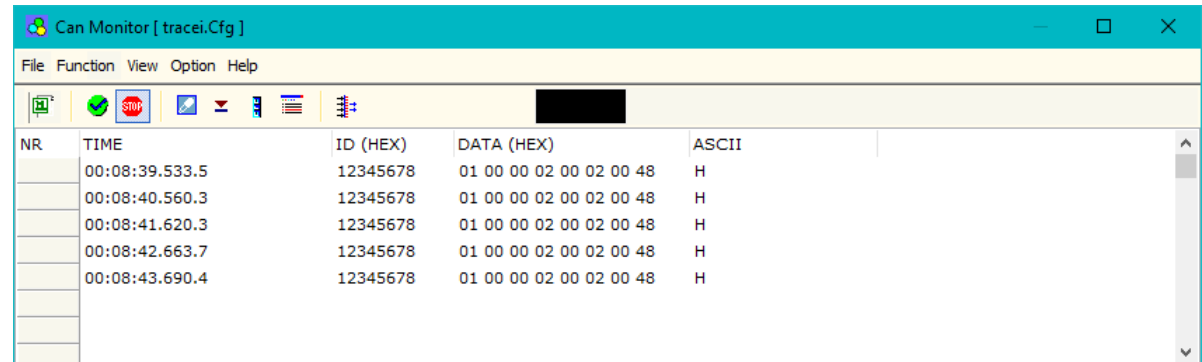

Figure 6: "Can Monitor" window to visualize the CAN frame for read request 2

COB SETTING:

By pressing the **COB Setting** button from the main window for SW67411 (Fig. 2) the window "Define CAN frame for a Modbus Write Request" appears (Fig. 7). In this section, it is possible to define the CAN frames that the converter will receive from CAN network.

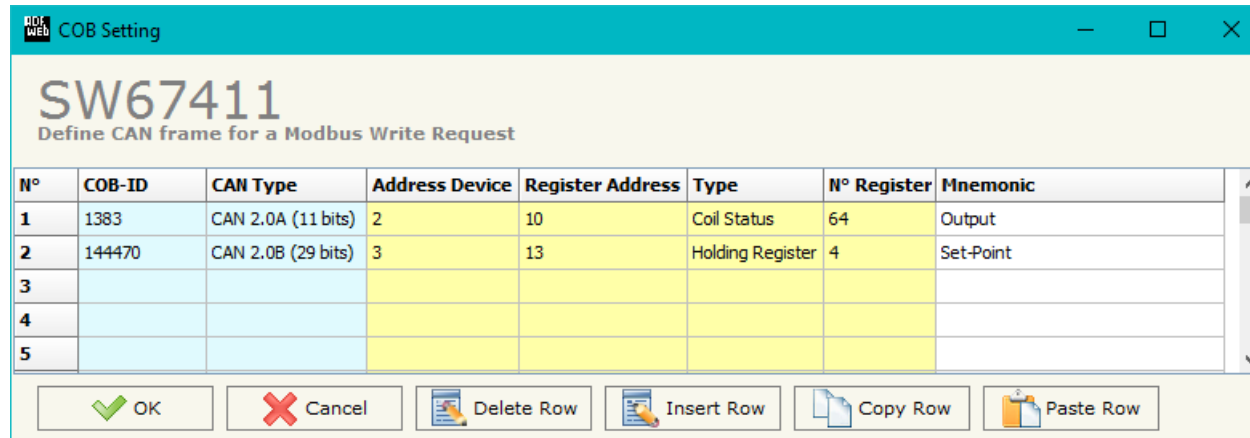

Figure 7: "Define CAN frame for a Modbus Write Request" window

These are the meanings of the various fields that composes the table:

- In the field **COB-ID** the COB-ID of the CAN frame is defined;
- In the field **Type** the type of the CAN protocol used for each frame (CAN 2.0A (11 bits) or CAN 2.0B (29 bits)) is defined;
- In the field **Address Device** the ID of the Modbus slave to write is defined;
- In the field **Register Address** the Modbus register to write is defined;
- In the field **Type** the type of Modbus register that you would like to write is defined;
- In the field **N° Register** the number of consecutive Modbus registers to write is defined;
- In the field **Mnemonic** a description of the frame is defined.

Example:

If we want to write the 64 Coil Status at address 10 (Fig. 7) we must send a CAN frame with COB ID=1383 (0x567) and 8 byte of data (Fig. 8); they are the values of the registers Modbus that they want to set.

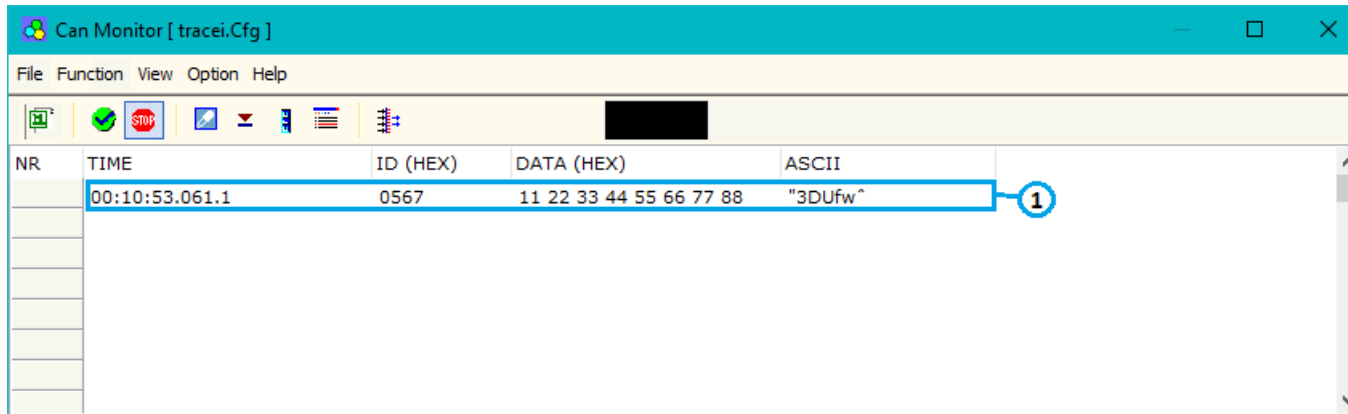

Figure 8: "Can Monitor" window to visualize the CAN frame for write request

UPDATE DEVICE (ONLY FOR THE HARDWARE WITHOUT USB PORT):

By pressing the **"Update Device"** button it is possible to load the created Configuration into the device; and also the Firmware, if is necessary.

In order to load the parameters or update the firmware in the Converter, follow these instructions:

- Connect the AC67400 to the PC;
- Connect the CAN port of AC67400 to CAN port of HD67411;
- Feed the HD67411;
- Turn on the device;
- Select the **"COM port"** and press the **"Connect"** button;
- Press the **"Next"** button;
- Select which operations you want to do.
- Press the **"Execute update firmware"** button to start the upload;
- When all the operations are "OK" turn OFF the device;
- Disconnect the AC67400;
- Turn on the device.

At this point the configuration/firmware on the device is correctly update.

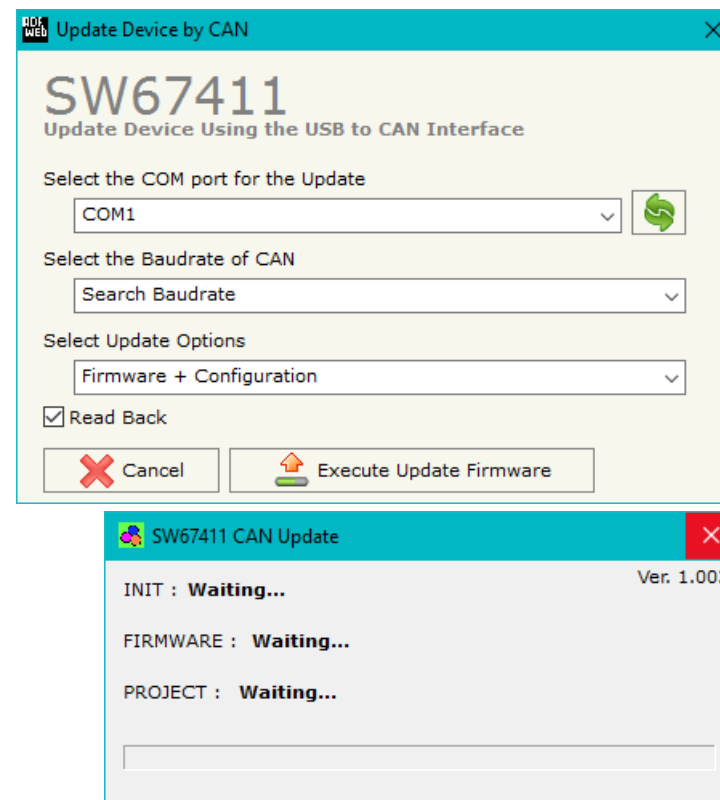

Figure 9: "Update Device" windows

UPDATE DEVICE USB:

By pressing the **“Update Device USB”** button it is possible to load the created Configuration into the device, and also the Firmware if is necessary, using the USB port.

In order to load the parameters or update the firmware in the device, follow these instructions:

- Connect the USB cable from your PC to the Converter;
- Select the **“COM port”**;
- Select which operations you want to do.
- Press the **“Execute update firmware”** button to start the upload;
- When all the operations are **“OK”**, disconnect the USB cable;

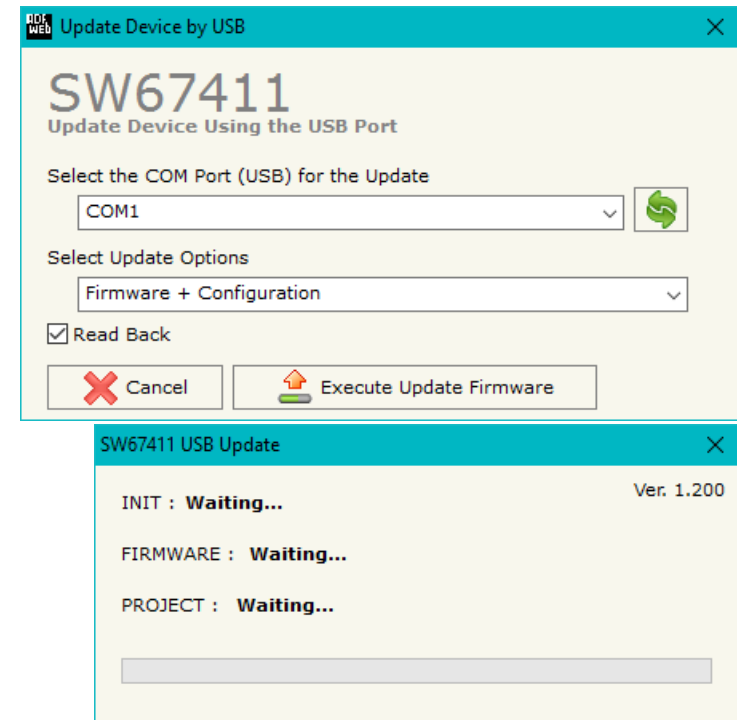





Figure 10: “Update Device” windows

 **Note:**
When you install a new version of the software it is better if the first time you do the update of the Firmware in the HD67411 device.

 **Note:**
When you receive the device, for the first time, you have to update also the Firmware in the HD67411 device.

 **Warning:**
If the Fig. 11 appears when you try to do the Update before require assistance try these points:

- Check if the serial COM port selected is the correct one;
- Check if the AC67400 is connected between the PC and the device;
- Check if the USB cable is connected between the PC and the device;
- Try to repeat the operations for the updating;
- Try with another PC;
- Try to restart the PC;
- If you are using the program inside a Virtual Machine, try to use in the main Operating System;
- If you are using Windows Seven or Vista or 8 or 10, make sure that you have the administrator privileges;
- Pay attention to Firewall lock.

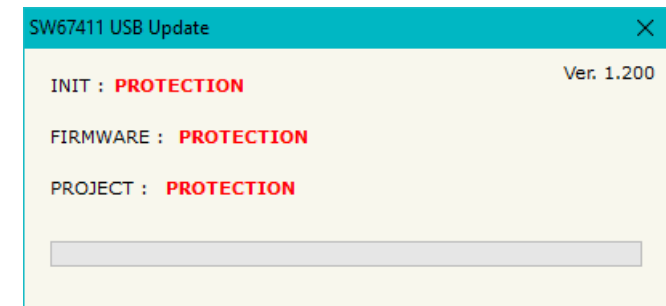
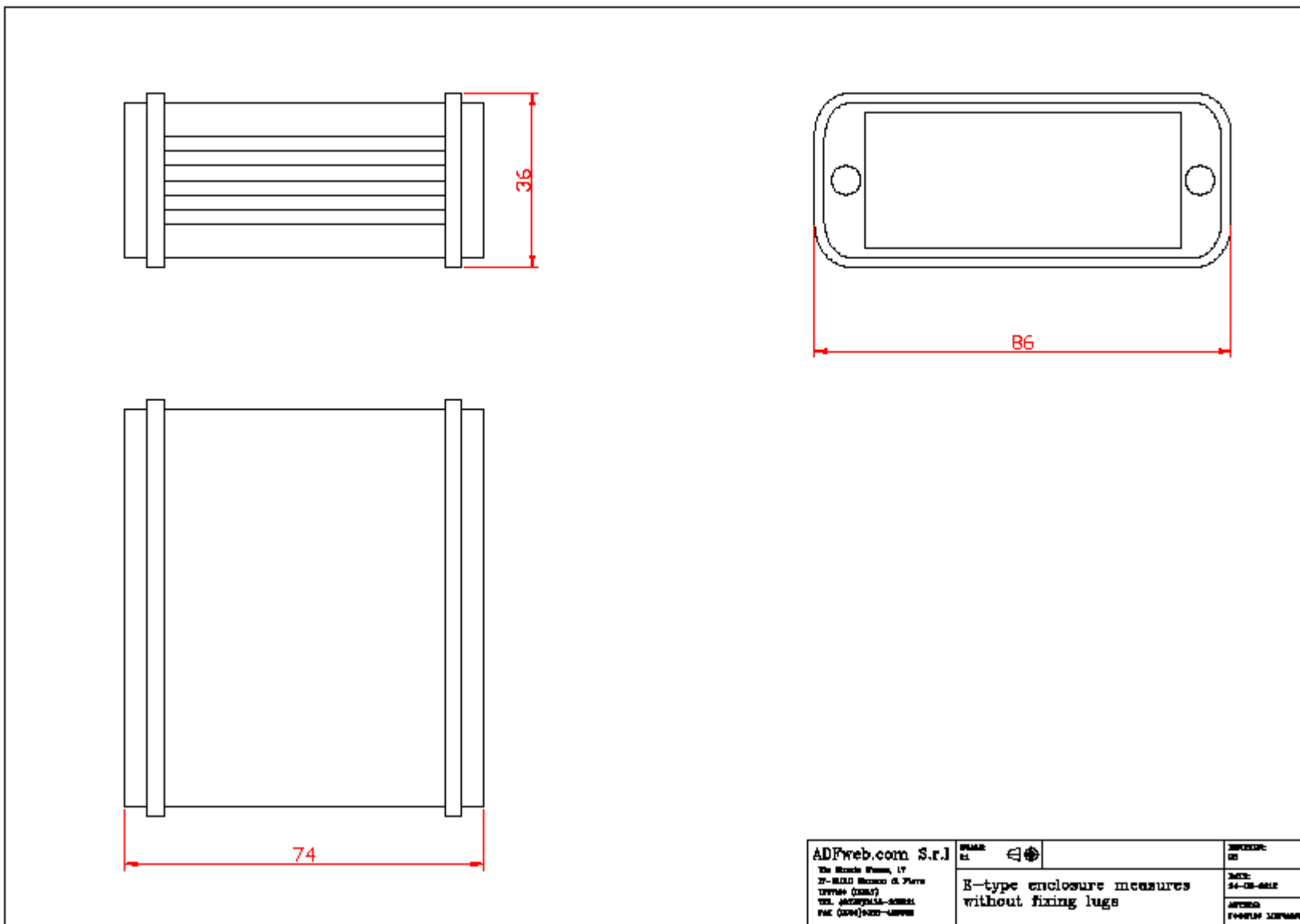
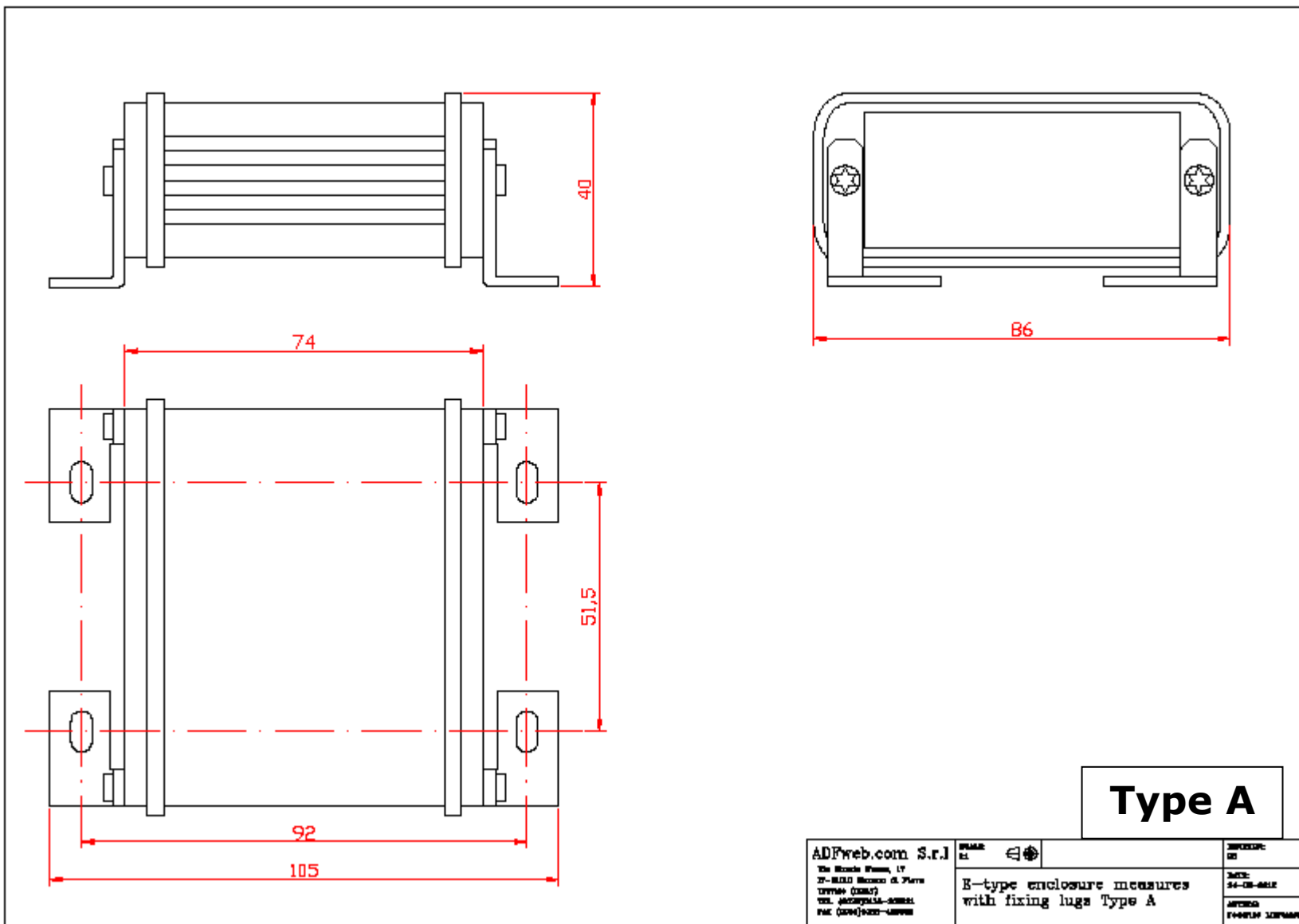

Figure 11: "Protection" window

MECHANICAL DIMENSIONS:



<p>ADFweb.com S.r.l. Via Monte Rosso, 17 37-04010 MARENO di PIAVE TREVISO (TV) 31047 TEL. (0423)544-5444 FAX (0423)544-5444</p>	<p>IPRAME E2</p>	<p>E-type enclosure measures without fixing lugs</p>	<p>INDICAZIONE DEI MATERIE 54-08-0812 AUTORE FABRILIA LOMBARDO</p>
---	----------------------	--	--



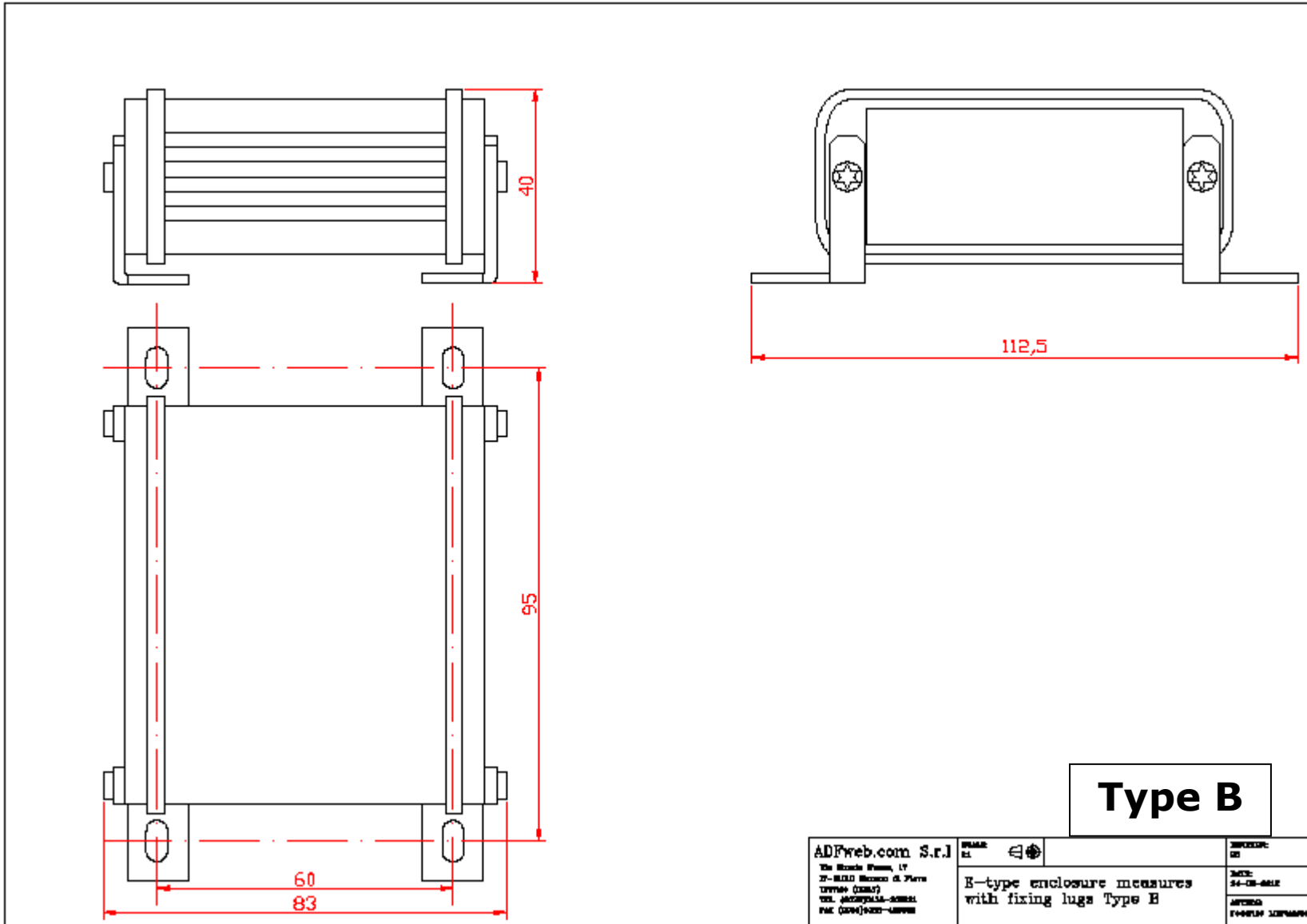

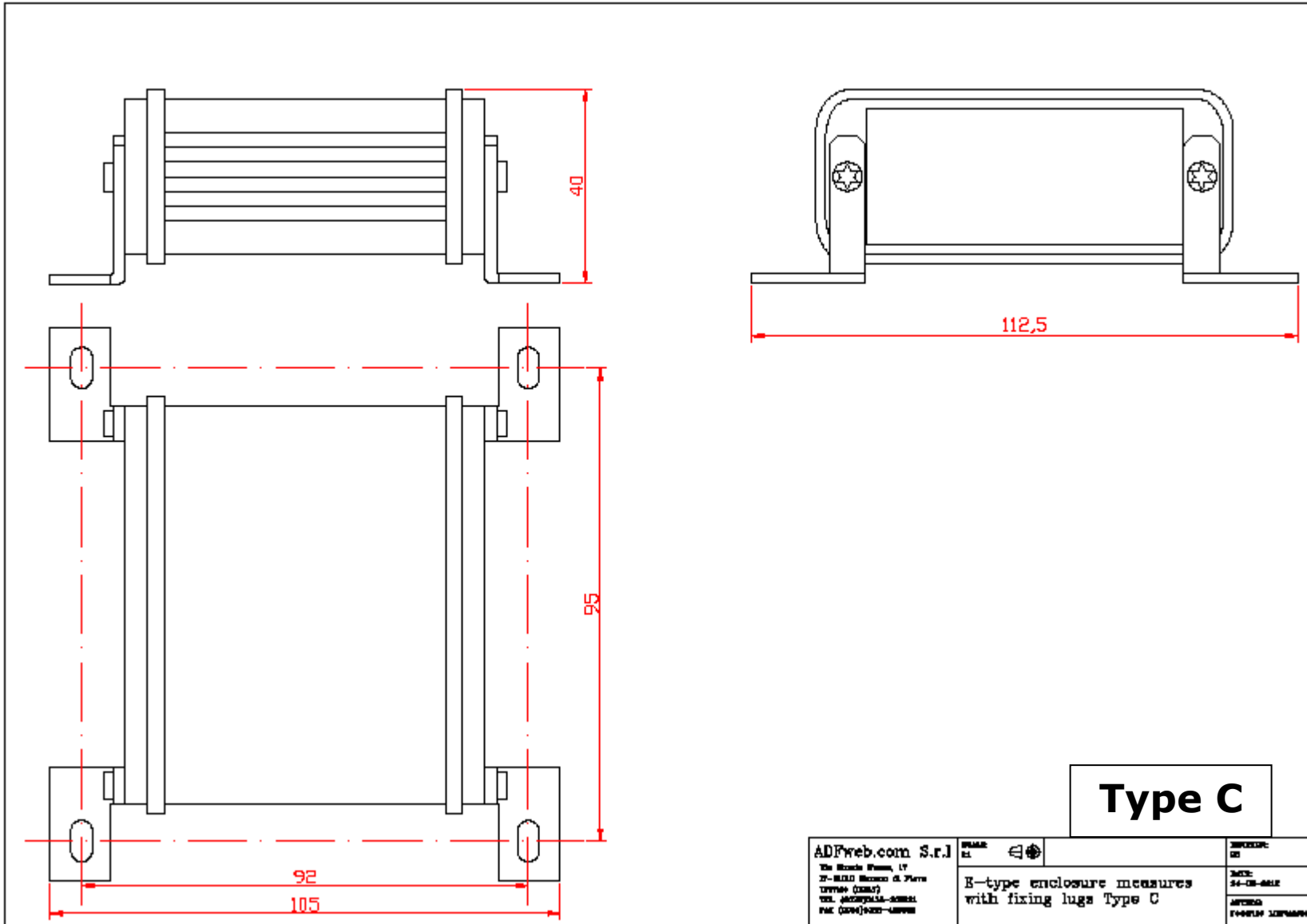

ORDERING INFORMATIONS:

The ordering part number is formed by a valid combination of the following:

HD67411 - E y z - s d f

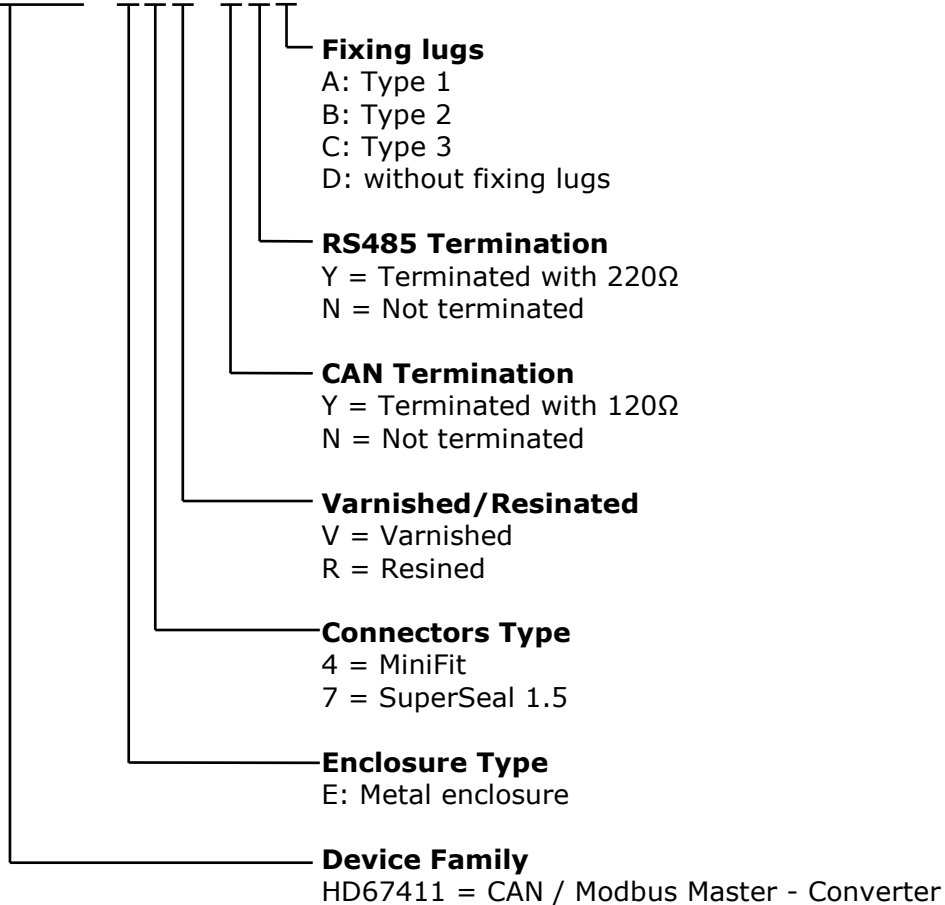

ACCESSORIES:

- Order Code: **AC34001** - Rail DIN - Power Supply 220/240V AC 50/60Hz – 12 V AC
- Order Code: **AC34002** - Rail DIN - Power Supply 110V AC 50/60Hz – 12 V AC
- Order Code: **AC67402** - Cable Super Seal 1.5 MALE 2-pole - 1.0 Meter
- Order Code: **AC67402-3** - Cable Super Seal 1.5 MALE 2-pole - 3.0 Meters
- Order Code: **AC67403** - Cable Super Seal 1.5 MALE 3-pole - 1.0 Meter
- Order Code: **AC67403-3** - Cable Super Seal 1.5 MALE 3-pole - 3.0 Meters
- Order Code: **AC67410** - Accessory Automotive Devices - Support for rail DIN

DISCLAIMER:

All technical content within this document can be modified without notice. The content of the document is a under continual renewal. For losses due to fire, earthquake, third party access or other accidents, or intentional or accidental abuse, misuse, or use under abnormal conditions repairs are charged to the user. ADFweb.com S.r.l. will not be liable for accidental loss of use or inability to use this product, such as loss of business income. ADFweb.com S.r.l. shall not be liable for consequences of improper use.

OTHER REGULATIONS AND STANDARDS:**WEEE INFORMATION**

Disposal of old electrical and electronic equipment (as in the European Union and other European countries with separate collection systems).

— This symbol on the product or on its packaging indicates that this product may not be treated as household rubbish. Instead, it should be taken to an applicable collection point for the recycling of electrical and electronic equipment. If the product is disposed correctly, you will help prevent potential negative environmental factors and impact of human health, which could otherwise be caused by inappropriate disposal. The recycling of materials will help to conserve natural resources. For more information about recycling this product, please contact your local city office, your household waste disposal service or the shop where you purchased the product.

RESTRICTION OF HAZARDOUS SUBSTANCES DIRECTIVE

The device respects the 2002/95/EC Directive on the restriction of the use of certain hazardous substances in electrical and electronic equipment (commonly referred to as Restriction of Hazardous Substances Directive or RoHS).

CE MARKING

The product conforms with the essential requirements of the applicable EC directives.

WARRANTIES AND TECHNICAL SUPPORT:

For fast and easy technical support for your ADFweb.com SRL products, consult our internet support at www.adfweb.com. Otherwise contact us at the address support@adfweb.com

RETURN POLICY:

If while using your product you have any problem and you wish to exchange or repair it, please do the following:

- Obtain a Product Return Number (PRN) from our internet support at www.adfweb.com. Together with the request, you need to provide detailed information about the problem.
- Send the product to the address provided with the PRN, having prepaid the shipping costs (shipment costs billed to us will not be accepted).

If the product is within the warranty of twelve months, it will be repaired or exchanged and returned within three weeks. If the product is no longer under warranty, you will receive a repair estimate.



ADFweb.com S.r.l.
Via Strada Nuova, 17
IT-31010 Mareno di Piave
TREVISO (Italy)
Phone +39.0438.30.91.31
Fax +39.0438.49.20.99
www.adfweb.com

