

User Manual

Revision 1.000

English

EtherNet/IP / CAN – Converter

(Order Code: HD67419)

For Website information:

www.adfweb.com?Product=HD67419

For Price information:

www.adfweb.com?Price=HD67419

Benefits and Main Features:

- ✦ Very easy to configure
- ✦ Wide supply input range
- ✦ Electrical isolation
- ✦ Industrial temperature range:
- ✦ -40°C / 105°C (-40°F / 221°F)



For others Gateways / Bridges:

J1939 to Modbus

See also the following links:

www.adfweb.com?Product=HD67212 (Modbus RTU)

CANopen to Modbus

See also the following links:

www.adfweb.com?Product=HD67001 (Modbus RTU Master)

www.adfweb.com?Product=HD67002 (Modbus RTU Slave)

www.adfweb.com?Product=HD67004 (Modbus TCP Master)

www.adfweb.com?Product=HD67005 (Modbus TCP Slave)

For others Gateways / Bridges:

For **CAN bus 2.0A** and/or **CAN bus 2.0B to Modbus**

See also the following links:

www.adfweb.com?Product=HD67011 (Modbus RTU Slave)

www.adfweb.com?Product=HD67012 (Modbus RTU Master)

www.adfweb.com?Product=HD67014 (Modbus TCP Slave)

www.adfweb.com?Product=HD67015 (Modbus TCP Master)

Do you have an your customer protocol?

See the following links:

www.adfweb.com?Product=HD67003

Do you need to choose a device? do you want help?

Ask it to the following link:

www.adfweb.com?Cmd=helpme



User Manual

INDEX:

	Page
INDEX	2
UPDATED DOCUMENTATION	2
REVISION LIST	2
WARNING	2
TRADEMARKS	2
SECURITY ALERT	3
EXAMPLES OF CONNECTION	4
CONNECTION SCHEME	5
CHARACTERISTICS	7
CONFIGURATION	7
POWER SUPPLY	8
LEDS	9
CAN	10
ETHERNET	11
USB	11
USE OF COMPOSITOR SW67419	12
NEW PROJECT / OPEN PROJECT	13
SOFTWARE OPTIONS	14
SET COMMUNICATION	16
RECEIVE FRAMES	17
INFO RECEIVE	18
SEND FRAMES	19
INFO SEND	20
UPDATE DEVICE	21
MECHANICAL DIMENSIONS	23
ORDER CODE	27
ACCESSORIES	28
PLC CONFIGURATION	29
DISCLAIMER	33
OTHER REGULATIONS AND STANDARDS	33
WARRANTIES AND TECHNICAL SUPPORT	34
RETURN POLICY	34

UPDATED DOCUMENTATION:

Dear customer, we thank you for your attention and we remind you that you need to check that the following document is:

- Updated
- Related to the product you own

To obtain the most recently updated document, note the “document code” that appears at the top right-hand corner of each page of this document.

With this “Document Code” go to web page www.adfweb.com/download/ and search for the corresponding code on the page. Click on the proper “Document Code” and download the updates.

REVISION LIST:

Revision	Date	Author	Chapter	Description
1.000	15/06/2017	Ff	All	First released version

WARNING:

ADFweb.com reserves the right to change information in this manual about our product without warning.
ADFweb.com is not responsible for any error this manual may contain.

TRADEMARKS:

All trademarks mentioned in this document belong to their respective owners.

SECURITY ALERT:**GENERAL INFORMATION**

To ensure safe operation, the device must be operated according to the instructions in the manual. When using the device, legal and safety regulation are required for each individual application. The same applies also when using accessories.

INTENDED USE

Machines and systems must be designed so the faulty conditions do not lead to a dangerous situation for the operator (i.e. independent limit switches, mechanical interlocks, etc.).

QUALIFIED PERSONNEL

The device can be used only by qualified personnel, strictly in accordance with the specifications. Qualified personnel are persons who are familiar with the installation, assembly, commissioning and operation of this equipment and who have appropriate qualifications for their job.

RESIDUAL RISKS

The device is state-of-the-art and is safe. The instruments can represent a potential hazard if they are inappropriately installed and operated by untrained personnel. These instructions refer to residual risks with the following symbol:



This symbol indicates that non-observance of the safety instructions is a danger for people that could lead to serious injury or death and / or the possibility of damage.

CE CONFORMITY

The declaration is made by our company. You can send an email to support@adfweb.com or give us a call if you need it.

EXAMPLE OF CONNECTION:

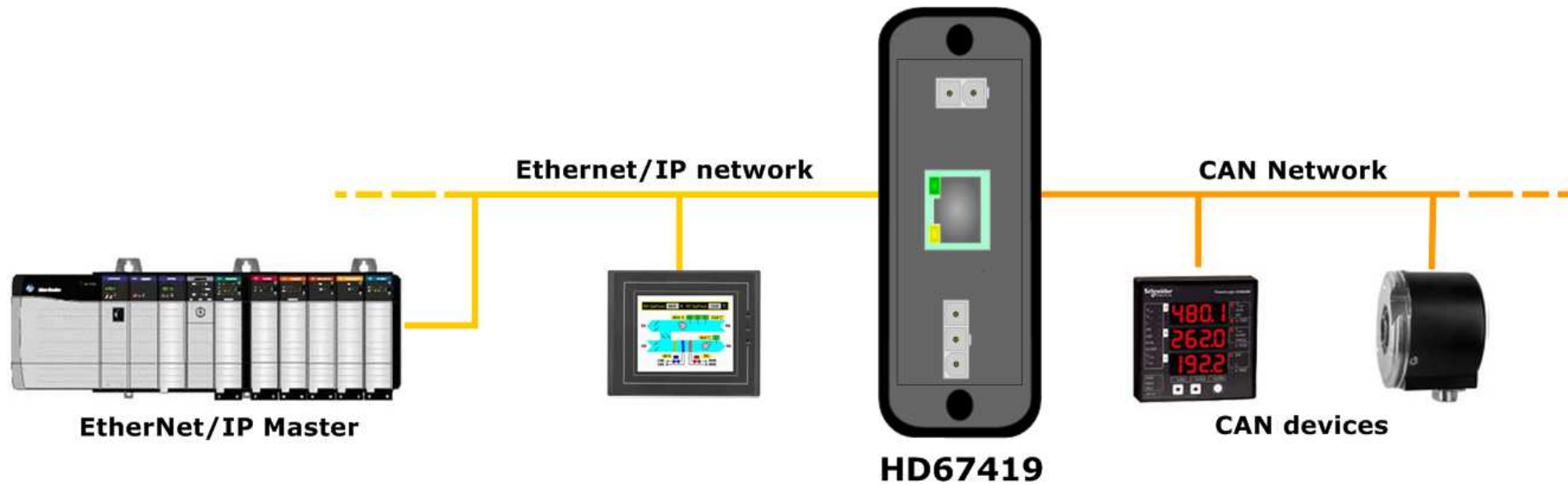

CONNECTION SCHEME:

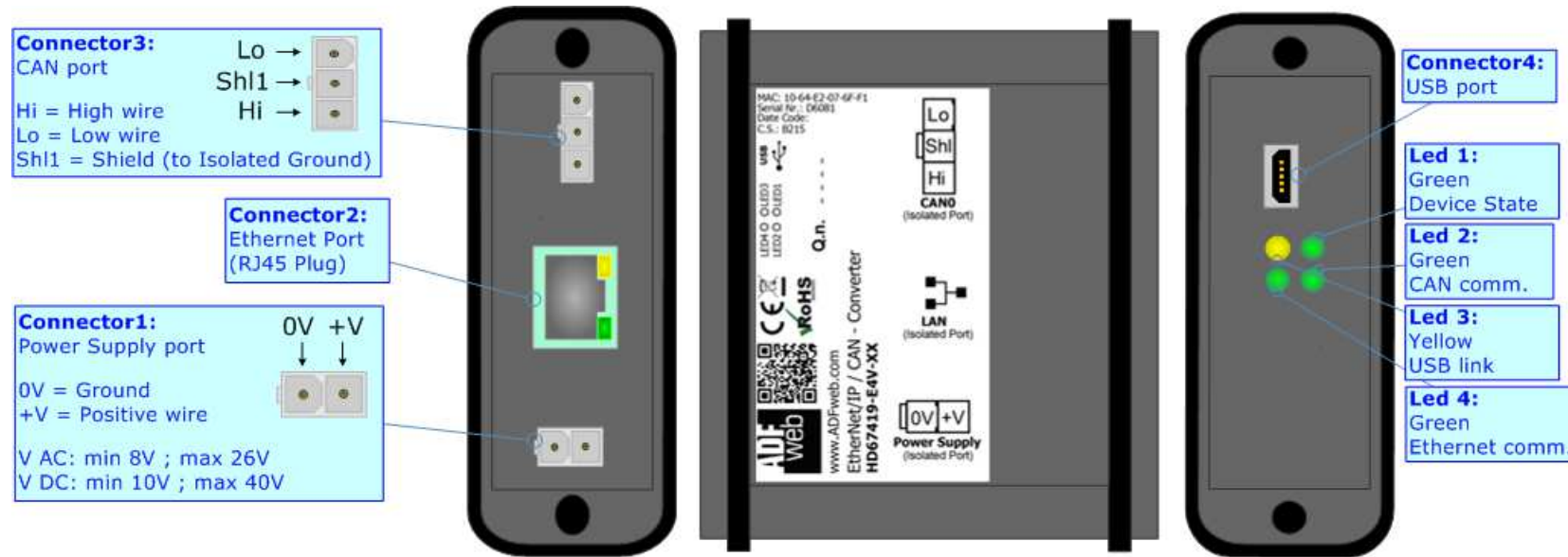

Figure 1a: Connection scheme for HD67419-E4x-xx

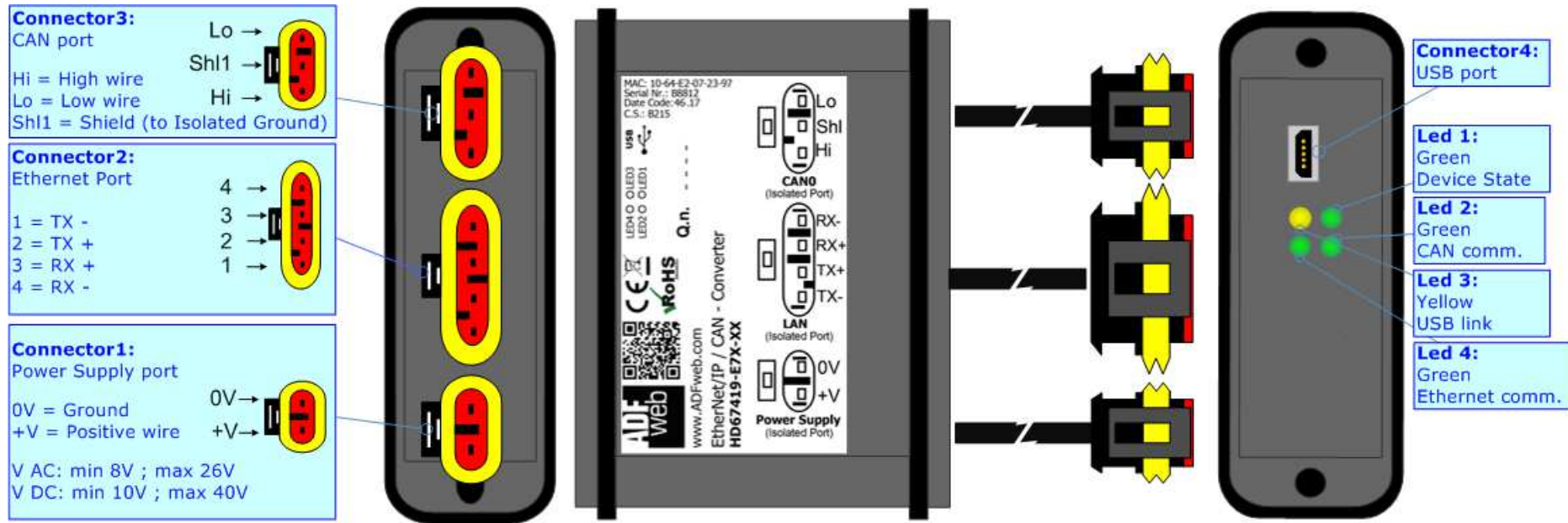

Figure 1b: Connection scheme for HD67419-E7x-xx

CHARACTERISTICS:

The "HD67419" series are rugged devices used to interface CAN devices with EtherNet/IP network.

With its particular enclosure, equipped with four fixing lugs, makes available the mounting of the device in any plane surface (horizontal, vertical, oblique).

It is possible to have the device varnished or totally resined and also in both cases with "Mini-Fit®" connectors or "AMP SuperSeal 1.5" connectors. If is resined, the enclosure, like the "AMP SuperSeal 1.5" connectors, is waterproof.

All the four series have these characteristics:

- Triple 4kV isolation between Power Supply / EtherNet/IP / CAN;
- Varnished / Resined (optionally);
- Wide power supply input range: 8...26V AC | 10...40V DC;
- Mini-Fit® / AMP SuperSeal 1.5 connectors;
- Metal enclosure with fixing lugs;
- Possibility to use Metal hose clamps for fixing it without using lugs;
- Microprocessor for data control;
- Wide temperature range: -40°C / 105°C (-40°F / 221°F).

CONFIGURATION:

You need Compositor SW67419 software on your PC in order to perform the following:

- Define the parameter of Ethernet/IP line;
- Define the parameter of CAN line;
- Determinate which Ethernet/IP byte transfer in CAN and vice versa;
- Update the device.

POWER SUPPLY:

The devices can be powered between a wide range of tensions. For more details see the two tables below.

	VAC		VDC	
	Vmin	Vmax	Vmin	Vmax
HD67419-Exx-xx	8V	26V	10V	40V

Consumption at 24V DC:

Device	W/VA
HD67419-Exx-xx	4

Caution: Not reverse the polarity power

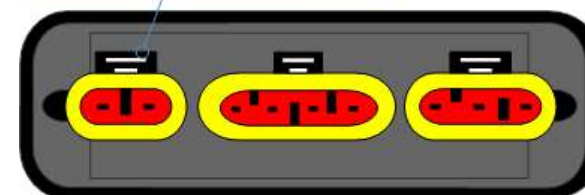
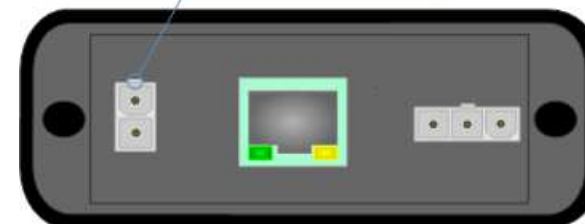
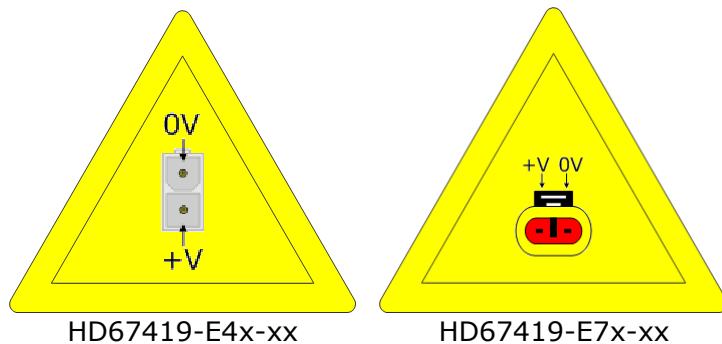

Note: It is possible to use also negative tensions. In this case the polarity must be inverted.

LEDS:

The device has got four LEDs that are used to give information of the functioning status. The various meanings of the LEDs are described in the table below.

LED	Normal Mode	Boot Mode
1: Device state (green)	Blinks slowly (~1Hz)	Blinks quickly: Boot state Blinks very slowly (~0.5Hz): update in progress
2: CAN Communication (green)	Blinks when CAN frames are received	Blinks quickly: Boot state Blinks very slowly (~0.5Hz): update in progress
3: USB link (yellow)	ON: USB cable inserted OFF: USB cable not inserted	ON: USB cable inserted OFF: USB cable not inserted
4: Ethernet communication (green)	Blinks when EtherNet/IP communication is working	Blinks quickly: Boot state Blinks very slowly (~0.5Hz): update in progress

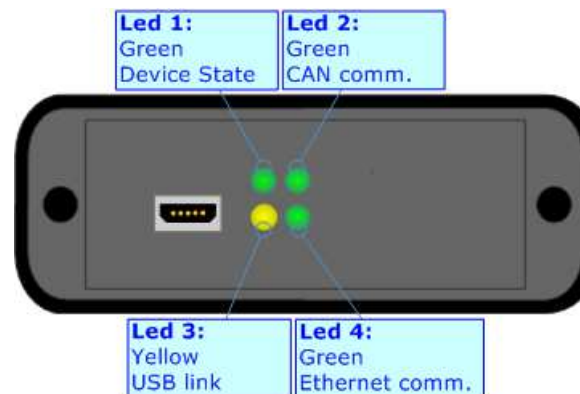

CAN:

The connection of CAN in the HD67419-E4x-xx device must be made with a 3way MiniFit Female connector. The pinout of Male Mini-Fit connector of the board is at right side of the page.

The connection of CAN in the HD67419-E7x-xx device must be made with a AMP SuperSeal 1.5 Male connector. The pinout of Female connector of the board is at right side of the page.

The termination of CAN line, with a 120Ω resistor, in the HD67419-Exx-xx is made internally of the device; when the order is performed. If the device have the CAN terminated the code is the follow: HD67419-Exx-Yx; otherwise is this other: HD67419-Exx-Nx.

Cable characteristics:

DC parameter:	Impedance	70 Ohm/m
AC parameters:	Impedance	120 Ohm/m
	Delay	5 ns/m
Length	Baud Rate [bps]	Length MAX [m]
	10 K	5000
	20 K	2500
	50 K	1000
	100 K	650
	125 K	500
	250 K	250
	500 K	100
	800 K	50
	1000 K	25

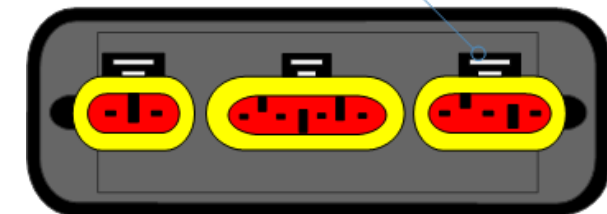
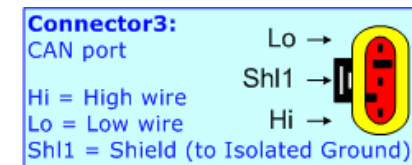
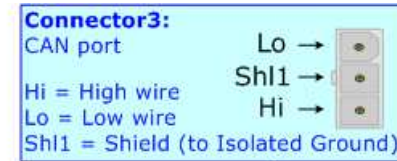

ETHERNET:

The connection of Ethernet in the HD67419 device must be made with at least a Category 5E cable. The maximum length of the cable should not exceed 100m. The cable has to conform to the T568 norms relative to connections in cat.5 up to 100 Mbps. To connect the device to an Hub/Switch is recommended the use of a straight cable, to connect the device to a PC/PLC/other is recommended the use of a cross cable.

The connection of Ethernet in the HD67419-E4x-xx device must be made with RJ45 connector.

The connection of the Ethernet in the HD67419-E7x-xx device must be made with a AMP SuperSeal 1.5 Male connector. The pinout of Female connector of the board is at right side of the page.

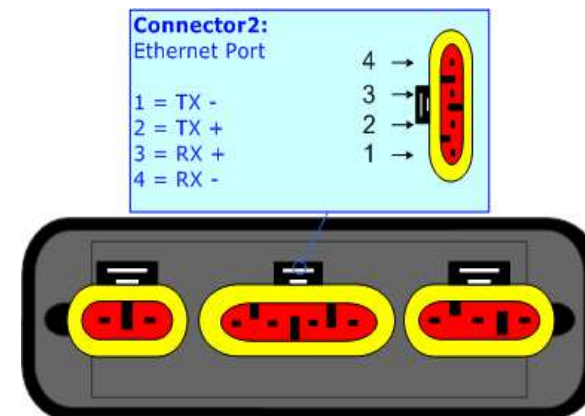

USB:

The USB port is used to start the converter in Boot Mode. It is necessary to use a Micro USB type B cable.

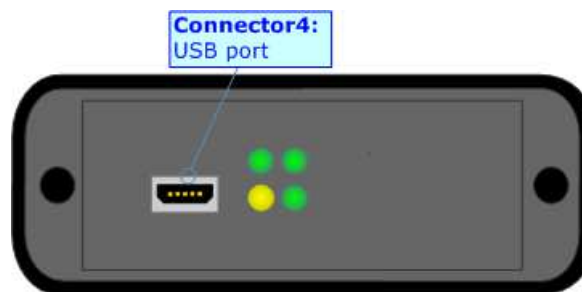

USE OF COMPOSITOR SW67419:

To configure the Converter, use the available software that runs with Windows called SW67419. It is downloadable on the site www.adfweb.com and its operation is described in this document. (*This manual is referenced to the last version of the software present on our web site*). The software works with MSWindows (XP, Vista, Seven, 8, 10; 32/64bit).

When launching the SW67419, the window below appears (Fig. 2).



Note:

It is necessary to have installed .Net Framework 4.

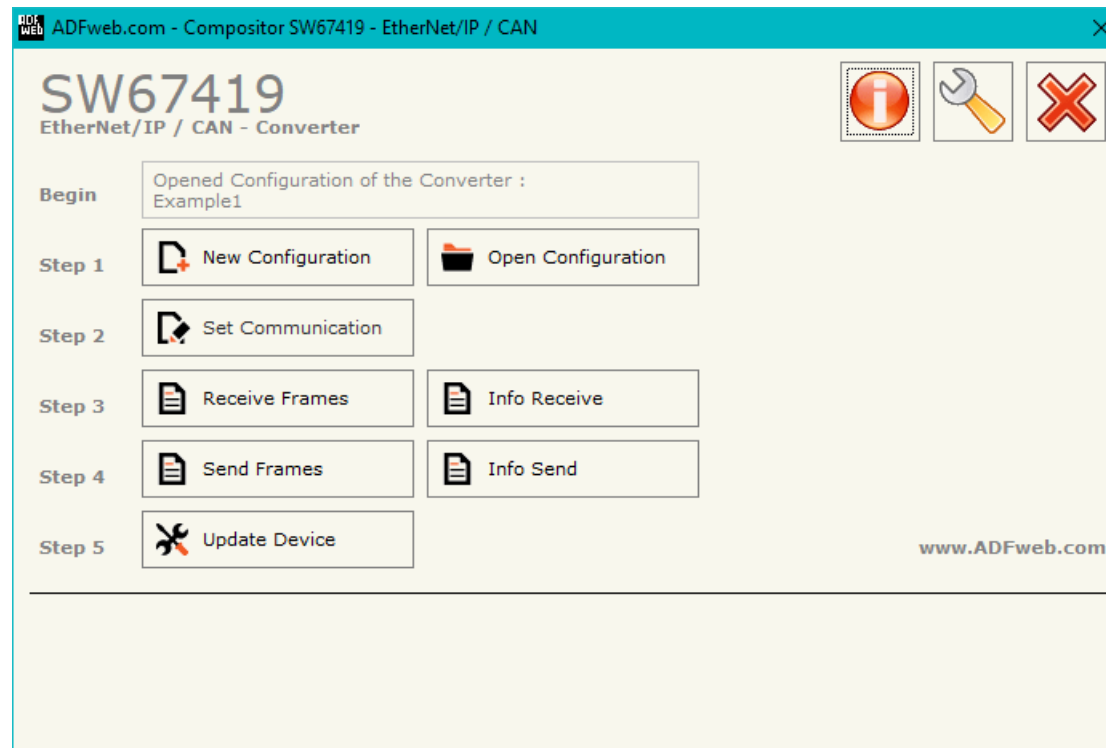
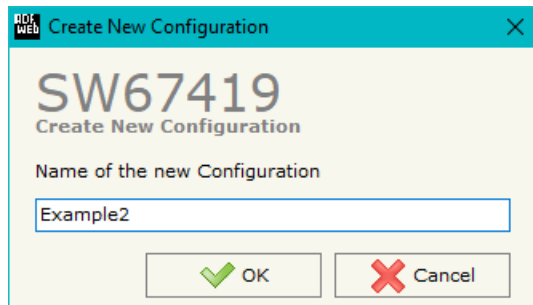

Figure 2: Main window for SW67419

NEW CONFIGURATION / OPEN CONFIGURATION:

The “**New Configuration**” button creates the folder which contains the entire device’s configuration.



A device’s configuration can also be imported or exported:

- To clone the configurations of a programmable “EtherNet/IP / CAN - Converter” in order to configure another device in the same manner, it is necessary to maintain the folder and all its contents;
- To clone a project in order to obtain a different version of the project, it is sufficient to duplicate the project folder with another name and open the new folder with the button “**Open Configuration**”.

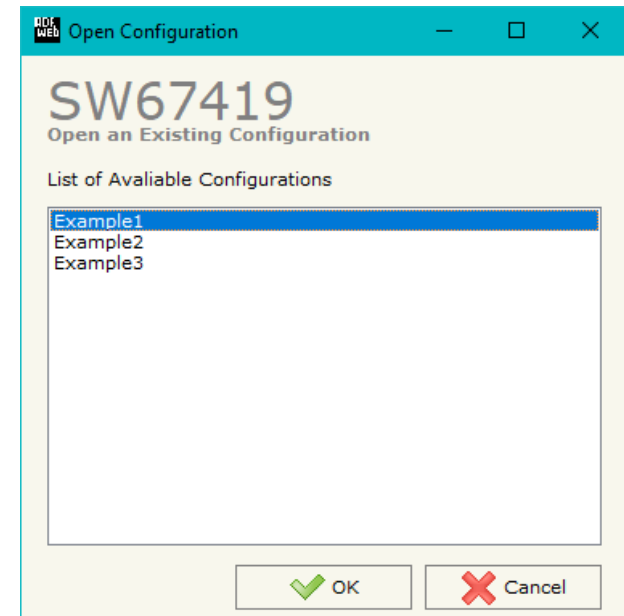

SOFTWARE OPTIONS:

By pressing the “**Settings**” () button there is the possibility to change the language of the software and check the updatings for the compositor.

In the section “Language” it is possible to change the language of the software.

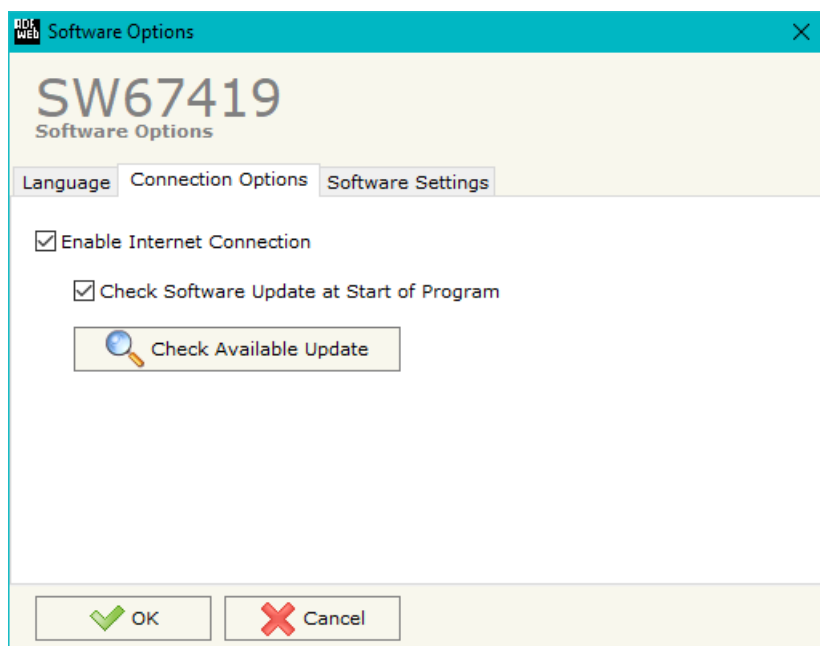

In the section “Connection Options”, it is possible to check if there are some updatings of the software compositor in ADFweb.com website. Checking the option “**Check Software Update at Start of Program**”, the SW67419 checks automatically if there are updatings when it is launched.

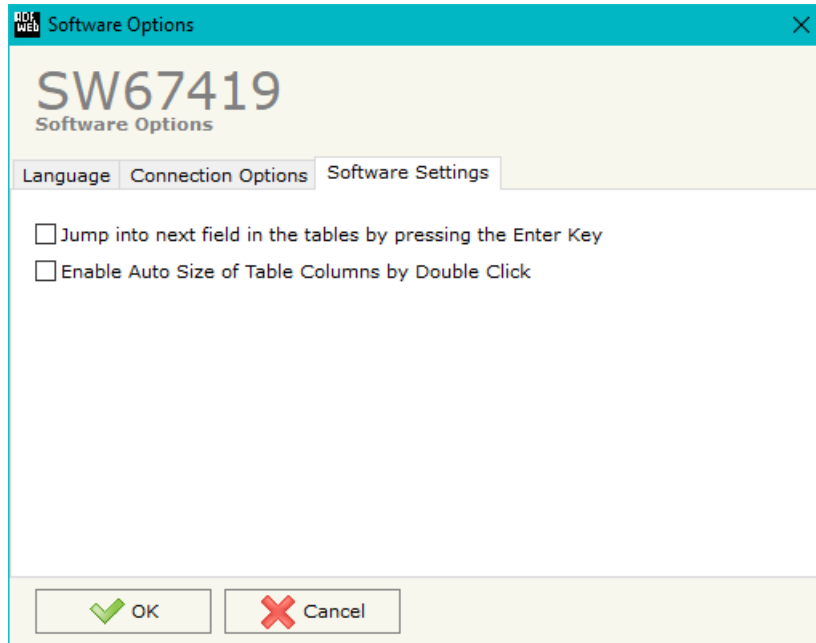

In the section "Software Settings", it is possible to enable/disable some keyboard's commands for an easier navigation inside the tables contained in the different sections of the software.

SET COMMUNICATION:

This section define the fundamental communication parameters of two buses, CAN and EtherNet/IP.

By Pressing the "**Set Communication**" button from the main window of SW67419 (Fig. 2) the window "Set Communication" appears (Fig. 3).

The meaning of the fields of "EtherNet/IP" are:

- In the field "**IP ADDRESS**" the IP address to assign to the converter is defined;
- In the field "**SUBNET Mask**" the SubNet Mask of the converter is defined;
- In the field "**GATEWAY**" the default gateway of the network is defined. This feature can be enabled or disabled pressing the Check Box field. This feature is used for going out of the net;
- In the field "**Port**" the number of port used for EtherNet/IP is defined (fixed to '44818');
- In the field "**Number Byte IN**" the number of byte from the Ethernet/IP Master to the converter is defined (it is possible to use up to 496 byte);
- In the field "**Number Byte OUT**" the number of byte from the converter to the Ethernet/IP Master is defined (it is possible to use up to 496 byte).

The means of the fields for the "CAN" section are:

- In the field "**Baudrate**" the data rate for the CAN is defined.

The screenshot shows the 'Set Communication' window for device SW67419. It is divided into two main sections: EtherNet/IP and CAN. The EtherNet/IP section contains several input fields: IP ADDRESS (192.168.2.136), SUBNET Mask (255.255.255.0), a GATEWAY checkbox (unchecked) with IP (192.168.2.1), Port (44818), Number Byte Input (20), and Number Byte Output (20). The CAN section contains a Baudrate dropdown menu set to 250K. At the bottom of the window are OK and Cancel buttons.

Figure 3: "Set Communication" window

RECEIVE FRAMES:

By pressing the **Receive Frames** button from the main window for SW67419 (Fig. 2) the "Receive CAN Frames" window appears (Fig. 4). The COB-IDs inserted in this table contain the output data of EtherNet/IP. These frames are accepted by the converter.

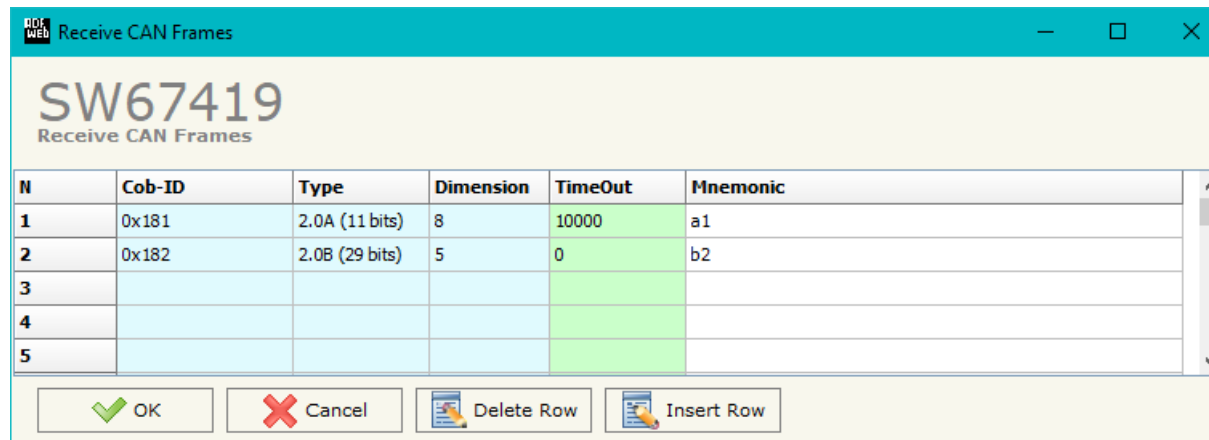

Figure 4: "Receive CAN Frames" window

The data of the columns have the following meanings:

- In the field **Cob-ID** the COB-ID of the CAN frame is defined;
- In the field **Type** the type of CAN message is defined (2.0A (11 bits) or 2.0B (29 bits));
- In the field **Dimension** the number of data bytes of the message (from 1 to 8) is defined;
- In the field **TimeOut** the time (in ms) of the timeout of the data is defined. If a CAN frame is not received in this time, all the data of the CAN frame will be set to '0'. It is possible to disable this function by setting this field to '0';
- In the field **Mnemonic** a brief description is defined.

INFO RECEIVE:

By pressing the “**Info Receive**” button from the main window for SW67419 (Fig. 2) the “Receive CAN Frames Info” window appears (Fig. 5):

- In the column “**COB ID**” there are the COB-IDs listed in the “Receive Frames” section;
- In the fields “**Bytes**” the bytes of the EtherNet/IP array of the converter where mapping the data from CAN are defined.

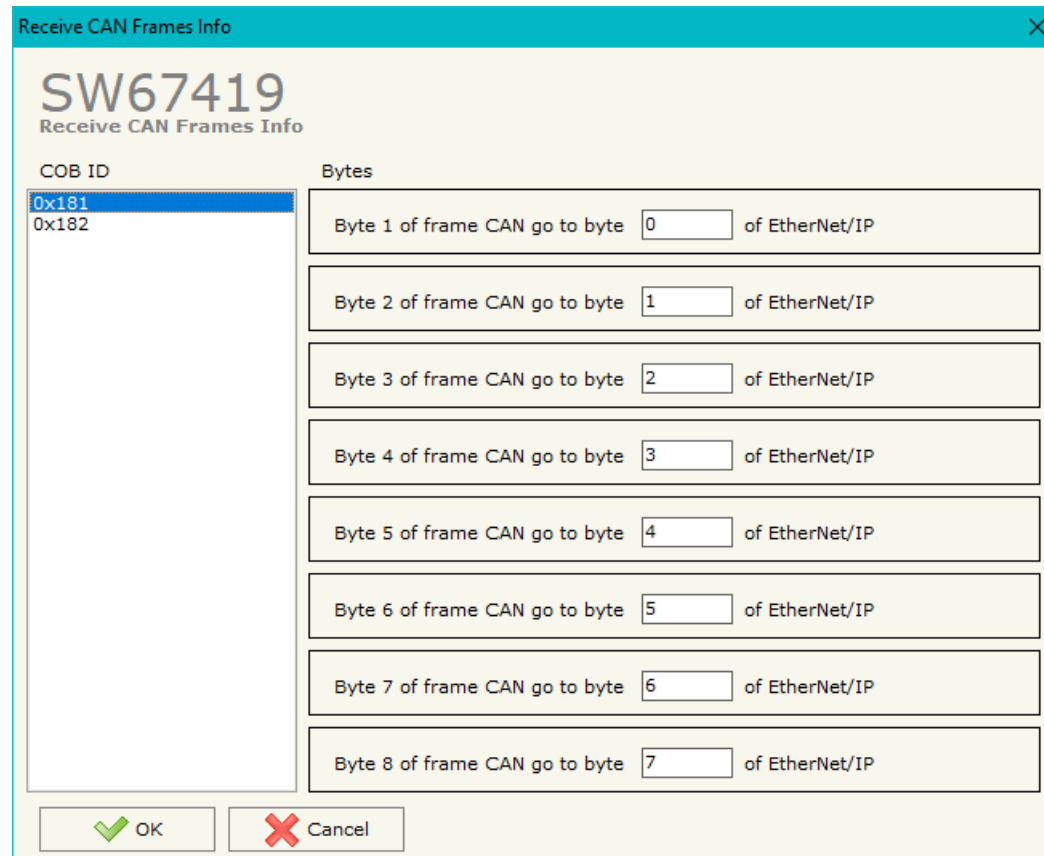
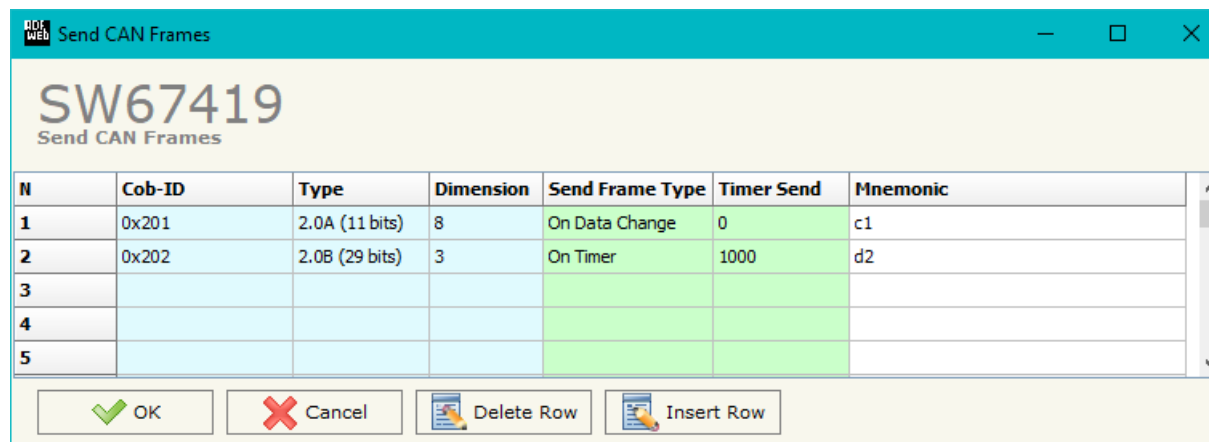

Figure 5: “Receive CAN Frames Info” window

SEND FRAMES:

By pressing the **Send Frames** button from the main window for SW67419 (Fig. 2) the "Send CAN frames" window appears (Fig. 6). The COB-IDs inserted in this table contain the input data of EtherNet/IP. These frames are sent by the converter.



N	Cob-ID	Type	Dimension	Send Frame Type	Timer Send	Mnemonic
1	0x201	2.0A (11 bits)	8	On Data Change	0	c1
2	0x202	2.0B (29 bits)	3	On Timer	1000	d2
3						
4						
5						

Figure 6: "Send CAN Frames" window

The data of the columns have the following meanings:

- ➔ In the field **Cob-ID** the COB-ID of the CAN frame is defined;
- ➔ In the field **Type** the type of CAN message sent is defined ('2.0A (11bits)' or '2.0B (29bits)');
- ➔ In the field **Dimension** the number of bytes of the CAN frame (from 1 to 8) is defined;
- ➔ In the field **Send Frame Type** the transmission type of the CAN frame is defined. There are two options:
 - **On Data Change**: the frame is sent when the data changes;
 - **On Times**: the frame is sent cyclically;
- ➔ In the field **Timer Send** the delay (in ms) between two CAN frames is defined (if the option **On Timer** is checked);
- ➔ In the field **Mnemonic** a brief description is defined.

INFO SEND:

By pressing the **Info Send** button from the main window for SW67419 (Fig. 2) the "Send CAN Frames Info" window appears (Fig. 7):

- In the column **COB ID** there are the COB-IDs listed in the "Send Frames" section;
- In the fields **Bytes** the bytes of the EtherNet/IP array of the converter where taking the data to send on CAN are defined.

COB ID	Bytes
0x201	Byte 1 of frame CAN go to byte <input type="text" value="0"/> of EtherNet/IP
0x202	Byte 2 of frame CAN go to byte <input type="text" value="1"/> of EtherNet/IP
	Byte 3 of frame CAN go to byte <input type="text" value="2"/> of EtherNet/IP
	Byte 4 of frame CAN go to byte <input type="text" value="3"/> of EtherNet/IP
	Byte 5 of frame CAN go to byte <input type="text" value="4"/> of EtherNet/IP
	Byte 6 of frame CAN go to byte <input type="text" value="5"/> of EtherNet/IP
	Byte 7 of frame CAN go to byte <input type="text" value="6"/> of EtherNet/IP
	Byte 8 of frame CAN go to byte <input type="text" value="7"/> of EtherNet/IP

Figure 7: "Send Frames Info" window

UPDATE DEVICE:

By pressing the **Update Device** button, it is possible to load the created Configuration into the device; and also the Firmware, if necessary.

If you don't know the actual IP address of the device you have to use this procedure:

- Connect the USB cable;
- Connect the Ethernet cable;
- Turn ON the converter;
- Insert the IP **"192.168.2.205"**;
- Press the **Ping** button, "Device Found! must appear";
- Press the **Next** button;
- Select which operations you want to do;
- Press the **Execute update firmware** button to start the upload;
- When all the operations are "OK", the updating is done;
- Remove the USB cable;

At this point the configuration/firmware on the device is correctly updated.

If you know the actual IP address of the device, you have to use this procedure:

- Turn on the Device with the Ethernet cable inserted;
- Insert the actual IP of the Converter;
- Press the **Ping** button, must appear "Device Found!";
- Press the **Next** button;
- Select which operations you want to do;
- Press the **Execute update firmware** button to start the upload;
- When all the operations are "OK" the device automatically goes at Normal Mode.



Note:

When you install a new version of the software, if it is the first time it is better you do the update of the Firmware in the HD67419 device.

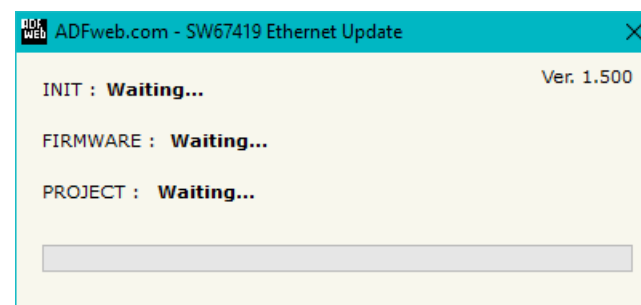
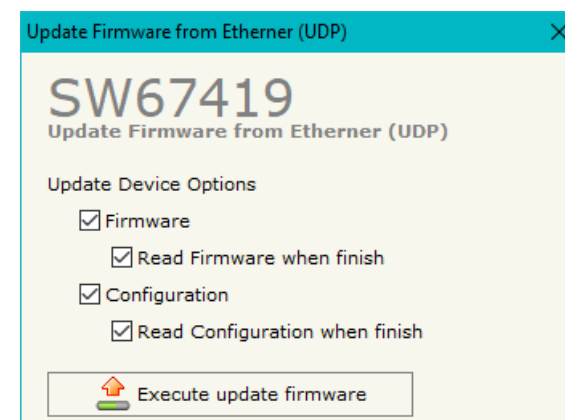
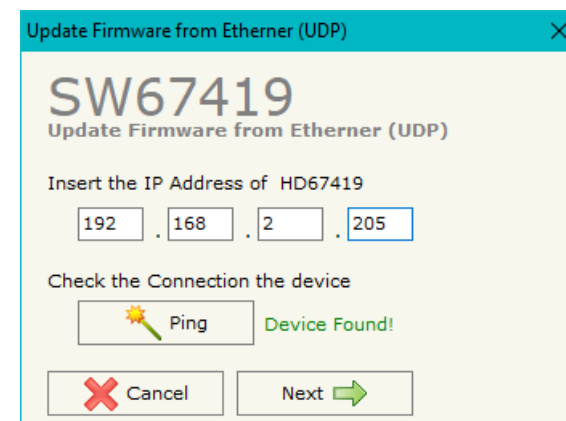

Figure 8: "Update Device" windows

**Note:**

When you receive the device, for the first time, you also have to update the Firmware in the HD67419 device.

**Warning:**

If Fig. 9 appears when you try to do the Update try these points before seeking assistance:

- Try to repeat the operations for the updating;
- Try with another PC;
- Try to restart the PC;
- Check the LAN settings;
- If you are using the program inside a Virtual Machine, try to use in the main Operating System;
- If you are using Windows Seven, Vista, 8 or 10 make sure that you have the administrator privileges;
- In case you have to program more than one device, using the "UDP Update", you have to cancel the ARP table every time you connect a new device on Ethernet. For do this you have to launch the "Command Prompt" and write the command "arp -d". Pay attention that with Windows Vista, Seven, 8, 10 you have to launch the "Command Prompt" with Administrator Rights;
- Pay attention at Firewall lock.

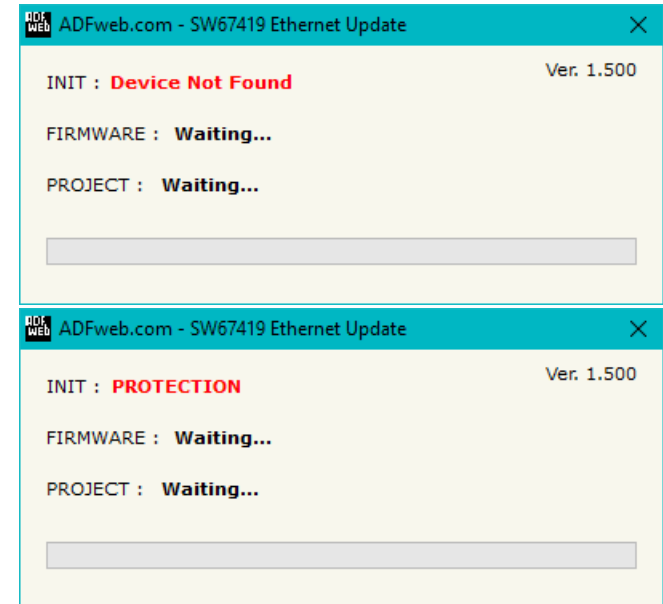
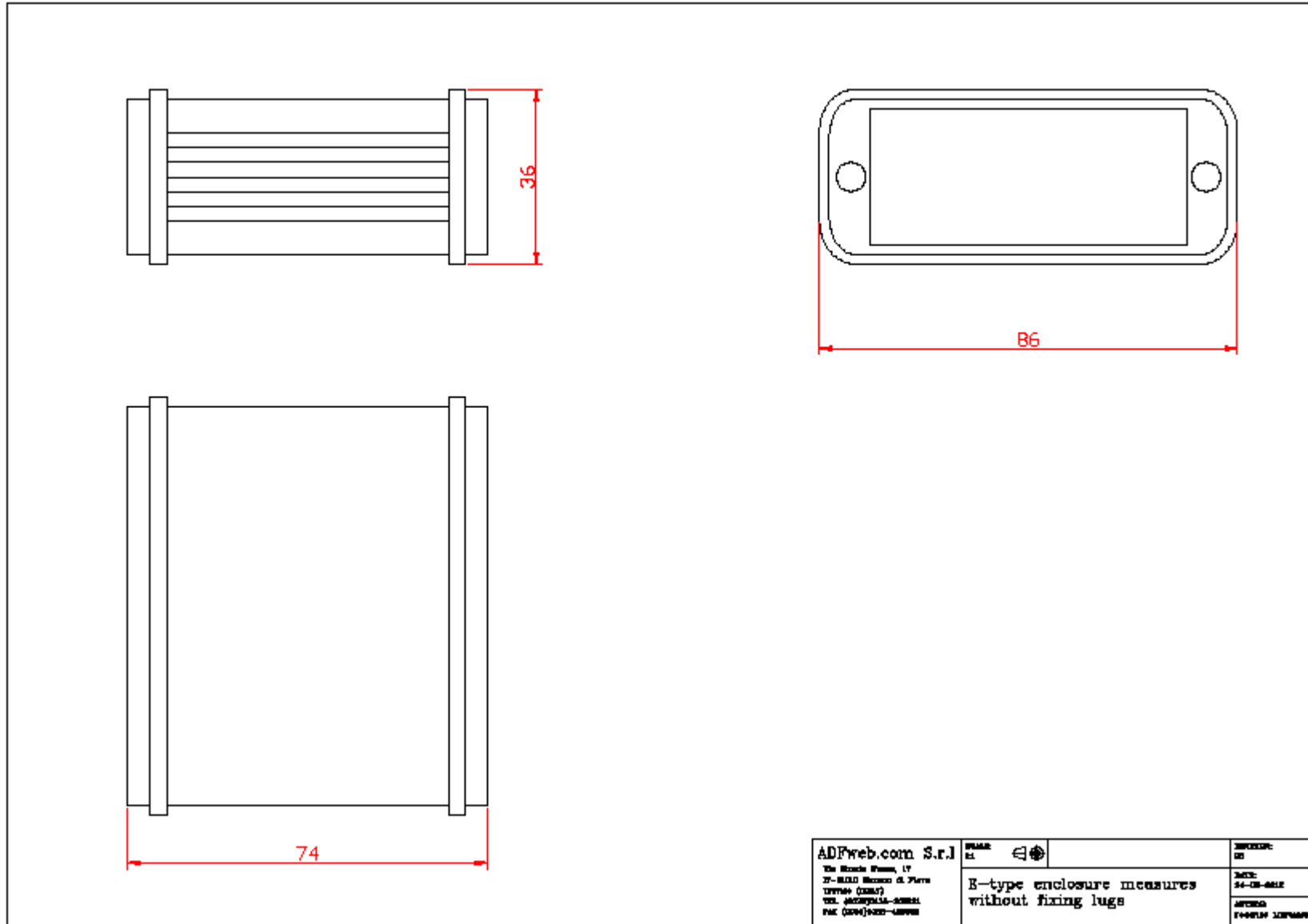
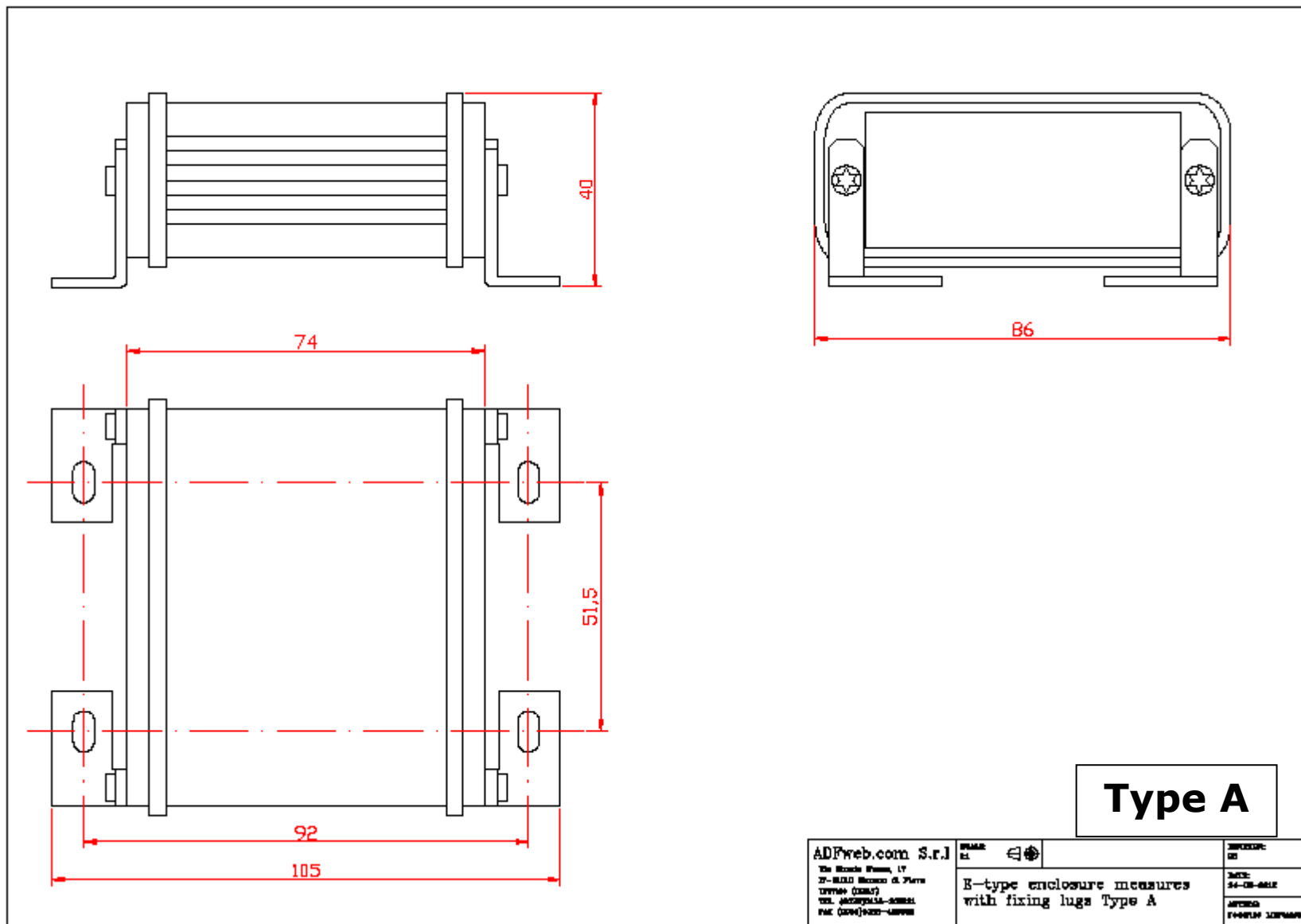

Figure 9: "Protection" window

In the case of HD67419 you have to use the software "SW67419": www.adfweb.com/download/filefold/SW67419.zip.

MECHANICAL DIMENSIONS:





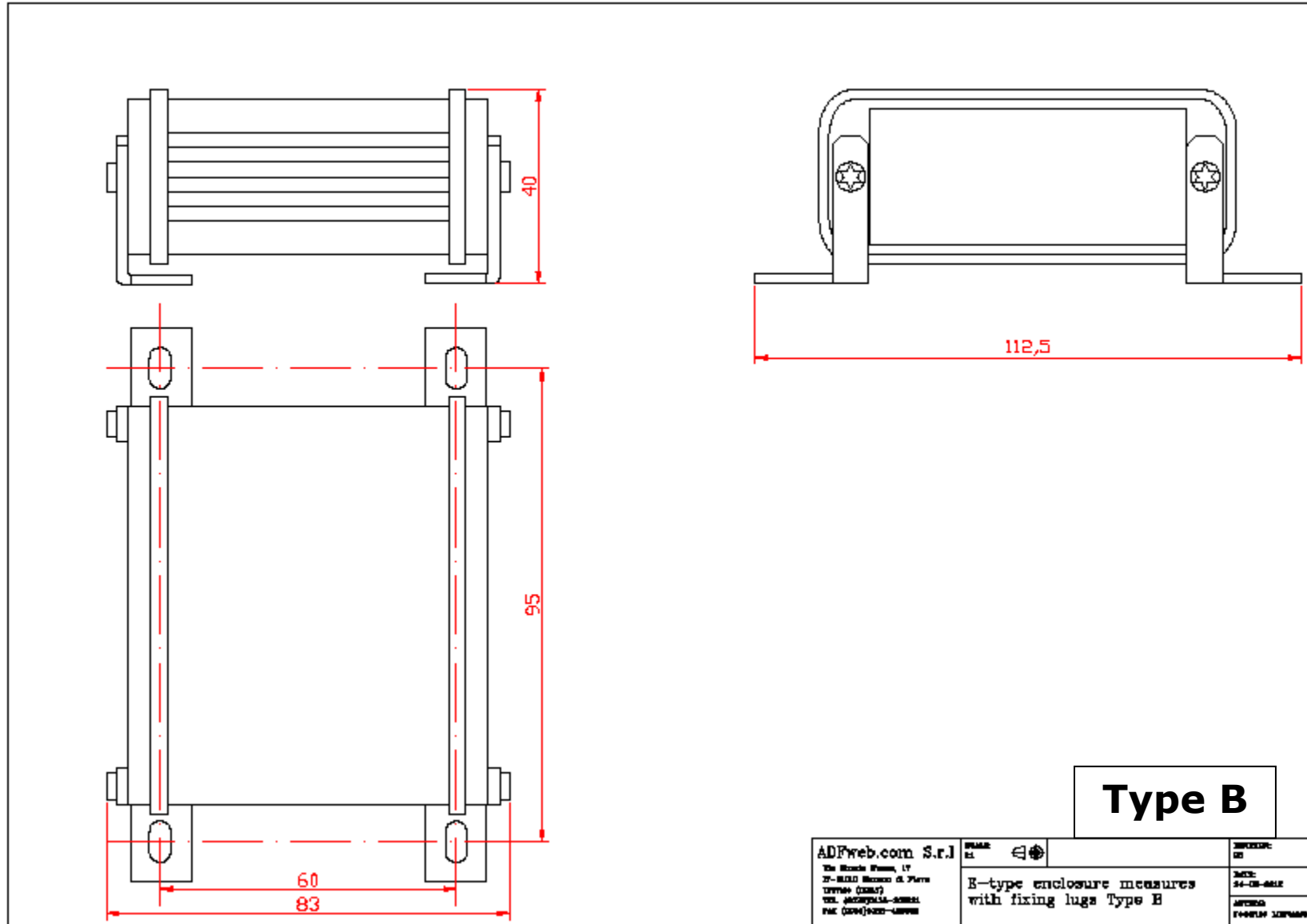

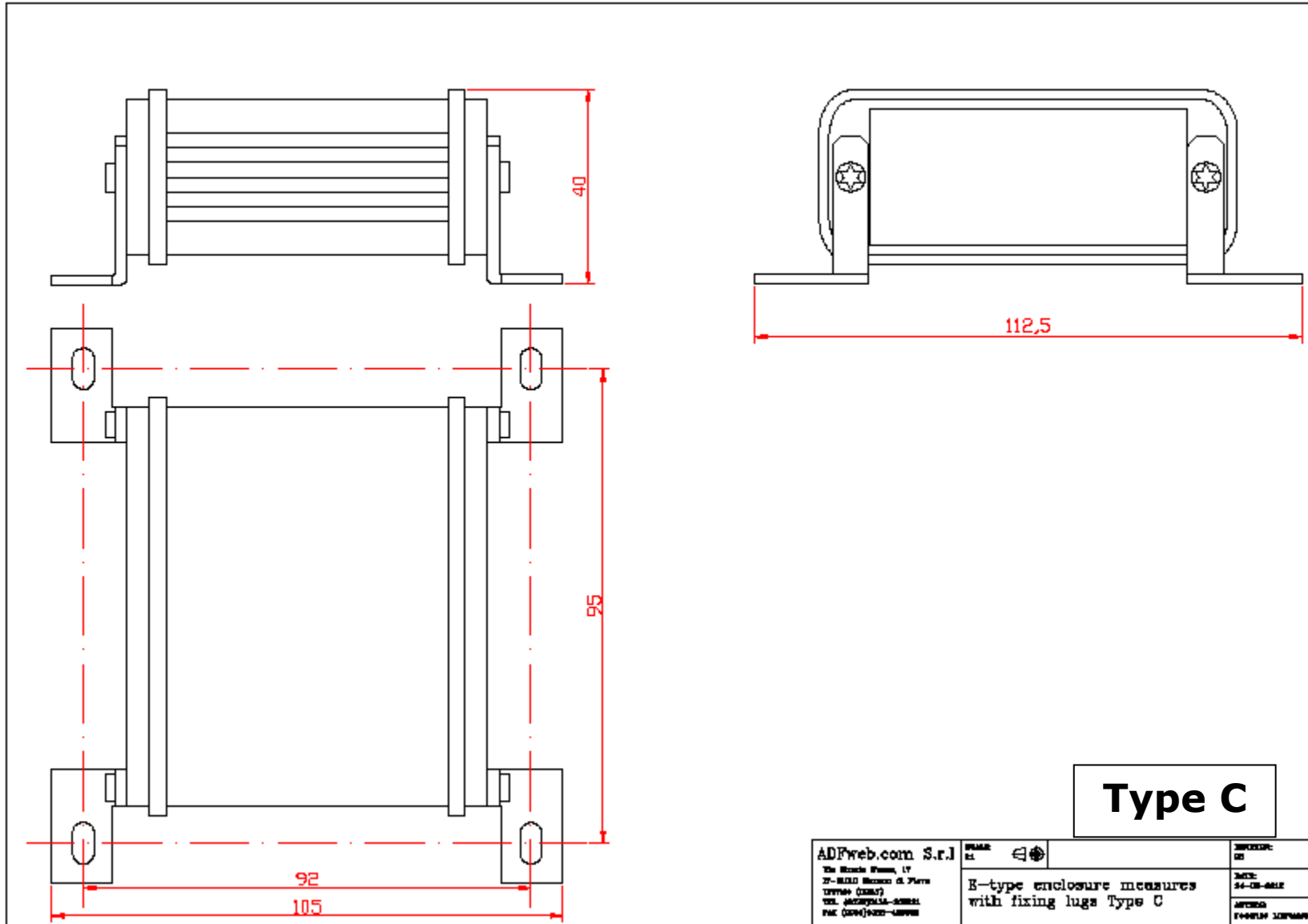

ORDERING INFORMATIONS:

The ordering part number is formed by a valid combination of the following:

HD67419 - E y z - s f

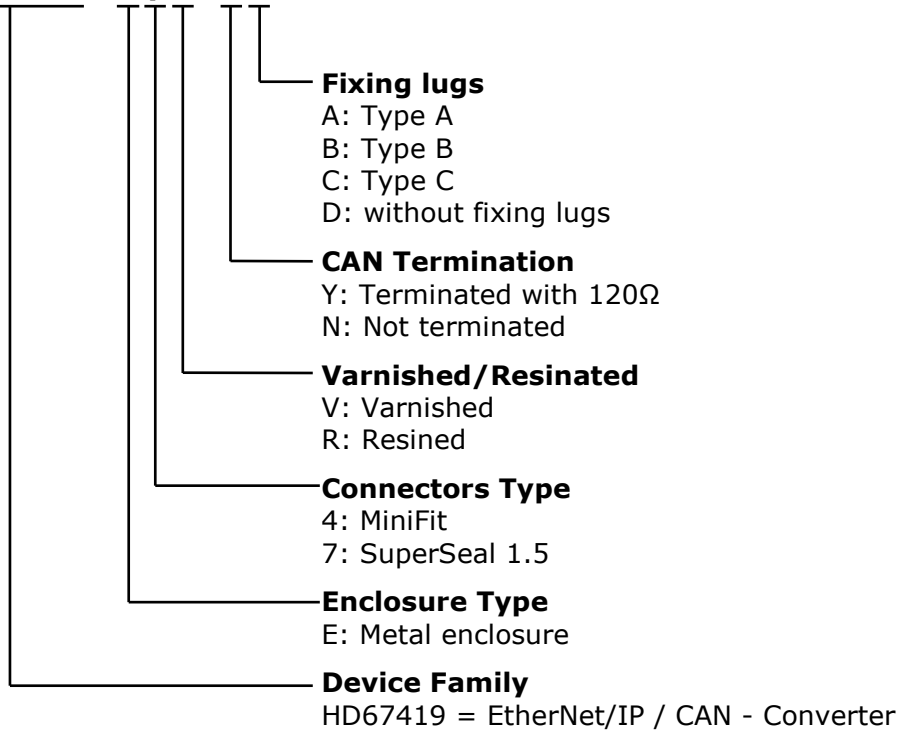

ACCESSORIES:

- Order Code: **AC34001** - Rail DIN - Power Supply 220/240V AC 50/60Hz – 12 V AC
- Order Code: **AC34002** - Rail DIN - Power Supply 110V AC 50/60Hz – 12 V AC
- Order Code: **AC67402** - Cable Super Seal 1.5 MALE 2-pole - 1.0 Meter
- Order Code: **AC67402-3** - Cable Super Seal 1.5 MALE 2-pole - 3.0 Meters
- Order Code: **AC67403** - Cable Super Seal 1.5 MALE 3-pole - 1.0 Meter
- Order Code: **AC67403-3** - Cable Super Seal 1.5 MALE 3-pole - 3.0 Meters
- Order Code: **AC67404** - Cable Super Seal 1.5 MALE 4-pole - 1.0 Meter
- Order Code: **AC67404-3** - Cable Super Seal 1.5 MALE 4-pole - 3.0 Meters
- Order Code: **AC67410** - Accessory Automotive Devices - Support for rail DIN

PLC CONFIGURATION:

The configuration and commissioning of the EtherNet/IP Converter as described on the following pages was accomplished with the help of the "RSLogix 5000" software of Rockwell Automation. In case of using a control system from another supplier please attend to the associated documentation.

These are the steps to follow:

- 1) Create a "Generic Ethernet Module" under the Ethernet section in the I/O Configuration tree.

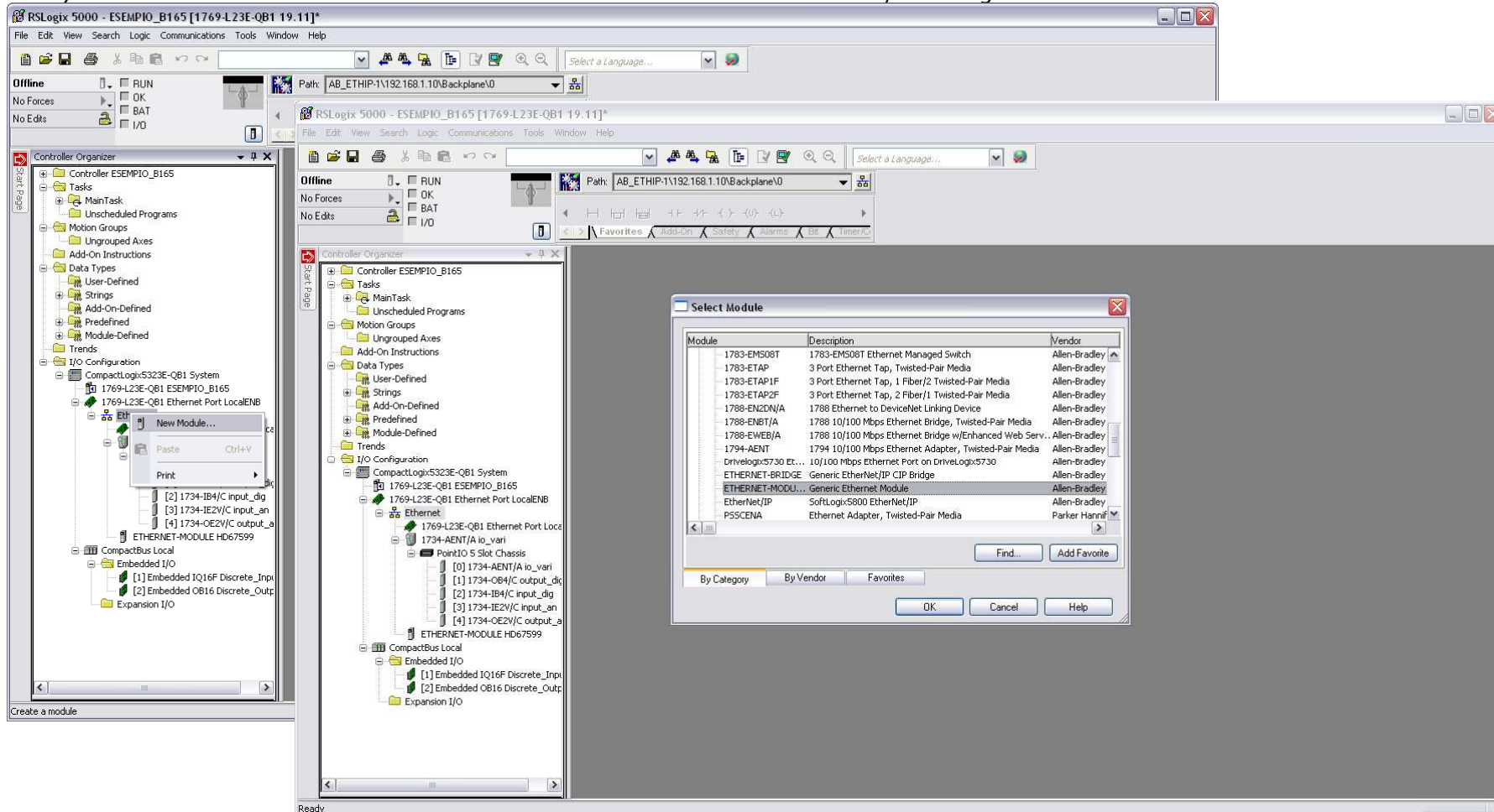

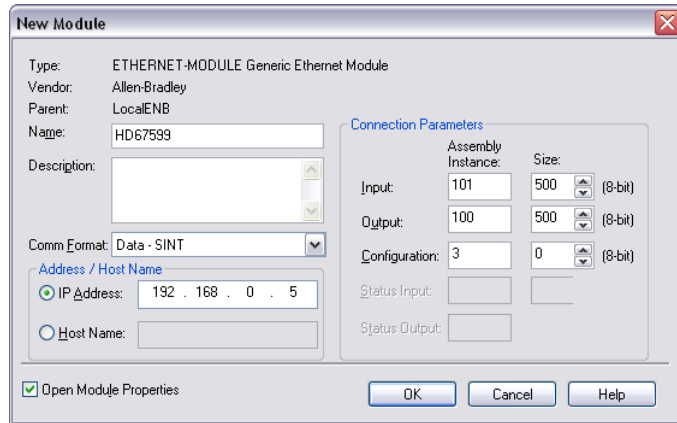

2) Edit the settings of the new Generic Ethernet Module. As shown in the screen shot below, the module was named "HD67419" and the IP-address assigned is 192.168.0.5.

For the Comm Format "Data - SINT" shall be selected as the data type.

The HD67419 can uses up to 496 bytes for input assembly instance 101 and 496 bytes for output assembly instance 100.

RSLogix 5000 requires a configuration assembly instance. Both modules do not provide a configuration assembly instance. Therefore it is allowed to select an instance of 3 and to set the value to zero.

3) The setting of 10msec for the "Requested Packet Interval (RPI)" is adequate but it is possible to change this value as required. A lower value of 2ms shall not be selected.



Warning:

The field "Use Unicast Connection over EtherNet/IP" must be checked.

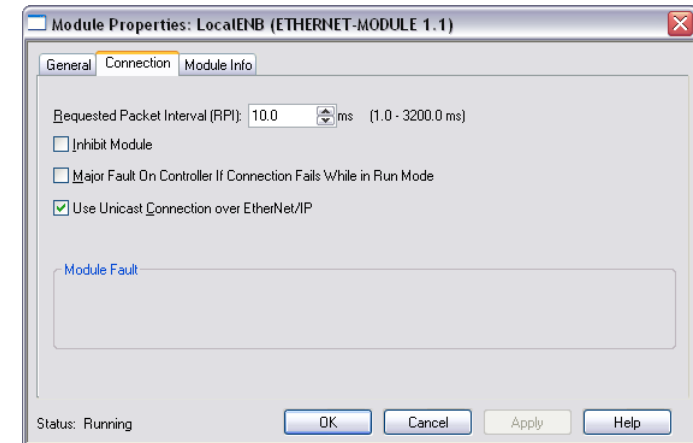

4) After the configuration is completed, the controller tags are created.

The screenshot shows the RSLogix 5000 software interface. On the left, the 'Controller Organizer' tree displays the project structure for 'ESEMPIO_B165'. The main window shows a list of controller tags under the scope 'ESEMPIO_B165'. The tags are organized into several categories:

- Controller Tags:** HD675991, HD67593, HD67592, HD67591, HD67590, HD67589, HD67588, HD67587, HD67586, HD67585, HD67584, HD67583, HD67582, HD67581, HD67580, HD67579, HD67578, HD67577, HD67576, HD67575, HD67574, HD67573, HD67572, HD67571, HD67570, HD67569, HD67568, HD67567, HD67566, HD67565, HD67564, HD67563, HD67562, HD67561, HD67560, HD67559, HD67558, HD67557, HD67556, HD67555, HD67554, HD67553, HD67552, HD67551, HD67550, HD67549, HD67548, HD67547, HD67546, HD67545, HD67544, HD67543, HD67542, HD67541, HD67540, HD67539, HD67538, HD67537, HD67536, HD67535, HD67534, HD67533, HD67532, HD67531, HD67530, HD67529, HD67528, HD67527, HD67526, HD67525, HD67524, HD67523, HD67522, HD67521, HD67520, HD67519, HD67518, HD67517, HD67516, HD67515, HD67514, HD67513, HD67512, HD67511, HD67510, HD67509, HD67508, HD67507, HD67506, HD67505, HD67504, HD67503, HD67502, HD67501, HD67500.
- Tasks:** MainTask, MainProgram, Unscheduled Programs.
- Motion Groups:** Ungrouped Axes.
- Add-On Instructions:** Data Types, User-Defined, Strings, Add-On-Defined, Predefined, Module-Defined, Trends.
- I/O Configuration:** CompactLogix5323E-QB1 System, 1769-L23E-QB1 ESEMPIO_B165, 1769-L23E-QB1 Ethernet Port LocalENB, Ethernet, 1769-L23E-QB1 Ethernet Port LocalENB, 1734-AENT/A io_vari, PointIO 5 Slot Chassis, [0] 1734-AENT/A io_vari, [1] 1734-OB4/C output_dig, [2] 1734-IB4/C input_dig, [3] 1734-IE2V/C input_an, [4] 1734-OE2V/C output_a, ETHERNET-MODULE HD67599, CompactBus Local, Embedded I/O, [1] Embedded IQ16F Discrete_Inpt, [2] Embedded OB16 Discrete_Outp, Expansion I/O.

5) With "RSLinks Classic Lite", after have done a network scan (RSWho), and finding the EtherNet/IP device, it is possible to load the EDS file for the device in order to have the "Module Info" compiled.

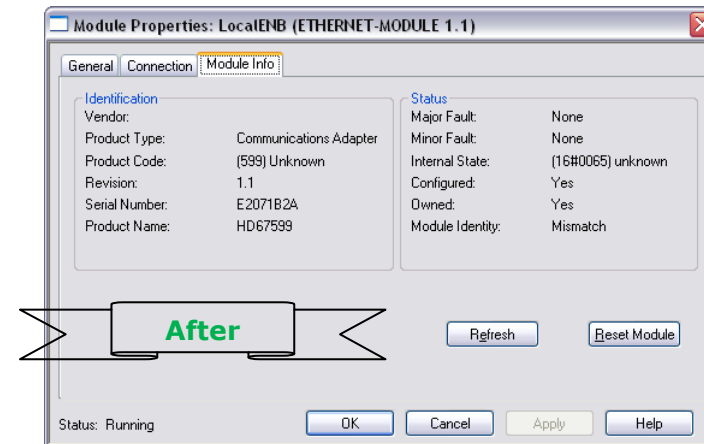
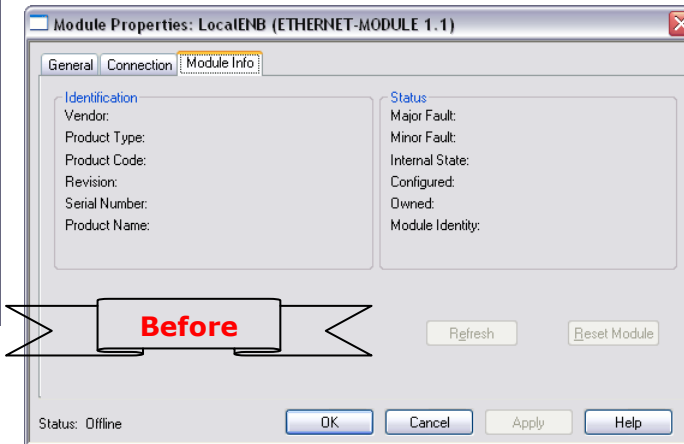
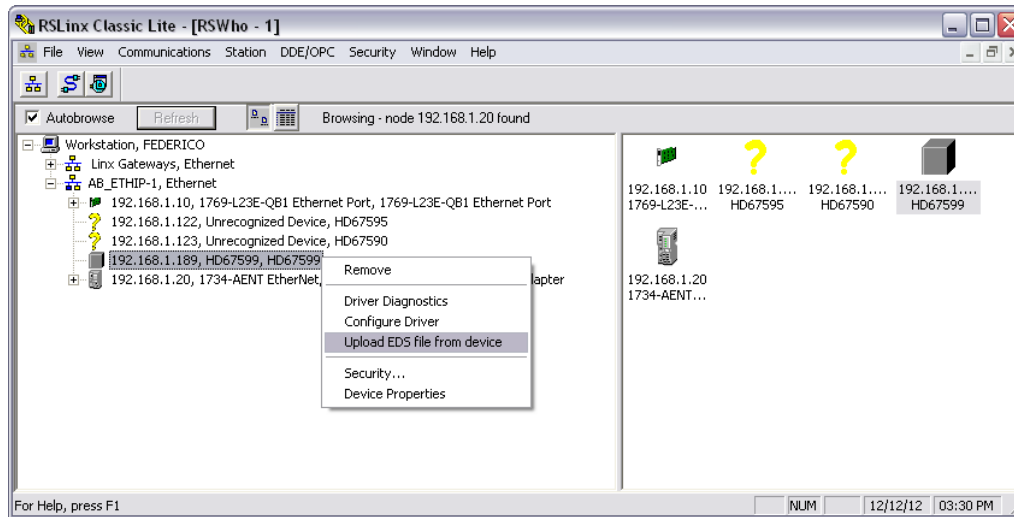

DISCLAIMER:

All technical content within this document can be modified without notice. The content of the document is a under continual renewal. For losses due to fire, earthquake, third party access or other accidents, or intentional or accidental abuse, misuse, or use under abnormal conditions repairs are charged to the user. ADFweb.com S.r.l. will not be liable for accidental loss of use or inability to use this product, such as loss of business income. ADFweb.com S.r.l. shall not be liable for consequences of improper use.

OTHER REGULATIONS AND STANDARDS:**WEEE INFORMATION**

Disposal of old electrical and electronic equipment (as in the European Union and other European countries with separate collection systems).

— This symbol on the product or on its packaging indicates that this product may not be treated as household rubbish. Instead, it should be taken to an applicable collection point for the recycling of electrical and electronic equipment. If the product is disposed correctly, you will help prevent potential negative environmental factors and impact of human health, which could otherwise be caused by inappropriate disposal. The recycling of materials will help to conserve natural resources. For more information about recycling this product, please contact your local city office, your household waste disposal service or the shop where you purchased the product.

RESTRICTION OF HAZARDOUS SUBSTANCES DIRECTIVE

The device respects the 2002/95/EC Directive on the restriction of the use of certain hazardous substances in electrical and electronic equipment (commonly referred to as Restriction of Hazardous Substances Directive or RoHS).

CE MARKING

The product conforms with the essential requirements of the applicable EC directives.

WARRANTIES AND TECHNICAL SUPPORT:

For fast and easy technical support for your ADFweb.com SRL products, consult our internet support at www.adfweb.com.
Otherwise contact us at the address support@adfweb.com

RETURN POLICY:

If while using your product you have any problem and you wish to exchange or repair it, please do the following:

- Obtain a Product Return Number (PRN) from our internet support at www.adfweb.com. Together with the request, you need to provide detailed information about the problem.
- Send the product to the address provided with the PRN, having prepaid the shipping costs (shipment costs billed to us will not be accepted).

If the product is within the warranty of twelve months, it will be repaired or exchanged and returned within three weeks. If the product is no longer under warranty, you will receive a repair estimate.



ADFweb.com S.r.l.
Via Strada Nuova, 17
IT-31010 Mareno di Piave
TREVISO (Italy)
Phone +39.0438.30.91.31
Fax +39.0438.49.20.99
www.adfweb.com

