

User Manual

Revision 2.400
English

Modbus TCP Slave / Modbus Master - Converter

(Order Code: HD67507-A1, HD67507-A1-422, HD67507-B2, HD67507-Slim-232, HD67507-Slim-485, HD67507-WiFi-B2-232, HD67507-WiFi-B2-485)

for Website information:

www.adfweb.com?Product=HD67507

for Price information:

www.adfweb.com?Price=HD67507-A1

www.adfweb.com?Price=HD67507-A1-422

www.adfweb.com?Price=HD67507-B2

www.adfweb.com?Price=HD67507-Slim-232

www.adfweb.com?Price=HD67507-Slim-485

www.adfweb.com?Price=HD67507-WiFi-B2-232

www.adfweb.com?Price=HD67507-WiFi-B2-485

Benefits and Main Features:

- ⊕ Wide supply input range
- ⊕ Galvanic Isolation
- ⊕ Temperature range: -40°C/+85°C (-40°F/+185°F)

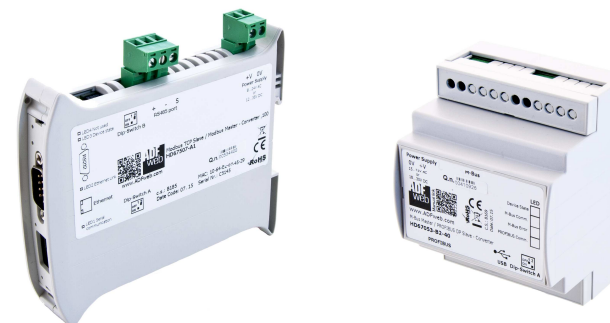

For others products, see also the following links:

RS232 / RS485 / USB / Ethernet

www.adfweb.com?Product=HD67118 (RS232 / RS485 - Converter)

www.adfweb.com?Product=HD67119 (USB / RS485 - Converter)

www.adfweb.com?Product=HD67038 (RS485 / RS232 / Ethernet - Converter)

CAN / CANopen / Modbus / Modbus TCP

www.adfweb.com?Product=HD67001 (CANopen / Modbus Master - Converter)

www.adfweb.com?Product=HD67502 (CANopen / Modbus Slave - Converter)

www.adfweb.com?Product=HD67011 (CAN / Modbus Master - Converter)

www.adfweb.com?Product=HD67012 (CAN / Modbus Slave - Converter)

www.adfweb.com?Product=HD67514 (CAN / Modbus TCP Master - Converter)

www.adfweb.com?Product=HD67515 (CAN / Modbus TCP Slave - Converter)

Modbus RTU Slave / Modbus TCP Master - Converter

www.adfweb.com?Product=HD67510

Do you have your customer protocol? Then go to:

www.adfweb.com?Product=HD67003

Do you need to choose a device? Do you want help?

www.adfweb.com?Cmd=helpme



User Manual

INDEX:

	Page
INDEX	2
UPDATED DOCUMENTATION	2
REVISION LIST	2
WARNING	2
TRADEMARKS	2
SECURITY ALERT	3
EXAMPLES OF CONNECTION	4
CONNECTION SCHEME	6
CHARACTERISTICS	13
CONFIGURATION	13
POWER SUPPLY	14
FUNCTION MODES	15
LEDS (for HD67507-A1 and HD67507-B2)	16
LEDS (for HD67507-Slim-xxx)	17
LEDS (for HD67507-WiFi-B2)	18
ETHERNET	19
WI-FI	19
RS232	20
RS485	21
RS422	22
USE OF COMPOSITOR SW67507	23
NEW PROJECT / OPEN PROJECT	24
SOFTWARE OPTIONS	25
SET COMMUNICATION	26
OPERATION MODE	33
TRANSLATE TABLE	34
UPDATE VIA UDP	36
MECHANICAL DIMENSIONS	38
ORDERING INFORMATIONS	42
ACCESSORIES	43
DISCLAIMER	44
OTHER REGULATIONS AND STANDARDS	44
WARRANTIES AND TECHNICAL SUPPORT	45
RETURN POLICY	45

UPDATED DOCUMENTATION:

Dear customer, we thank you for your attention and we remind you that you need to check that the following document is:

- Updated
- Related to the product you own

To obtain the most recently updated document, note the “document code” that appears at the top right-hand corner of each page of this document.

With this “Document Code” go to web page www.adfweb.com/download/ and search for the corresponding code on the page. Click on the proper “Document Code” and download the updates.

REVISION LIST:

Revision	Date	Author	Chapter	Description
2.100	14/07/2014	Ff	All	Added chapters
2.200	27/12/2017	Ff	All	New Hardware for Wi-Fi
2.300	04/01/2023	Ff	All	Added Slim version
2.400	26/01/2023	Ff	All	New Hardware for Wi-Fi

WARNING:

ADFweb.com reserves the right to change information in this manual about our product without warning. ADFweb.com is not responsible for any error this manual may contain.

TRADEMARKS:

All trademarks mentioned in this document belong to their respective owners.

SECURITY ALERT:**GENERAL INFORMATION**

To ensure safe operation, the device must be operated according to the instructions in the manual. When using the device are required for each individual application, legal and safety regulation. The same applies also when using accessories.

INTENDED USE

Machines and systems must be designed so the faulty conditions do not lead to a dangerous situation for the operator (i.e. independent limit switches, mechanical interlocks, etc.).

QUALIFIED PERSONNEL

The device can be used only by qualified personnel, strictly in accordance with the specifications.

Qualified personnel are persons who are familiar with the installation, assembly, commissioning and operation of this equipment and who have appropriate qualifications for their job.

RESIDUAL RISKS

The device is state of the art and is safe. The instrument can represent a potential hazard if they are inappropriately installed and operated by personnel untrained. These instructions refer to residual risks with the following symbol:

 This symbol indicates that non-observance of the safety instructions is danger for people to serious injury or death and / or the possibility of damage.

CE CONFORMITY

The declaration is made by us. You can send an email to support@adfweb.com or give us a call if you need it.

EXAMPLES OF CONNECTION:

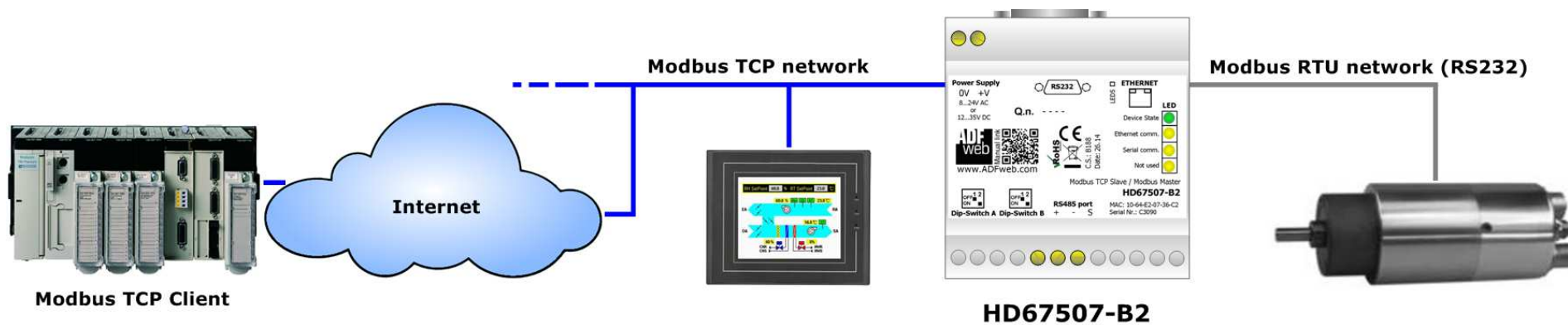
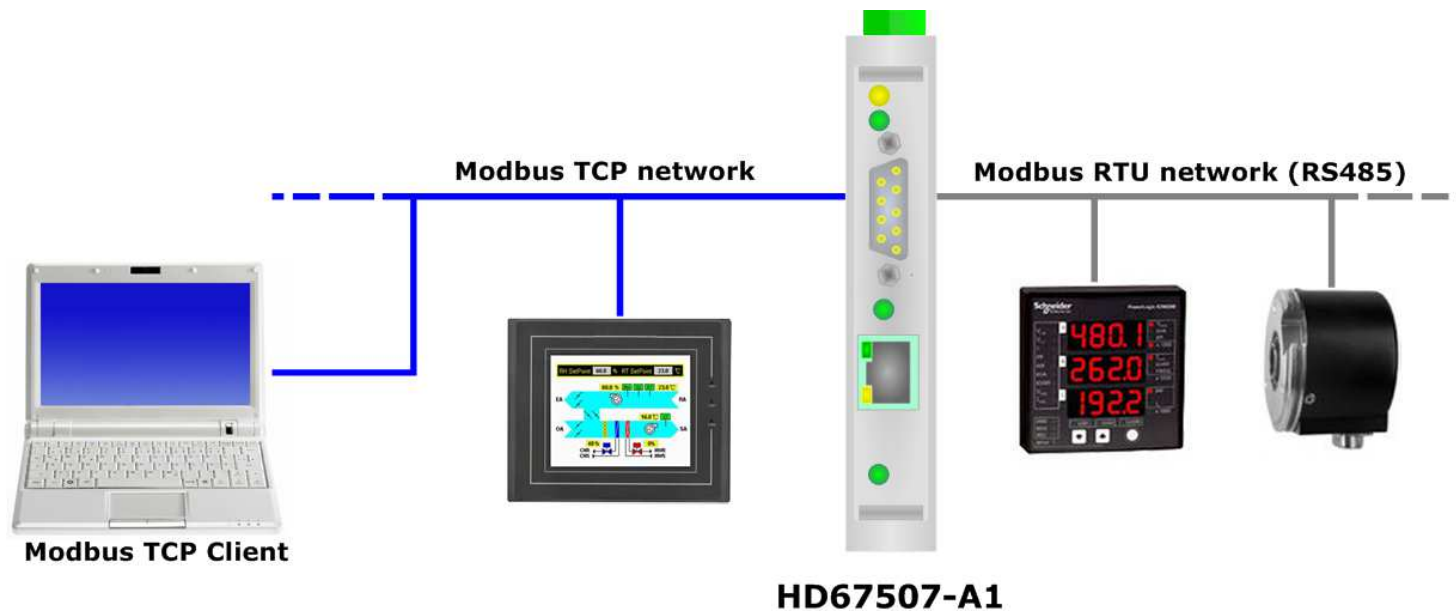

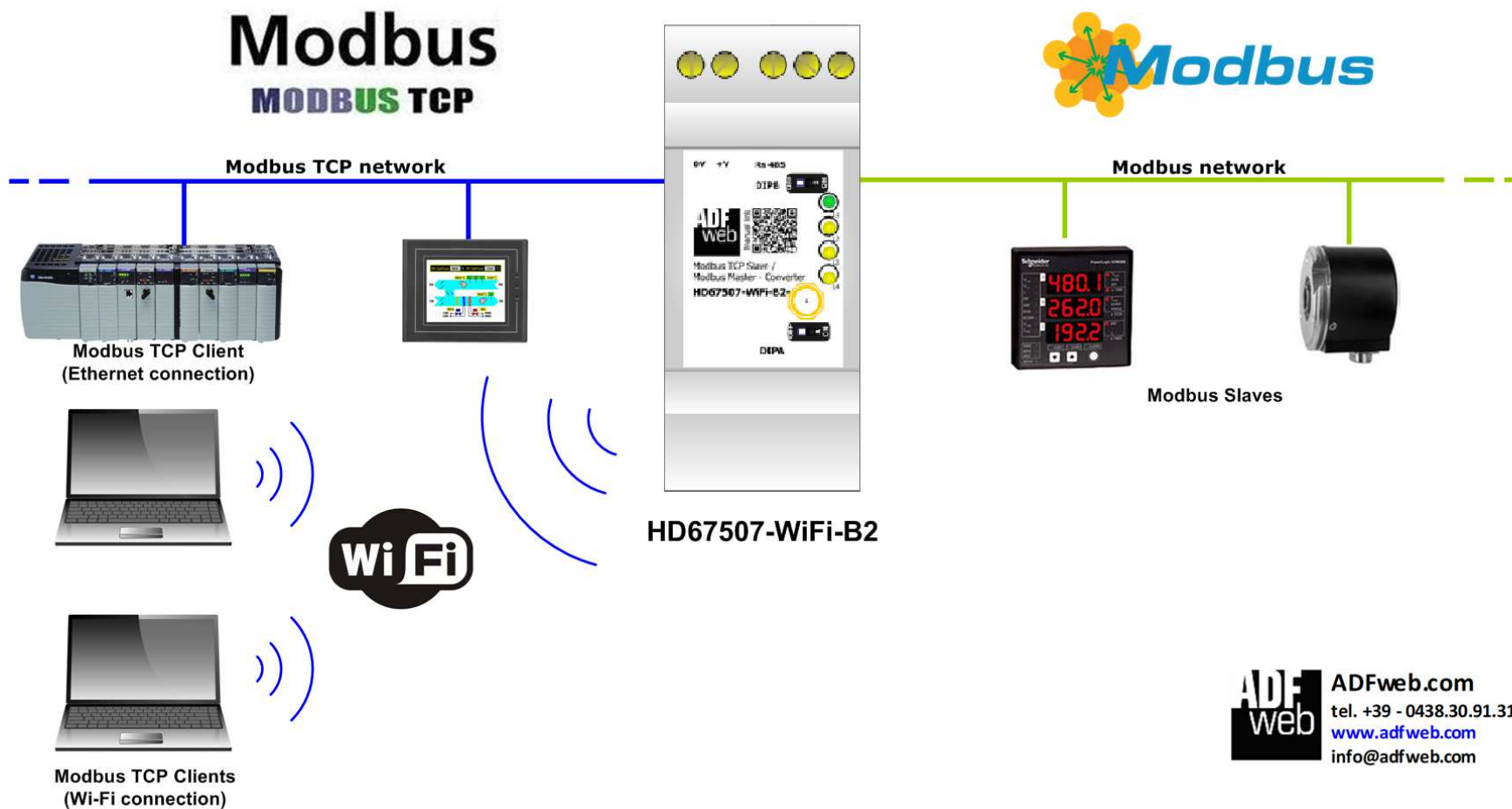

 **ADFweb.com**
tel. +39 - 0438.30.91.31
www.adfweb.com
info@adfweb.com

CONNECTION SCHEME:

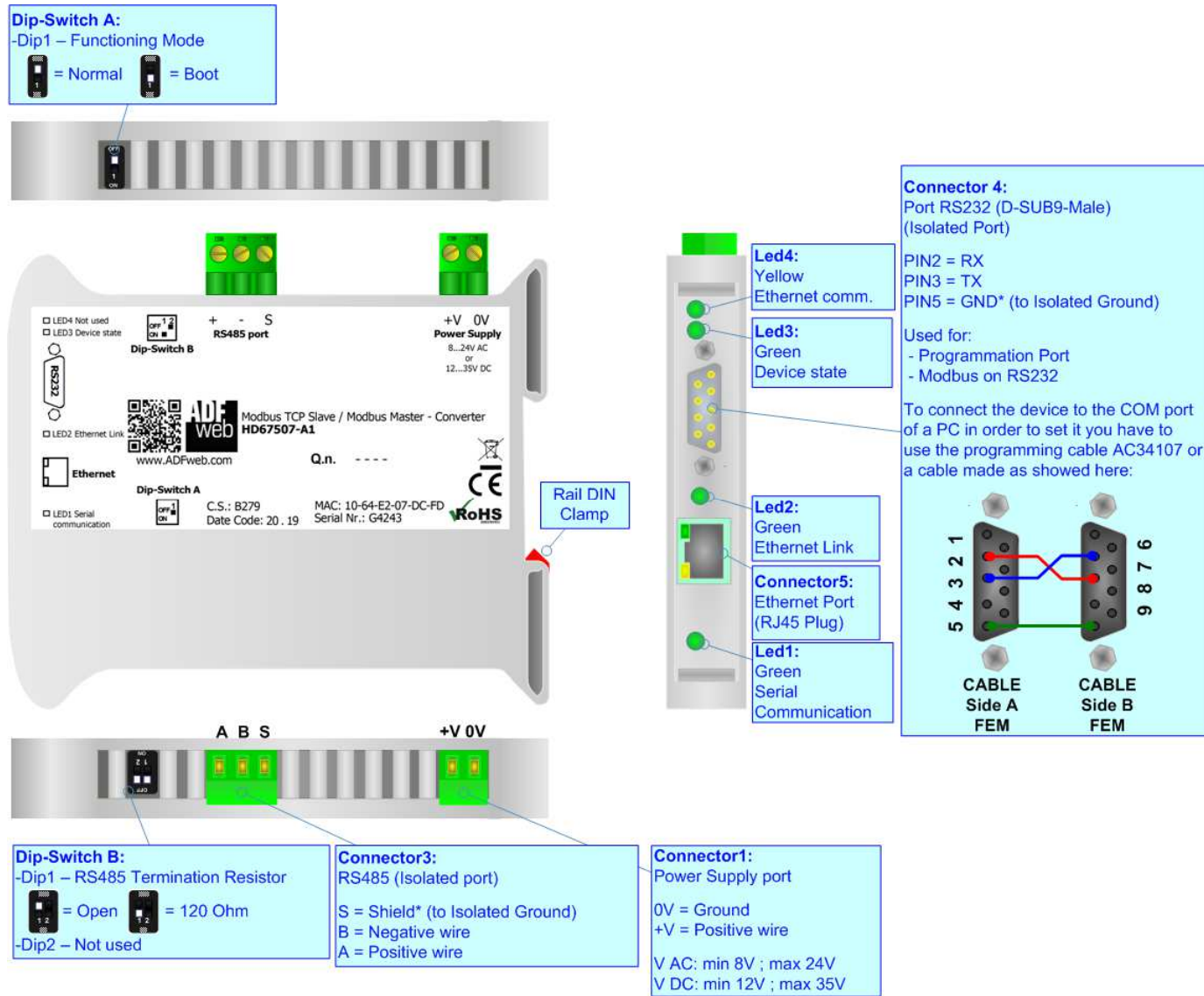

Figure 1a: Connection scheme for HD67507-A1

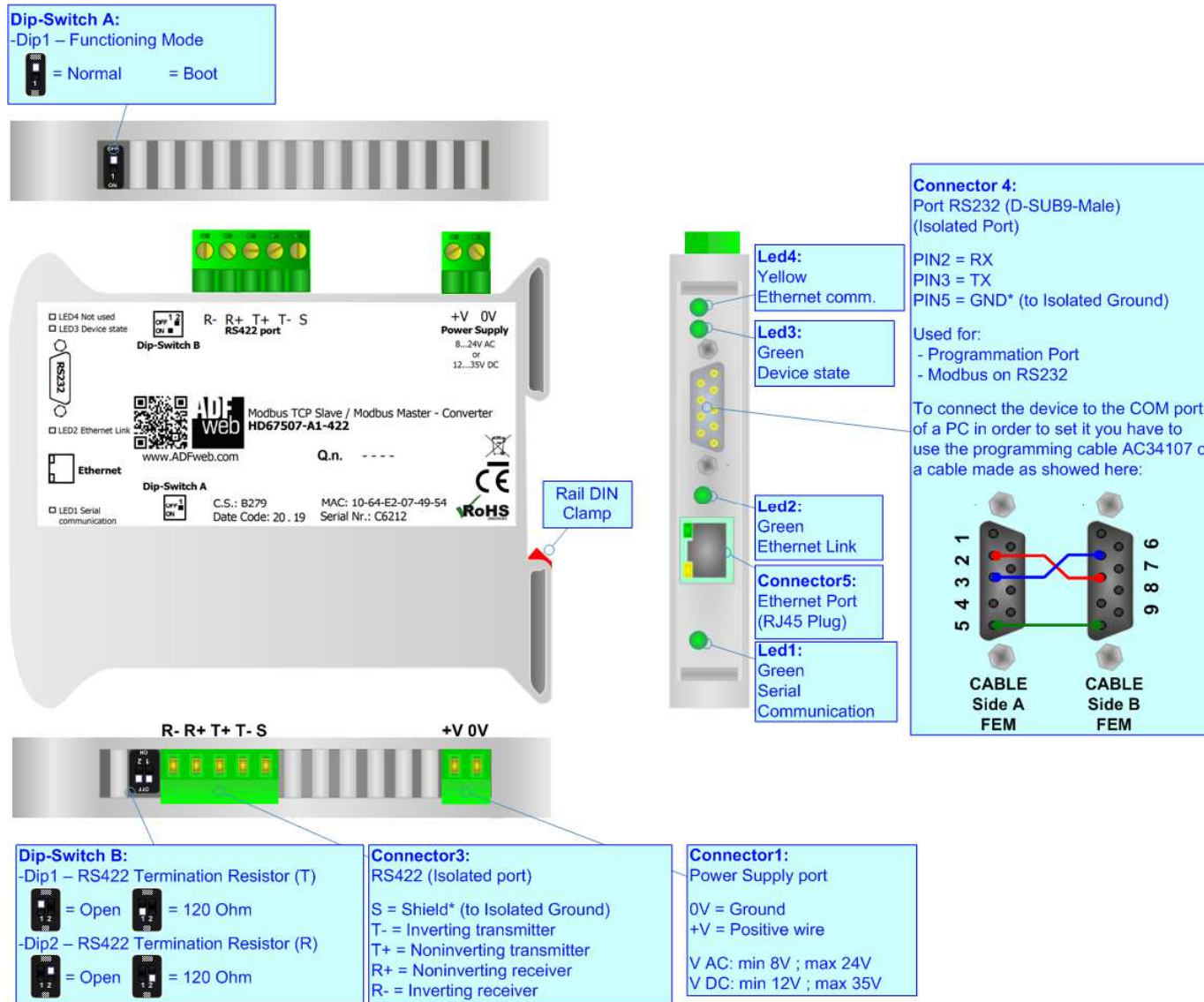

Figure 1b: Connection scheme for HD67507-A1-422

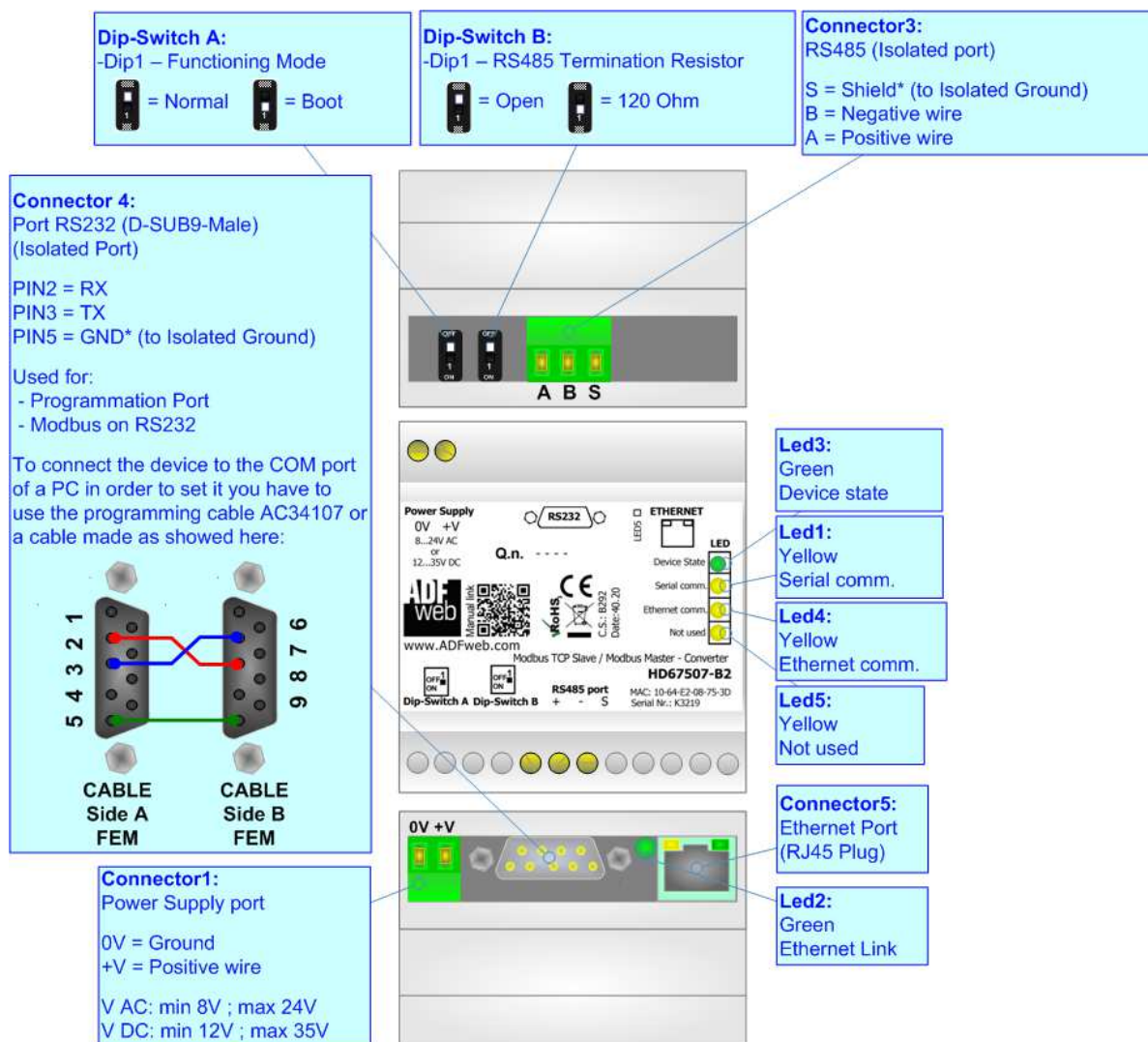

Figure 1c: Connection scheme for HD67507-B2

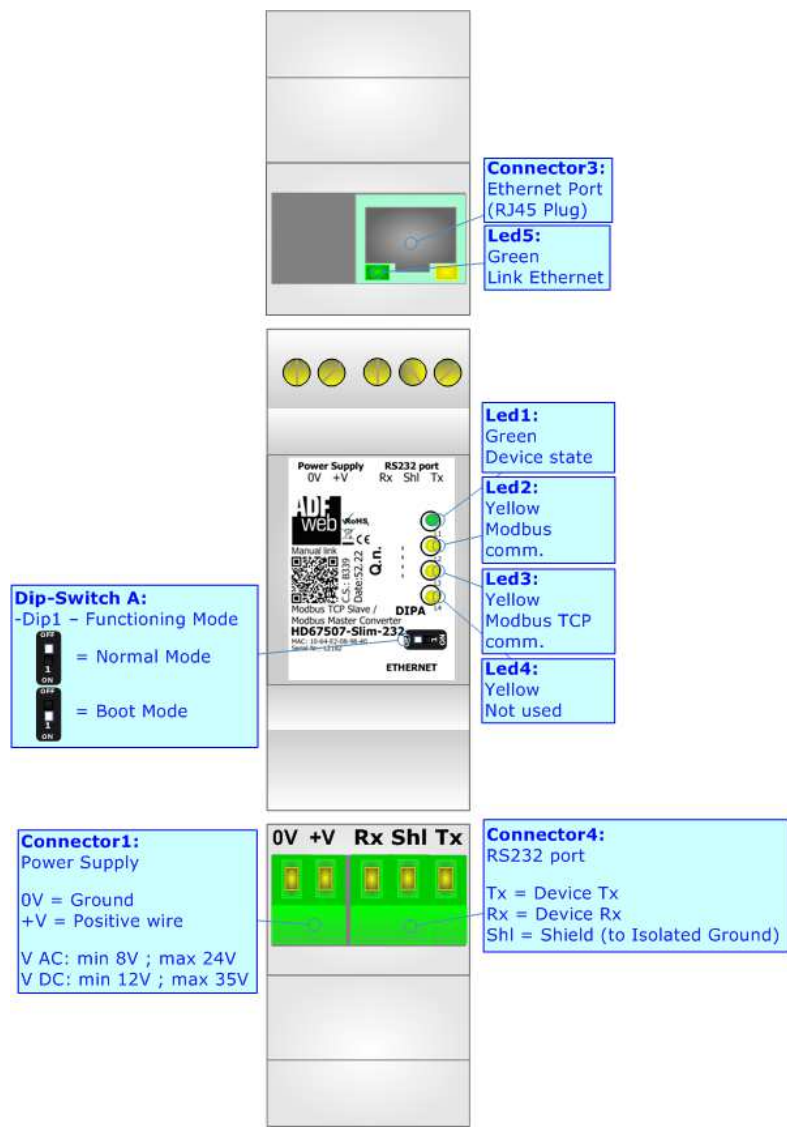

Figure 1d: Connection scheme for HD67507-Slim-232

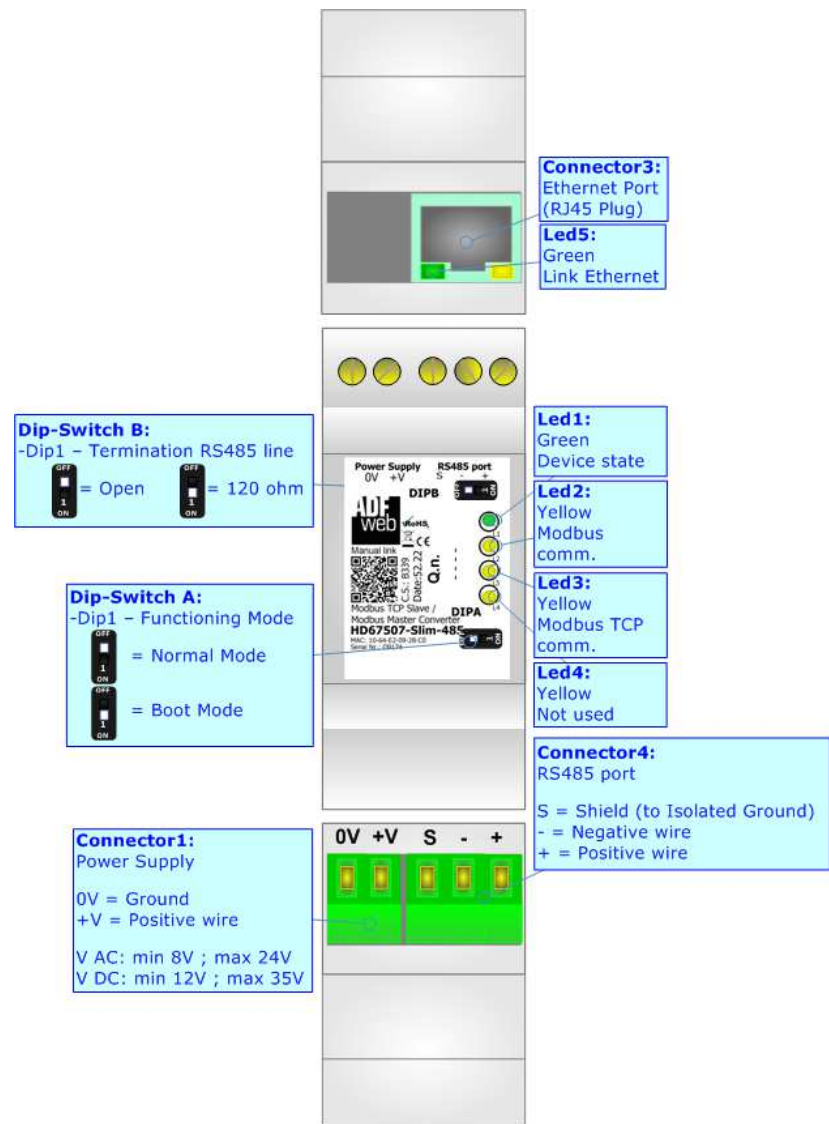

Figure 1e: Connection scheme for HD67507-Slim-485

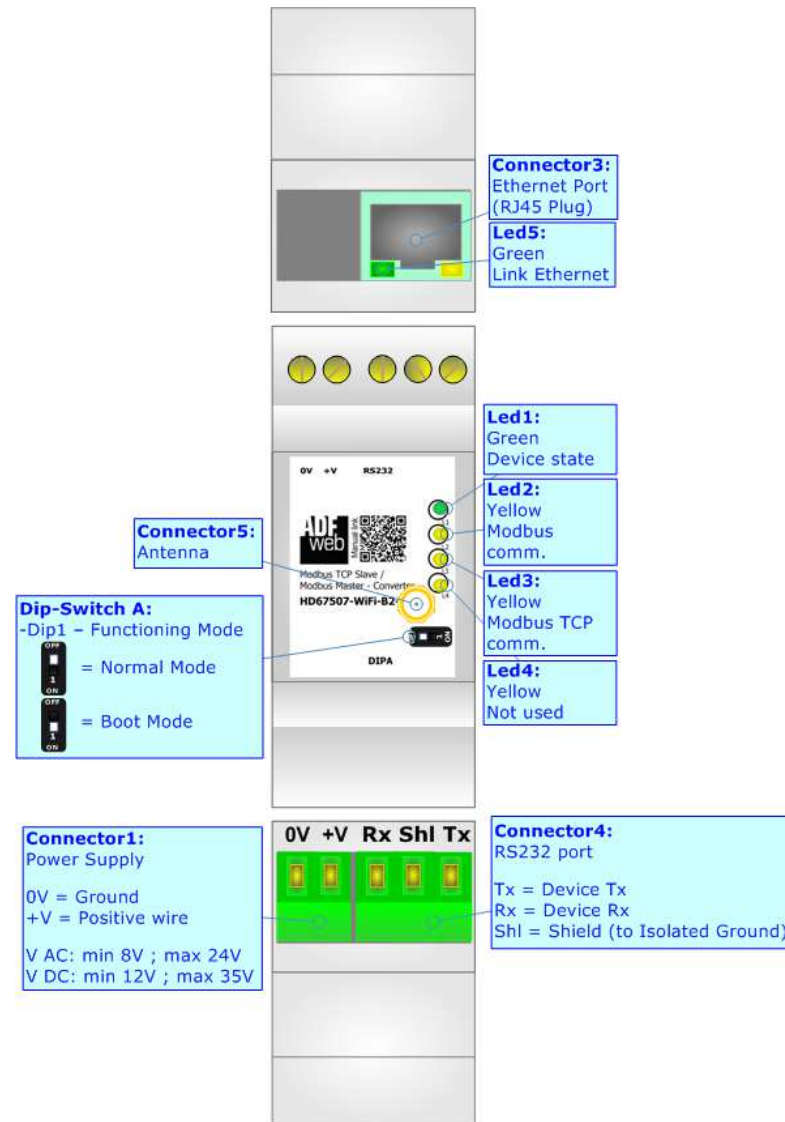

Figure 1f: Connection scheme for HD67507-WiFi-B2-232

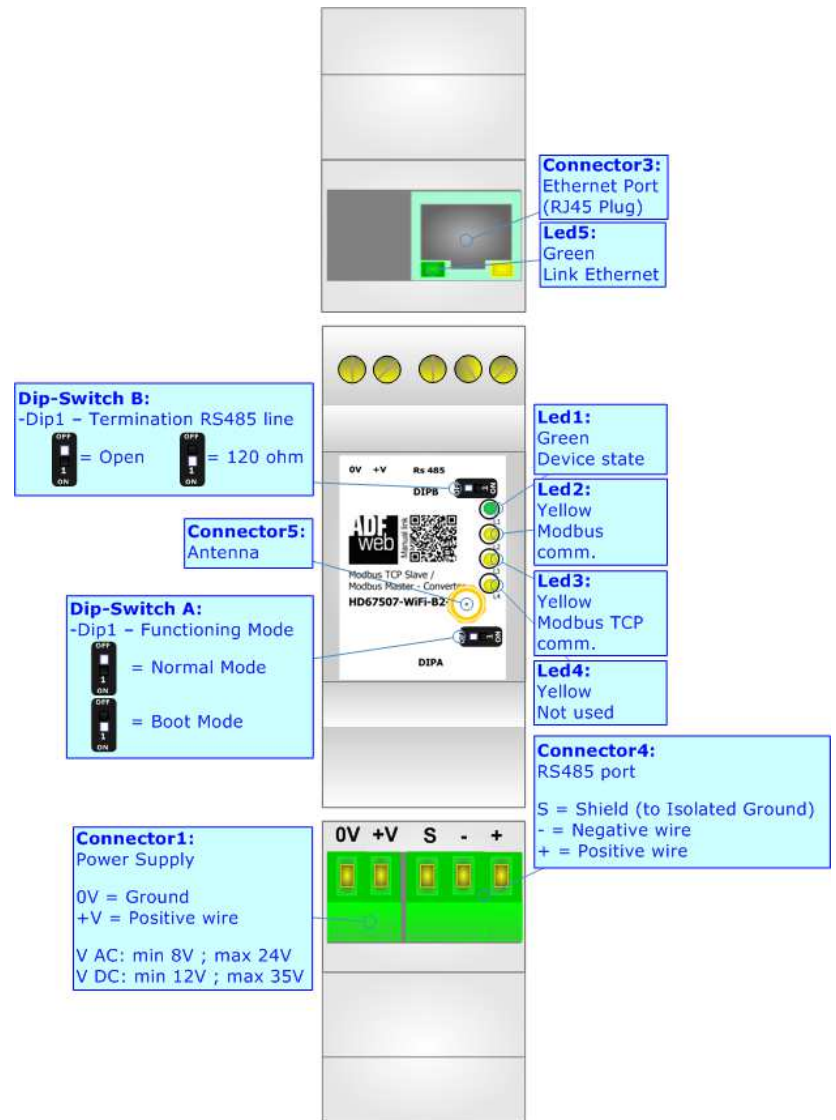

Figure 1g: Connection scheme for HD67507-WiFi-B2-485

CHARACTERISTICS:

The HD67507 is a Modbus TCP Slave / Modbus Master – Converter.

It allows for the following characteristics:

- Triple isolation between Serial - Power Supply, Serial - Ethernet, Power Supply - Ethernet.
- Ethernet 10Base-T / 100Base-T, autosensing for Modbus TCP;
- For Wi-Fi version, Access Point or Client mode ;
- Mountable on 35mm Rail DIN;
- Wide power supply input range: 8...24V AC or 12...35V DC;
- Wide temperature range: -40°C / 85°C [-40°F / +185°F].

This HD67507-A1/B2 is able to manage a maximum of ten simultaneous connections from Ethernet side.

It can be used in two operative ways:

- In the "**Routing Mode**" the command Modbus is forwarded on the serial line using the same requested addresses.
- In the "**NAT Mode**" the device addresses and data are altered through a translation table of the addresses.

CONFIGURATION:

You need Compositor SW67507 software on your PC in order to perform the following:

- Define the parameters of Modbus TCP line;
- Define the parameters of Modbus Serial line;
- Update the device.

POWER SUPPLY:

The devices can be powered at 8...24V AC and 12...35V DC. For more details see the two tables below.

VAC		VDC	
Vmin	Vmax	Vmin	Vmax
8V	24V	12V	35V

Consumption at 24V DC:

Device	Consumption [W/VA]
HD67507-A1	3.5
HD67507-A1-422	3.5
HD67507-B2	3.5
HD67507-Slim-xxx	3.5
HD67507-WiFi-B2-xxx	3.5

Caution: Not reverse the polarity power

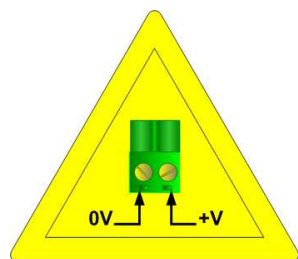

HD67507-A1
HD67507-A1-422

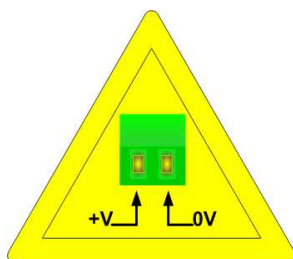

HD67507-B2
HD67507-Slim-xxx
HD67507-WiFi-B2

Connector1:
Power Supply port
0V = Ground
+V = Positive wire
V AC: min 8V ; max 24V
V DC: min 12V ; max 35V

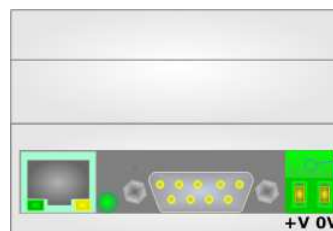
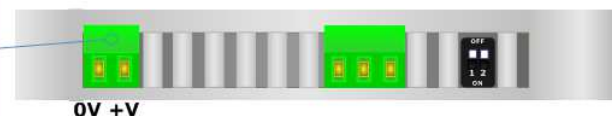

Connector1:
Power Supply port
0V = Ground
+V = Positive wire
V AC: min 8V ; max 24V
V DC: min 12V ; max 35V

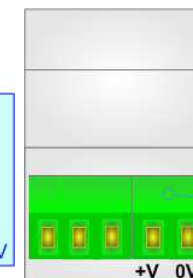

Connector1:
Power Supply
0V = Ground
+V = Positive wire
V AC: min 8V ; max 24V
V DC: min 12V ; max 35V

FUNCTION MODES:

The device has got two function modes depending on the position of the 'Dip1 of Dip-Switch A':

- The first, with 'Dip1 of Dip-Switch A' at "OFF" position, is used for the normal working of the device.
- The second, with 'Dip1 of Dip-Switch A' at "ON" position, is used for uploading the Project and/or Firmware.

For the operations to follow for the updating, see 'UPDATE DEVICE' section.

According to the functioning mode, the LEDs will have specific functions, see 'LEDS' section.

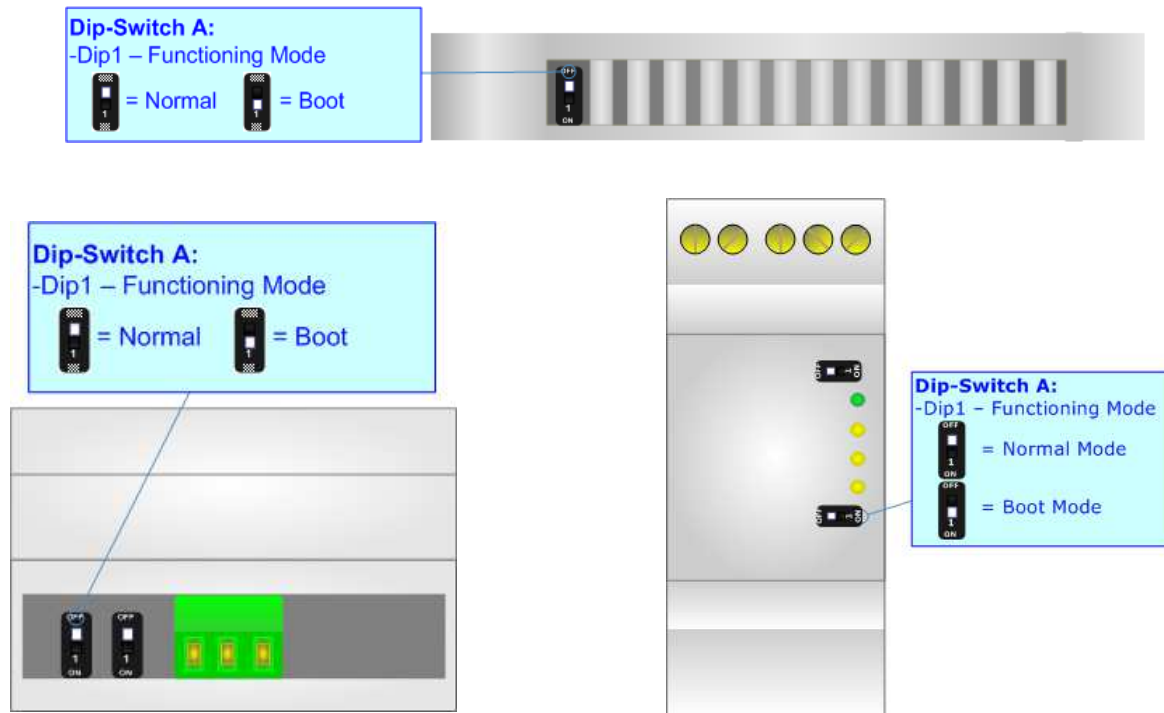

LEDS (for HD67507-A1 and HD67507-B2):

The devices has got four (five for HD67507-B2) LEDs that are used to give information of the functioning status. The various meanings of the LEDs are described in the table below.

LED	Normal Mode	Boot Mode
1: Serial Communication	Blinks when Modbus frame (RS232/RS485/RS422) are received	Blinks quickly: Boot state Blinks very slowly (~0.5Hz): update in progress
2: Ethernet Link	ON: Ethernet cable connected OFF: Ethernet cable disconnected	ON: Ethernet cable connected OFF: Ethernet cable disconnected
3: Device state	Blinks slowly (~1Hz)	Blinks quickly: Boot state Blinks very slowly (~0.5Hz): update in progress
4: Ethernet comm	Blinks when a Modbus TCP request is received	Blinks quickly: Boot state Blinks very slowly (~0.5Hz): update in progress
5: Not used (yellow) (Present only on HD67507-B2)	OFF	Blinks quickly: Boot state Blinks very slowly (~0.5Hz): update in progress

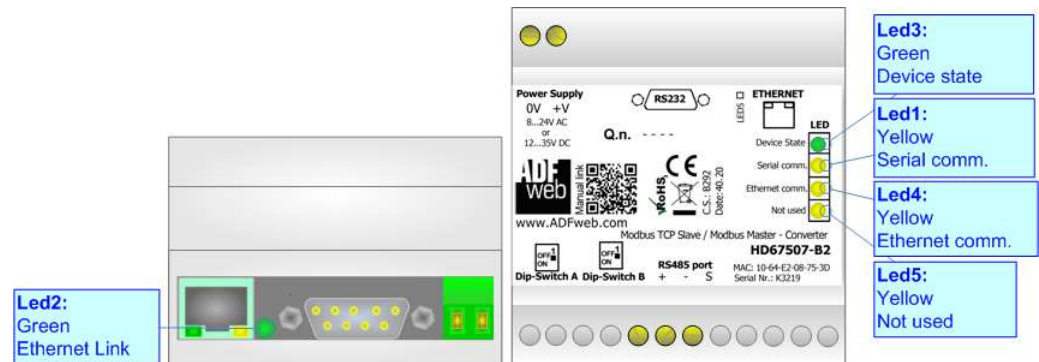
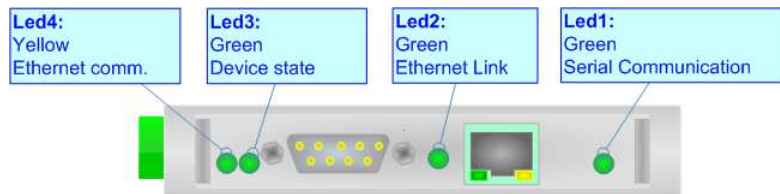

LEDS (for HD67507-Slim-xxx):

The devices has got five LEDs that are used to give information of the functioning status.
The various meanings of the LEDs are described in the table below.

LED	Normal Mode	Boot Mode
1: Device state	Blinks slowly (~1Hz)	Blinks quickly: Boot state Blinks very slowly (~0.5Hz): update in progress
2: Modbus comm.	Blinks when Modbus frame (RS232/RS485) are received	Blinks quickly: Boot state Blinks very slowly (~0.5Hz): update in progress
3: Modbus TCP comm.	Blinks when a Modbus TCP request is received	Blinks quickly: Boot state Blinks very slowly (~0.5Hz): update in progress
4: Not used	OFF	Blinks quickly: Boot state Blinks very slowly (~0.5Hz): update in progress
5: Ethernet Link	ON: Ethernet cable connected OFF: Ethernet cable disconnected	ON: Ethernet cable connected OFF: Ethernet cable disconnected

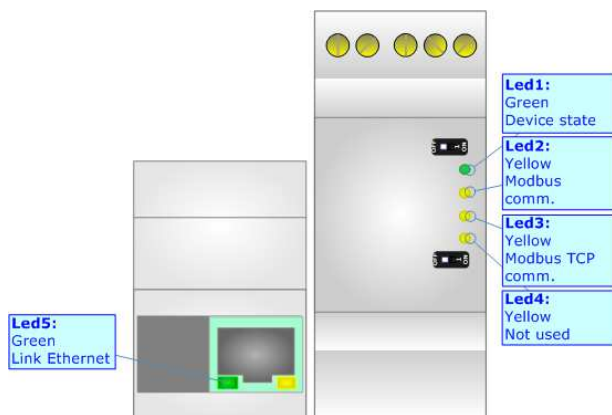

LEDS (for HD67507-WiFi-B2):

The devices has got five LEDs that are used to give information of the functioning status.
The various meanings of the LEDs are described in the table below.

LED	Normal Mode	Boot Mode
1: Device state	Blinks slowly (~1Hz)	Blinks quickly: Boot state Blinks very slowly (~0.5Hz): update in progress
2: Modbus comm.	Blinks when Modbus frame (RS232/RS485) are received	Blinks quickly: Boot state Blinks very slowly (~0.5Hz): update in progress
3: Modbus TCP comm.	Blinks when a Modbus TCP request is received	Blinks quickly: Boot state Blinks very slowly (~0.5Hz): update in progress
4: Not used	OFF	Blinks quickly: Boot state Blinks very slowly (~0.5Hz): update in progress
5: Ethernet Link	ON: Ethernet cable connected OFF: Ethernet cable disconnected	ON: Ethernet cable connected OFF: Ethernet cable disconnected

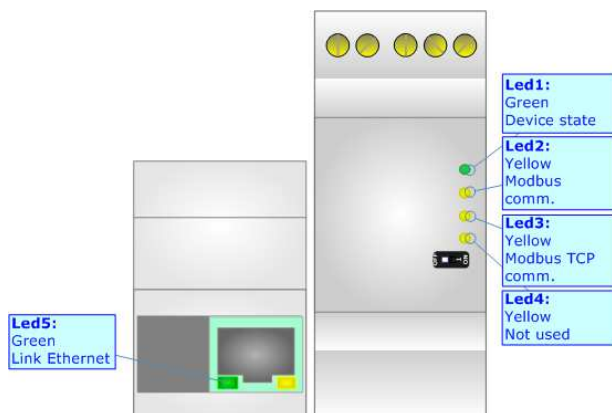

ETHERNET:

The Ethernet connection must be made using Connector2/3/5 of HD67507 with at least a Category 5E cable. The maximum length of the cable should not exceed 100m. The cable has to conform to the T568 norms relative to connections in cat.5 up to 100 Mbps. To connect the device to a Hub/Switch the use of a straight cable is recommended. To connect the device to a PC/PLC/other the use of a cross cable is recommended.

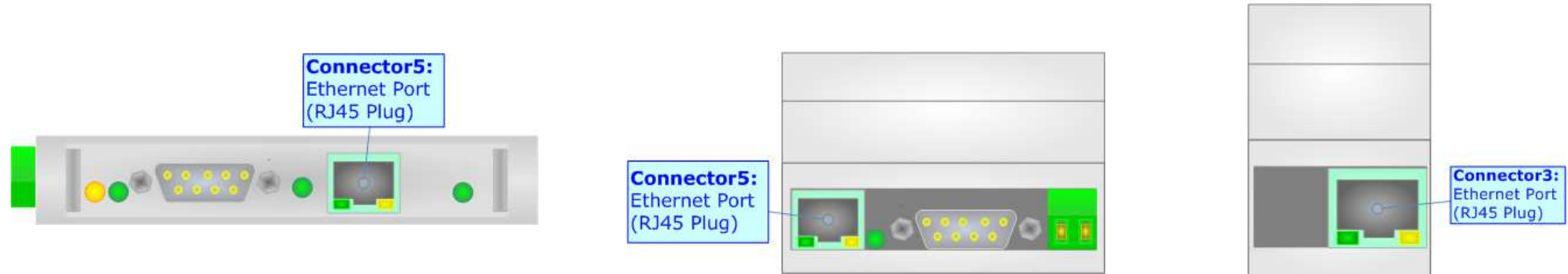

Wi-Fi (for HD67507-WiFi-B2):

The HD67507-WiFi-B2 can be configured as Wi-Fi Access Point or Wi-Fi Client. It supports DHCP functions. The type of Wi-Fi used is the 802.11b/g/n and it supports different type of security protocol: WEP, WPA, WPA2 and none. The antenna is integrated in the hardware, so any external antenna is ned.

RS232:

The connection from RS232 socket to a serial port (example one from a personal computer) must be made with a Null Modem cable (a serial cable where the pins 2 and 3 are crossed).

It is recommended that the RS232 cable not exceed 15 meters.

The HD67507-A1/B2 is provided with a D-sub connector type DE-9 Male (also called DB-9). The cable must use a DE-9 Female connector. The serial port is used for programming the device and for Modbus communication.

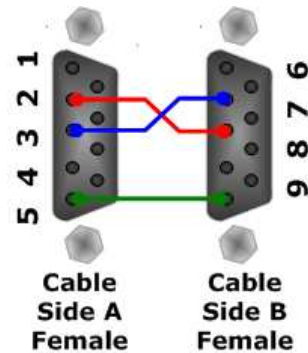

The HD67507-Slim-232 and HD67507-WiFi-B2-232 is provided with a 3way 5mm removable screw terminal. The serial port is used for Modbus communication.

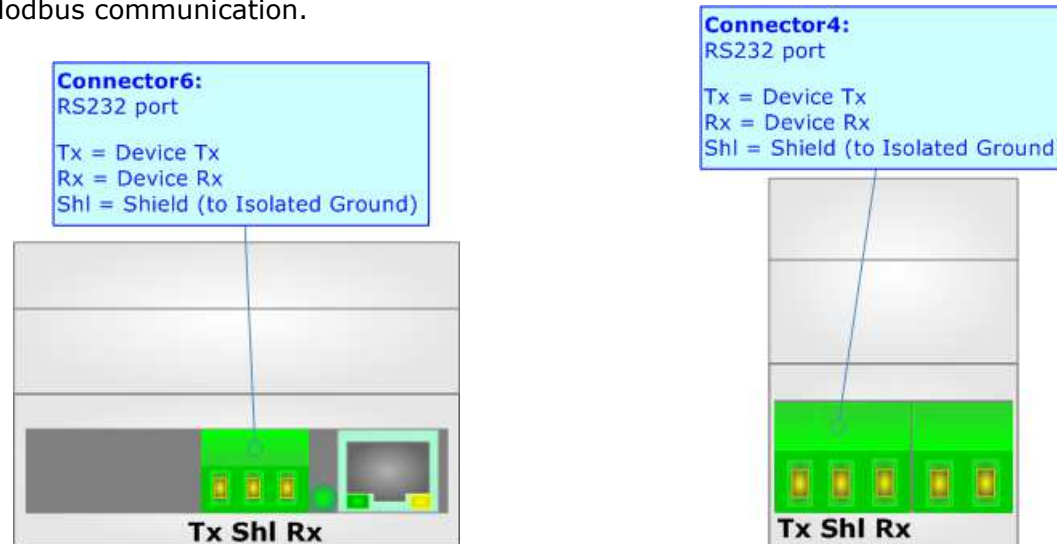

RS485:

To terminate the RS485 line with a 120Ω resistor, it is necessary to put dip 1 ON, like in figure.

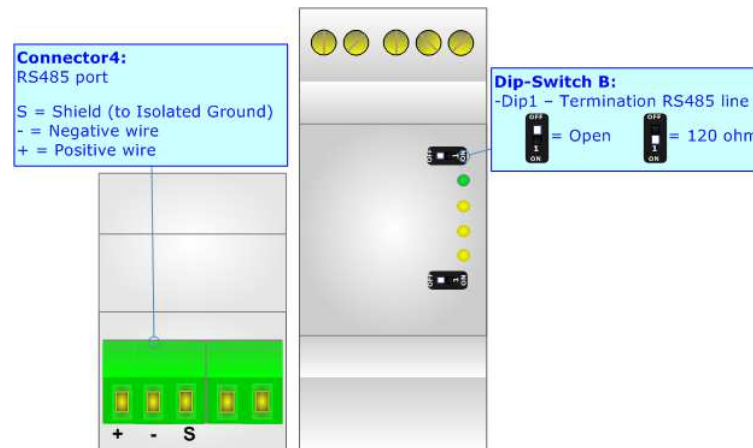
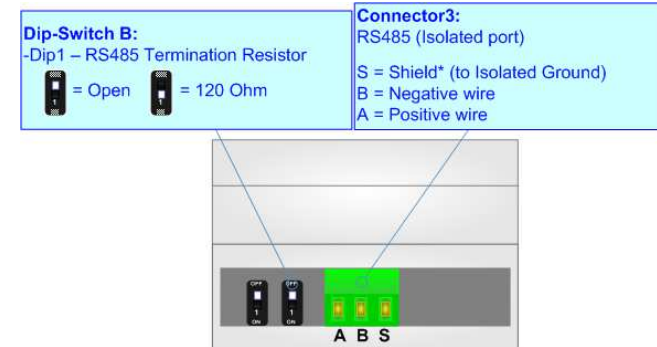
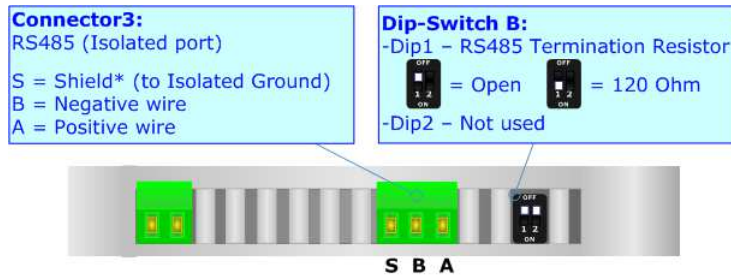

The maximum length of the cable should be 1200m (4000 feet).

Here some codes of cables:

- Belden: p/n 8132 - 2x 28AWG stranded twisted pairs conductor + foil shield + braid shield;
- Belden p/n 82842 - 2x 24AWG stranded twisted pairs conductor + foil shield + braid shield;
- Tasker: p/n C521 - 1x 24AWG twisted pair conductor + foil shield + braid shield;
- Tasker: p/n C522 - 2x 24AWG twisted pairs conductor + foil shield + braid shield.

RS422:

For terminating the RS422 line with a 220Ω resistor it is necessary to put ON dip 1 for T line and/or put ON dip 2 for R line, like in figure.

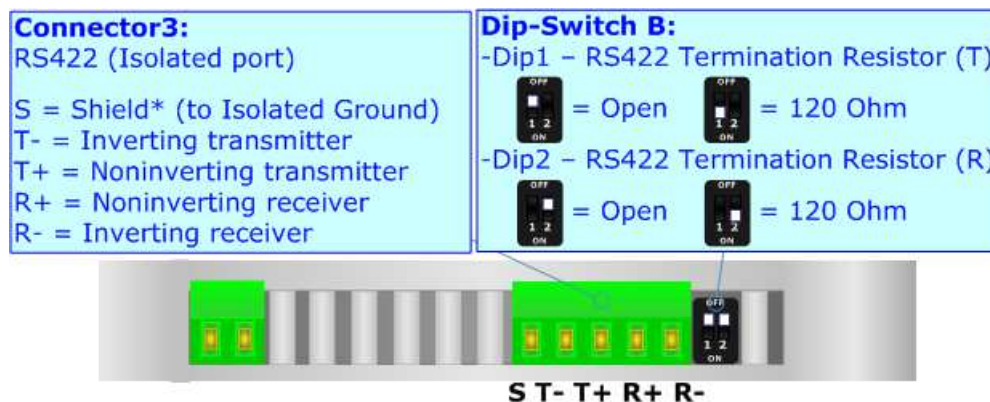

The maximum length of the cable should be 1200m (4000 feet).

USE OF COMPOSITOR SW67507:

To configure the Converter, use the available software that runs with Windows called SW67507. It is downloadable on the site www.adfweb.com and its operation is described in this document. *(This manual is referenced to the last version of the software present on our web site)*. The software works with MSWindows (XP, Vista, Seven, 8, 10, 11; 32/64bit).

When launching the SW67507, the window below appears (Fig. 2).



Note:

It is necessary to have installed .Net Framework 4.

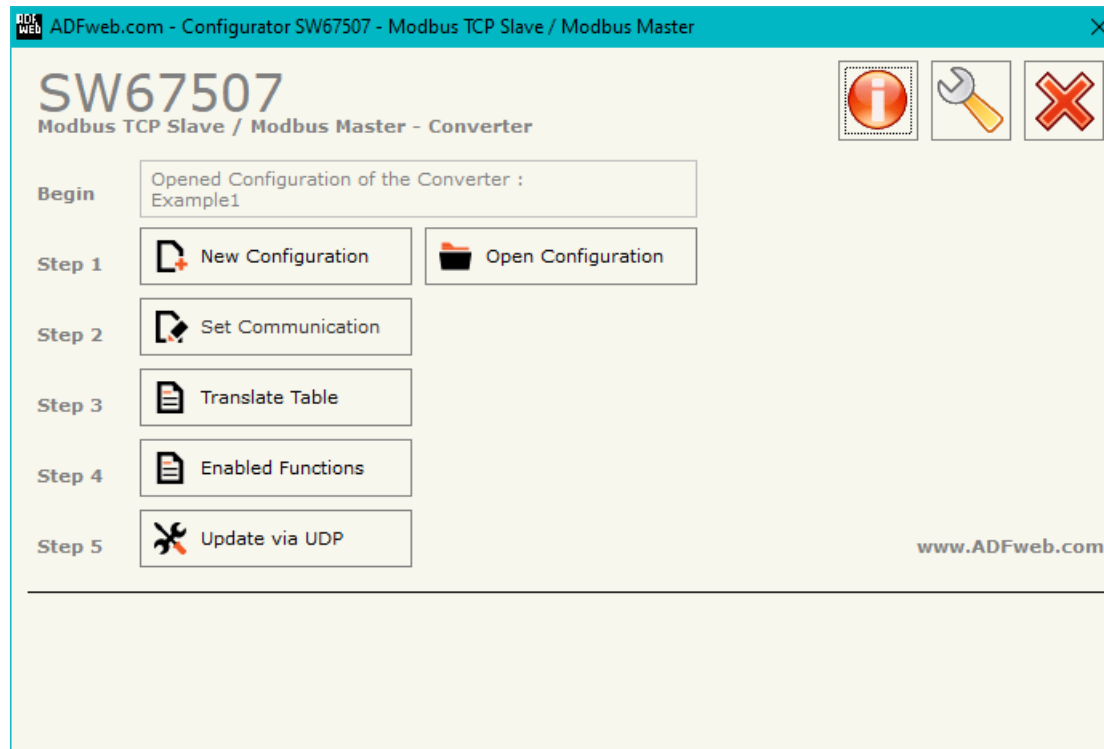
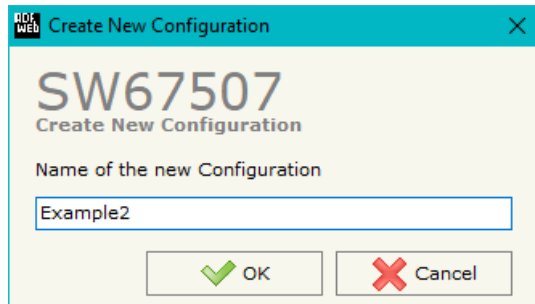

Figure 2: Main window for SW67507

NEW CONFIGURATION / OPEN CONFIGURATION:

The “**New Configuration**” button creates the folder which contains the entire device’s configuration.



A device’s configuration can also be imported or exported:

- To clone the configurations of a programmable “Modbus TCP Slave / Modbus Master - Converter” in order to configure another device in the same manner, it is necessary to maintain the folder and all its contents;
- To clone a project in order to obtain a different version of the project, it is sufficient to duplicate the project folder with another name and open the new folder with the button “**Open Configuration**”.

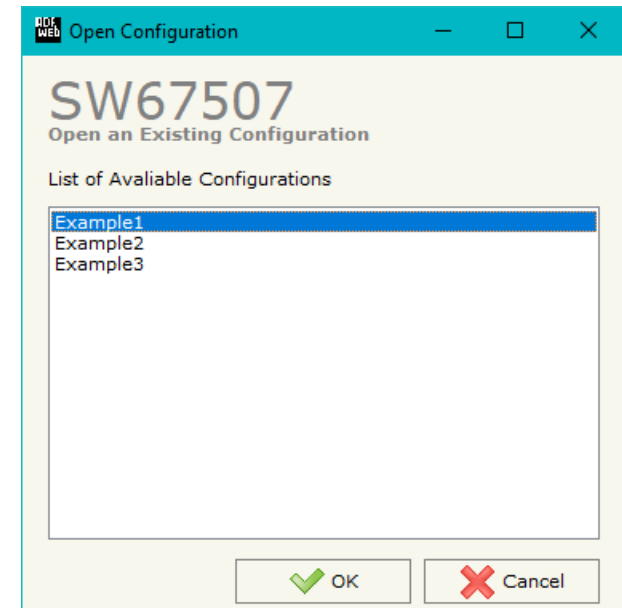

SOFTWARE OPTIONS:

By pressing the “**Settings**” () button there is the possibility to change the language of the software and check the updatings for the compositor.

In the section “Language” it is possible to change the language of the software.

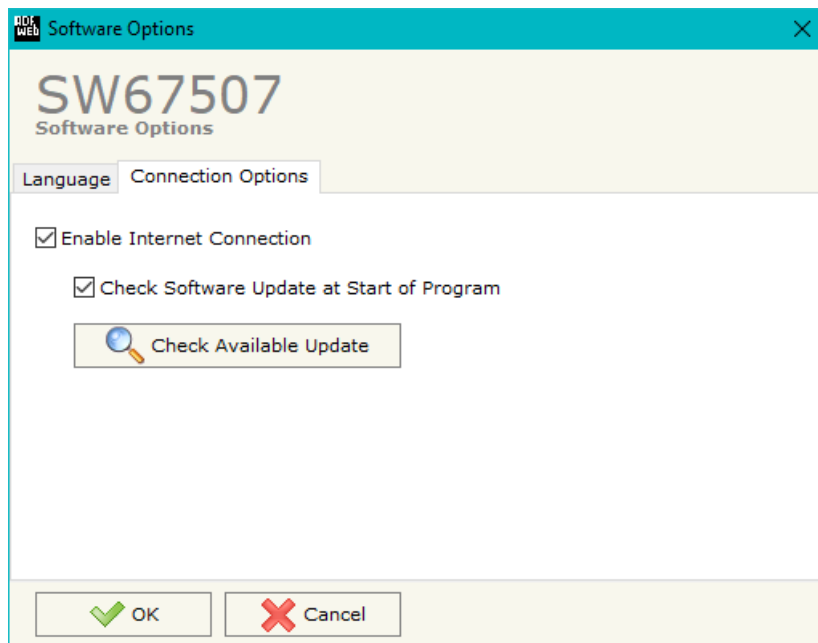

In the section “Connection Options”, it is possible to check if there are some updatings of the software compositor in ADFweb.com website. Checking the option “**Check Software Update at Start of Program**”, the SW67507 check automatically if there are updatings when it is launched.

SET COMMUNICATION:

By Pressing the “**Set Communication**” button from the main window for SW67507 (Fig. 2) the window “Set Communication” appears (Fig. 3).

The window is divided in different sections in order to define the different parameters of the converter:

- Select Device
- Ethernet Connection
- Operation Mode
- Modbus Master
- Modbus TCP Slave
- Wi-Fi

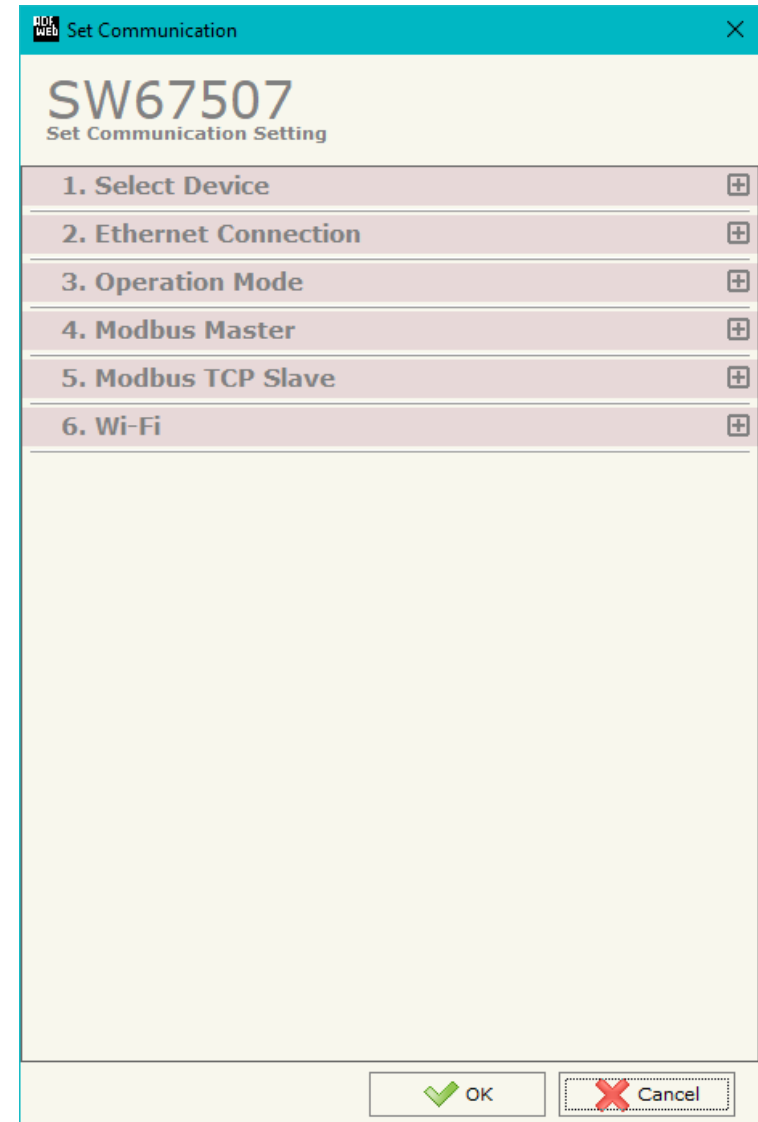

Figure 3a: “Set Communication” window

SELECT DEVICE:

In the section "Select Device" it is possible to select the type of converter used:

- HD67507 (Modbus TCP on Ethernet);
- HD67507-WiFi (Modbus TCP on Ethernet and Wi-Fi).

ETHERNET CONNECTION:

The means of the fields for "Ethernet Connection" are:

- In the field "**Device Name (Hostname)**" the Hostname to assign to the converter is defined;
- If the field "**Obtain an IP Address Automatically (DHCP for Cable Connection)**" is checked, DHCP for LAN connection is enabled;
- If the field "**Obtain an IP Address Automatically (DHCP for Wi-Fi Connection)**" is checked, DHCP for Wi-Fi connection is enabled;
- If the field "**Enable DNS**" is checked, DNS protocol is enabled;
- In the field "**Primary DNS**" the IP Address of the primary DNS server is defined;
- In the field "**Secondary DNS**" the IP Address of the secondary DNS server is defined.

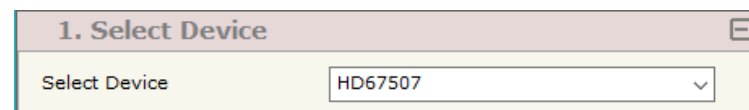

Figure 3b: "Set Communication → Working Mode" window

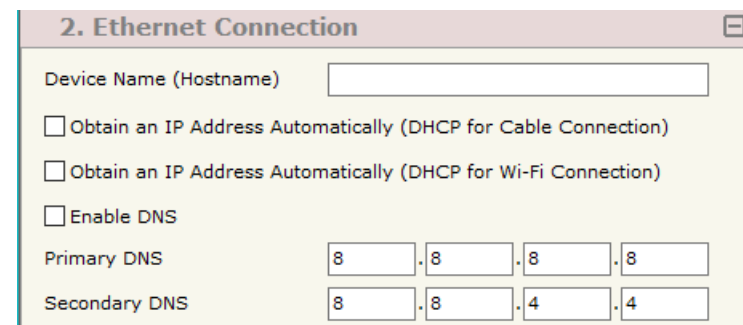

Figure 3c: "Set Communication → Ethernet Connection" window

OPERATION MODE:

In the section "Operation Mode" it is possible to define the working mode of the converter (see page 33 for more info):

- Routing Mode;
- NAT Mode.

MODBUS MASTER:

This section is used to define the main parameters of Modbus line. The means of the fields are:

- In the field "**Serial**" the serial port to use is defined;
- In the field "**Baudrate**" the baudrate for the serial line is defined;
- In the field "**Parity**" the parity of the serial line is defined;
- In the field "**Stop Bits**" the number of Stop Bits of the serial line is defined;
- In the field "**TimeOut (ms)**" the maximum time that the converter attends for the answer from the Slave interrogated is defined;
- In the field "**Communication Idel Time (ms)**" the delay (idle time) between two Modbus requests is defined;
- In the field "**Time Between Bytes (ms)**" a custom delay between the bytes is defined;
- If the field "**Modbus Filter**" is checked, the filter for the not Modbus frames is defined;

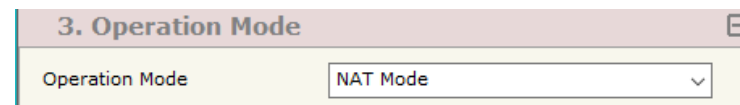

Figure 3c: "Set Communication → Operation Mode" window

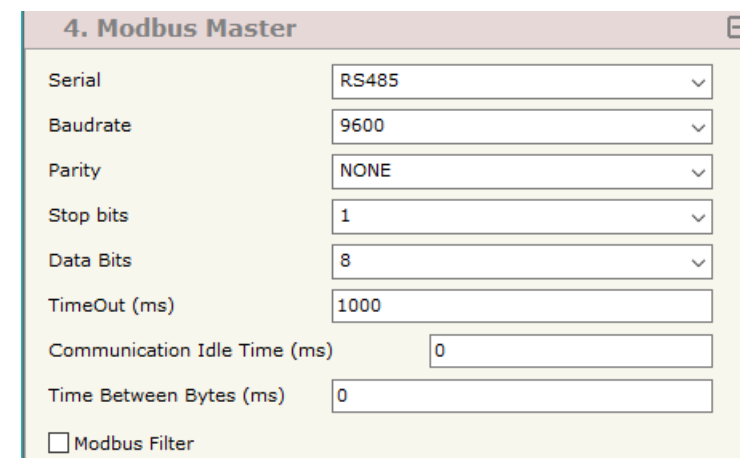
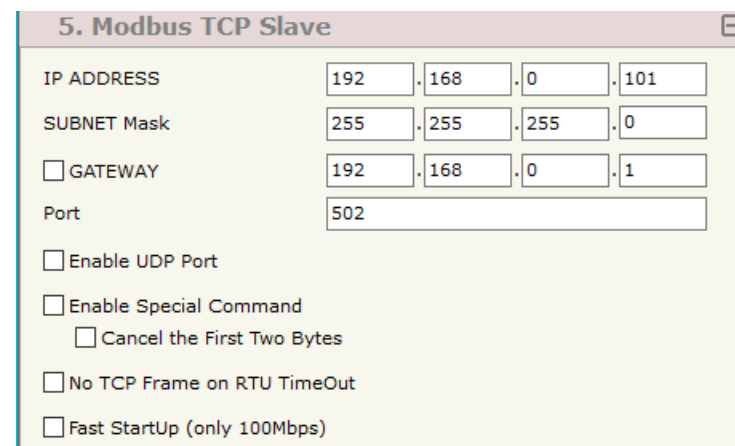

Figure 3d: "Set Communication → Modbus Master" window

MODBUS TCP SLAVE:

This section is used to define the general parameters of Modbus TCP. The means of the fields are:

- In the field "**IP Address**" the IP address of the converter is defined;
- In the field "**SubNet Mask**" the Subnet Mask of the converter is defined;
- In the field "**Gateway**" the default gateway of the net is defined. This feature can be enabled or disabled pressing the Check Box field. This feature is used for going out of the net;
- In the field "**Port**" the port used for Modbus TCP communication is defined;
- Checking "**Enable UDP Port**" field it is possible to do a Broadcast request. This request must be made at Port 64223 (\$FADF) with these six byte of data: \$53, \$45, \$41, \$52, \$43, \$48. Each device in response sends a total of 10 Bytes. These bytes are four for the IP and the other for the MAC address (Example of response: 0xC0, 0xA8, 0x01, 0x2A, 0x11, 0x22, 0x33, 0x44, 0x55, 0x58. So the IP is: 192.168.1.42; and the MAC Address: 11-22-33-44-55-58);
- If the field "**Enable Special Command**" is checked, it is possible to send a no-Modbus request through the Converter. i.e. a TCP frame with the first two characters 0x55 and 0xAA is sent in the Modbus RTU line as is. If you don't want to send the first two bytes (0x55, 0xAA) in the RTU line it is possible to check the field "**Cancel the first two bytes**";
- If the field "**No TCP frame on RTU Timeout**" is checked, the Converter don't sends back the reply on TCP (error response) if the Slave RTU interrogated has not replied.
- If the field "**Fast StartUp (only 100Mb/s)**" is checked, the Converter take less time to go online. This command can use only if the Converter is used in a 100Mb/s network;



5. Modbus TCP Slave				
IP ADDRESS	192	.168	.0	.101
SUBNET Mask	255	.255	.255	.0
<input type="checkbox"/> GATEWAY	192	.168	.0	.1
Port	502			
<input type="checkbox"/> Enable UDP Port				
<input type="checkbox"/> Enable Special Command				
<input type="checkbox"/> Cancel the First Two Bytes				
<input type="checkbox"/> No TCP Frame on RTU TimeOut				
<input type="checkbox"/> Fast StartUp (only 100Mbps)				

Figure 3e: "Set Communication → Modbus TCP Slave" window

Wi-Fi:

This section is used to define the general parameters of Wi-Fi. It is possible to defined the type of Wi-Fi communication:

- Access Point;
- Client.

The means of the fields for Access Point configuration are:

- In the field "**IP Address**" the IP address of the converter is defined;
- In the field "**Subnet Mask**" the SubNet Mask of the converter is defined;
- In the field "**GATEWAY**" the default gateway of the net is defined. This feature can be enabled or disabled pressing the Check Box field. This feature is used for going out of the net;
- In the field "**SSID**" the name of the Wi-Fi network to create is defined;
- In the field "**Password**" the password used for Wi-Fi connection is defined;
- In the field "**Type**" the type of security protocol used by the Wi-Fi network is defined;
- If the field "**Enable DHCP**" is checked, the converter acts as DHCP Server for the Clients connected. If the option is enabled, in the fields "**DHCP First IP Address**" and "**DHCP SUBNET Mask**" the IP Addresses range used for DHCP is defined. In the field "**Lease Time (seconds)**" the required time for the renewing of the IP Address assigned to the Client is defined;
- In the field "**Max Client**" the maximum number of Wi-Fi Clients accepted is defined;
- In the field "**Channel**" the channel for Wi-Fi communication is defined.

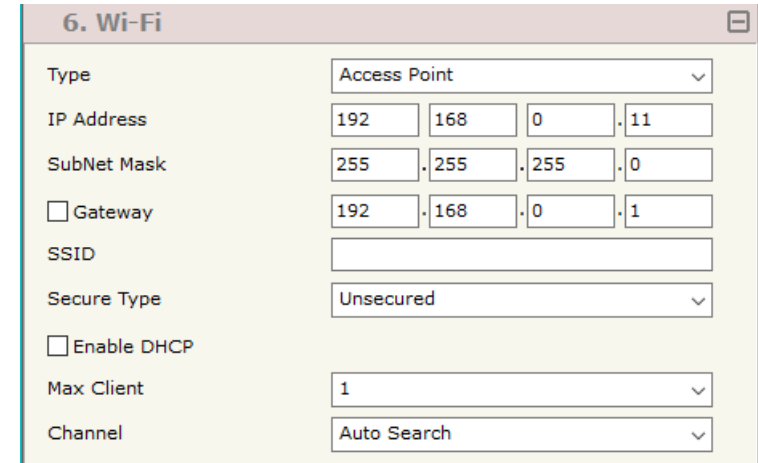

Figure 3f: "Set Communication → Wi-Fi" window

The means of the fields for Client configuration are:

- If the field "**Obtain an IP Address automatically**" is checked, the converter gets the IP Address using DHCP. Otherwise, the IP Address is defined as static;
- In the field "**IP Address**" the IP address of the converter is defined;
- In the field "**Subnet Mask**" the SubNet Mask of the converter is defined;
- In the field "**GATEWAY**" the default gateway of the net is defined. This feature can be enabled or disabled pressing the Check Box field. This feature is used for going out of the net;
- In the field "**SSID**" the name of the Wi-Fi network to connect is defined;
- In the field "**Password**" the password used to connect to the Wi-Fi network is defined.

Type	Station			
IP Address	192	168	0	.11
SubNet Mask	255	.255	.255	.0
<input type="checkbox"/> Gateway	192	.168	.0	.1
SSID				
Password				

Figure 3g: "Set Communication → Wi-Fi" window

The means of the fields for “Modbus TCP Slave on Wi-Fi” for Client configuration are:

- ➔ If the field “**Obtain an IP Address automatically**” is checked, the converter gets the IP Address using DHCP. Otherwise, the IP Address is defined as static;
- ➔ In the field “**IP Address**” the IP address of Modbus TCP side of the converter is defined;
- ➔ In the field “**Subnet Mask**” the SubNet Mask of Modbus TCP side of the converter is defined;
- ➔ In the fields “**GATEWAY**” the default gateway of the net is defined. This feature can be enabled or disabled pressing the Check Box field. This feature is used for going out of the net;
- ➔ In the field “**Port**” the port used for Modbus TCP communication is defined;
- ➔ In the field “**SSID**” the name of the Wi-Fi network to connect is defined;
- ➔ In the field “**Password**” the password used to connect to the Wi-Fi network is defined;
- ➔ In the field “**Name**”, the host name for the Wi-Fi node is defined (only for DHCP).

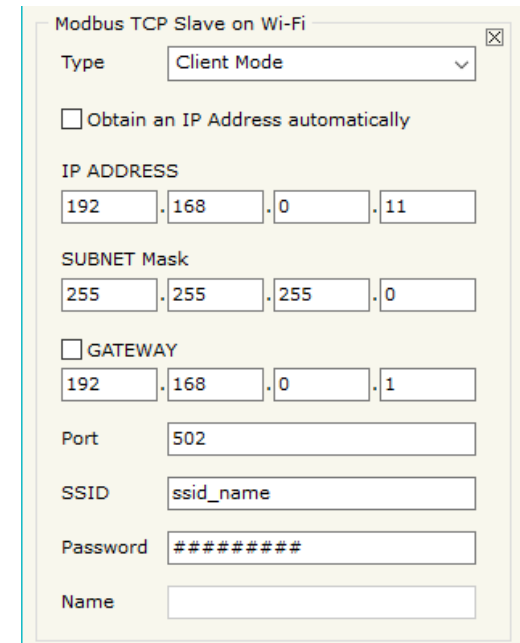

Figure 3d: “Set Communication” window

OPERATION MODE:**ROUTING:**

A few characteristics of the Modbus RTU package have been modified in the standard of the Modbus TCP protocol. Two bytes of the final CRC were eliminated (no longer necessary for the information to reach its already corrected destination). The first byte of the slave identification was changed, leaving the one that is called PDU. A frame denominated as MBAP header with dimensions of 7 bytes was added to the head of the PDU.

It is composed by the following:

- Word transaction identifier (recopied from the slave in the response phase);
- Word protocol identifier (0=Modbus protocol);
- Word length (number of successive bytes);
- Byte unit identifier (used for the routing operation).

By using the last byte of the MBAP header, it is possible to carry out the routing from a requested Modbus TCP toward a serial line using the address from the slave which is specified by the byte unit identifier.

Example:

A requested Modbus TCP made in the device as the address 192.168.0.200 for the holding register address \$2000, which is MBAP unit identifier has the value of 2. It will be followed by the request on the serial for the device with the address 2 at the word \$2000.

After the request is made, the RTU will respond. The master TCP will be given the same response which will be reconstructed according to the specifications of the Modbus TCP.

If the RTU slave responds with an exception, that exception code will be transmitted again to the TCP master. If the RTU slave does not respond in the estimated time defined by the Timeout parameter, an exception response will be given: error code \$0B.

NATTING:

When NAT operation mode is used, the requested data will be processed through a table of translations of the Modbus network addresses.

TRANSLATE TABLE:

Within the section "Translate Table" it is possible to define the variables that can be read or written by the TCP bus on the RTU bus when the device is in NAT mode.

By pressing the "Translate Table" button from the main window for SW67507 (Fig. 2), the window "Set Translate Table" appears (Fig. 4).

The data of the columns have the following meanings:

- In the field "Data Type" the type of data for the Modbus translation is defined;
- In the field "Slave ID TCP" the address of the virtual Modbus TCP node is defined;
- In the field "Address TCP" the Modbus Address of the virtual TCP node is defined;
- In the field "Slave ID" the ID of the Modbus slave to poll is defined;
- In the field "Address" the Modbus address of the data on the RTU device is defined;
- In the field "NPoint" the number of consecutive registers to read/write is defined;
- In the field "Mnemonic" a brief description is defined.

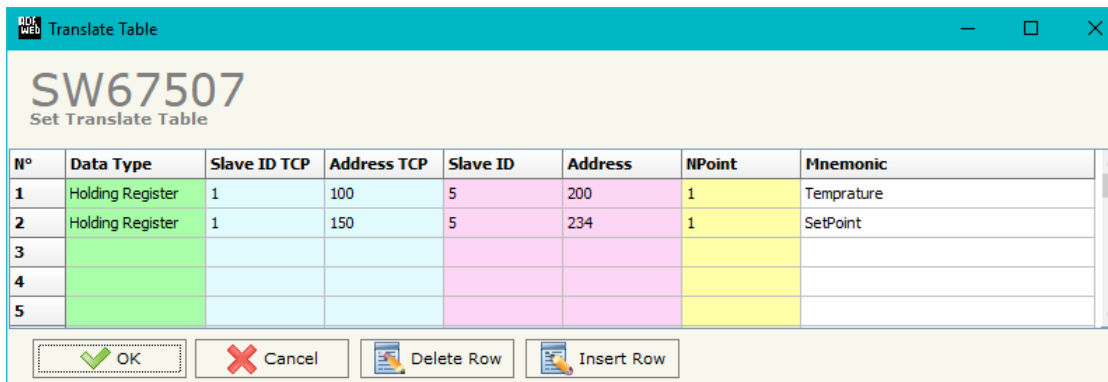

Figure 4: "Set Translate Table" window

Example 1:

If you want, from TCP network, write a data it the RTU network on the device at:

- Address 5;
- Through Gateway WORD 100 (Address RTU);
- Address TCP 1000.

In the above scenario:

Specify the type of data between:

- Coil Status (bit in read write);
- Input Status (bit in read);
- Holding Register (word in read and write);
- Input Register (word in read).

From the side of the MODBUS TCP:

- Address of data to read.

From the side of the MODBUS RTU:

- Address of the device to interrogate;
- Address of data to read on device.

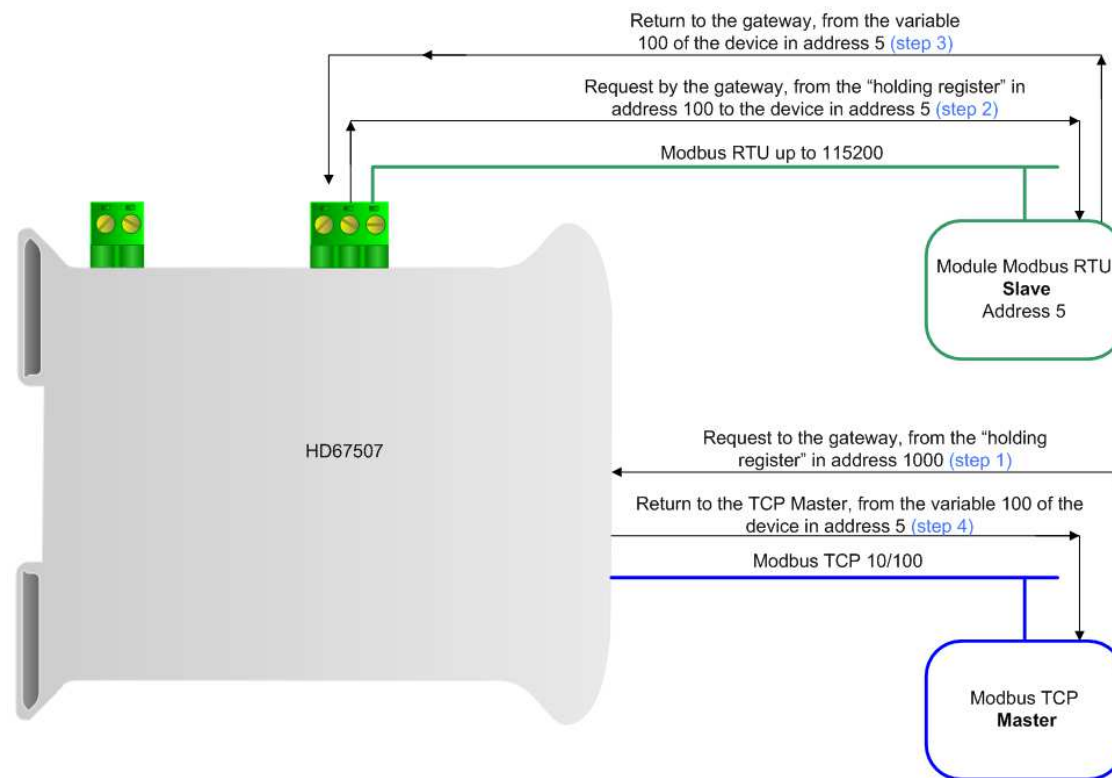

Note: If the RTU slave responds with an exception, that exception code will be transmitted to the TCP Master. If the RTU slave does not respond within the estimated time defined by the Timeout parameter, an exception response will be given on TCP side: error code \$0B.

UPDATE DEVICE:

By pressing the “**Update Device**” button, it is possible to load the created Configuration into the device; and also the Firmware, if necessary.

If you don’t know the actual IP address of the device you have to use this procedure:

- Turn OFF the Device;
- Put Dip2 of `Dip-Switch A` in ON position;
- Turn ON the device
- Connect the Ethernet cable;
- Insert the IP “**192.168.2.205**”;
- Press the “**Ping**” button, “Device Found! must appear”;
- Press the “**Next**” button;
- Select which operations you want to do;
- Press the “**Execute update firmware**” button to start the upload;
- When all the operations are “OK” turn OFF the Device;
- Put Dip2 of `Dip-Switch A` in OFF position;
- Turn ON the device.

At this point the configuration/firmware on the device is correctly updated.

If you know the actual IP address of the device, you have to use this procedure:

- Turn on the Device with the Ethernet cable inserted;
- Insert the actual IP of the Converter;
- Press the “**Ping**” button, must appear “Device Found!”;
- Press the “**Next**” button;
- Select which operations you want to do;
- Press the “**Execute update firmware**” button to start the upload;
- When all the operations are “OK” the device automatically goes at Normal Mode.

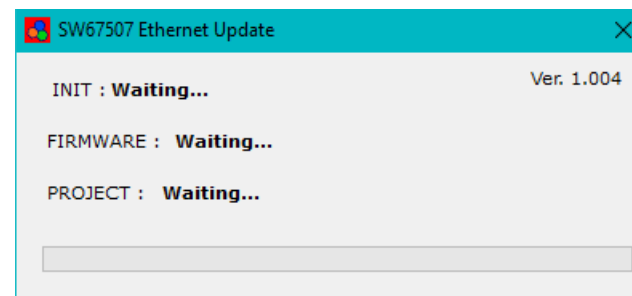
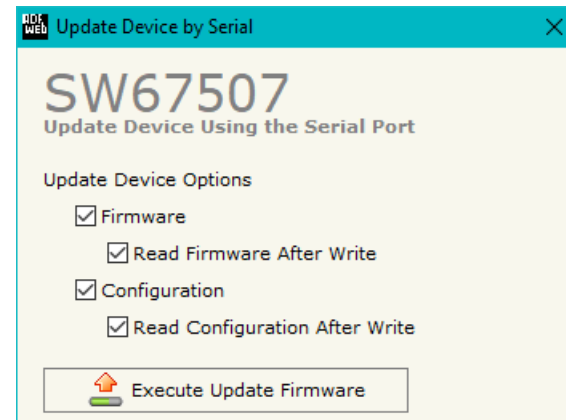
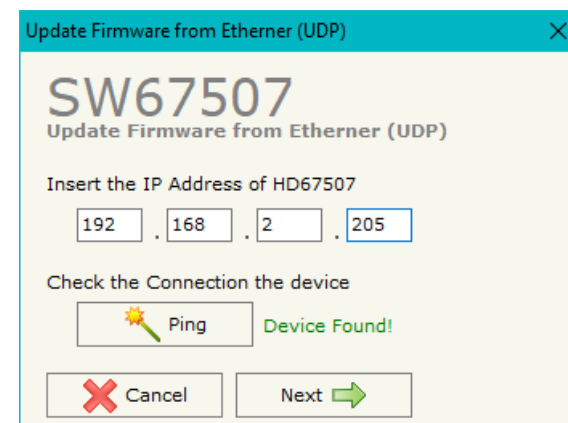

Figure 5: “Update via UDP” windows

**Note:**

When you install a new version of the software, if it is the first time it is better you do the update of the Firmware in the HD67507 device.

**Note:**

When you receive the device, for the first time, you also have to update the Firmware in the HD67507 device.

**Warning:**

If Fig. 6 appears when you try to do the Update try these points before seeking assistance:

- Try to repeat the operations for the updating;
- Try with another PC;
- Try to restart the PC;
- Check the LAN settings;
- Check the Wi-Fi settings;
- If you are using the program inside a Virtual Machine, try to use in the main Operating System;
- If you are using Windows Seven, Vista, 8, 10 or 11 make sure that you have the administrator privileges;
- In case you have to program more than one device, using the "UDP Update", you have to cancel the ARP table every time you connect a new device on Ethernet. For do this you have to launch the "Command Prompt" and write the command "arp -d". Pay attention that with Windows Vista, Seven, 8 you have to launch the "Command Prompt" with Administrator Rights;
- Pay attention at Firewall lock.

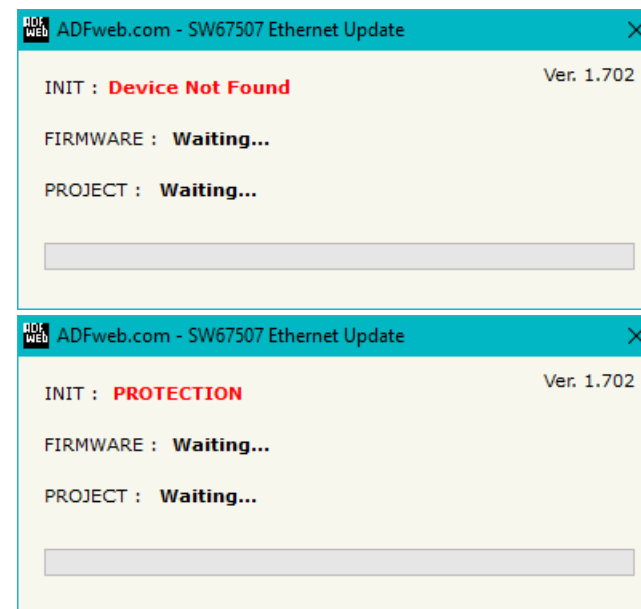
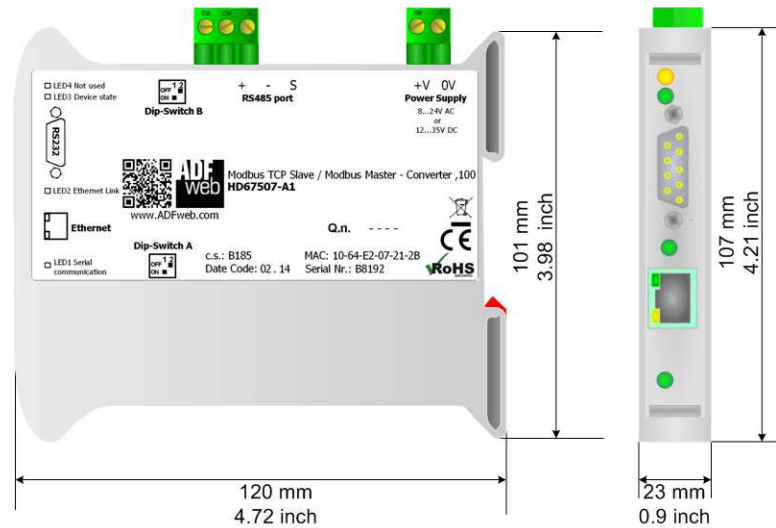

Figure 6: "Error" window

In the case of HD67507 you have to use the software "SW67507": www.adfweb.com/download/filefold/SW67507.zip.

MECHANICAL DIMENSIONS:



Housing: PVC
Weight: 200g (Approx)

Figure 7a: Mechanical dimensions scheme for HD67507-A1

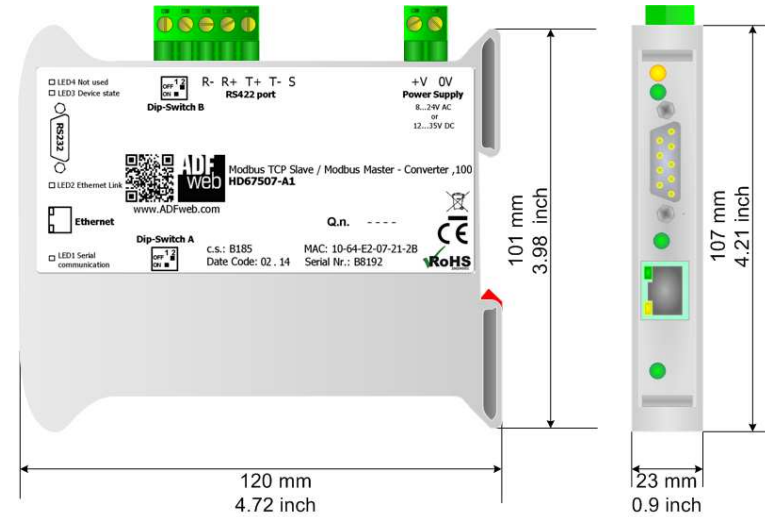

Housing: PVC
Weight: 200g (Approx)

Figure 7b: Mechanical dimensions scheme for HD67507-A1-422

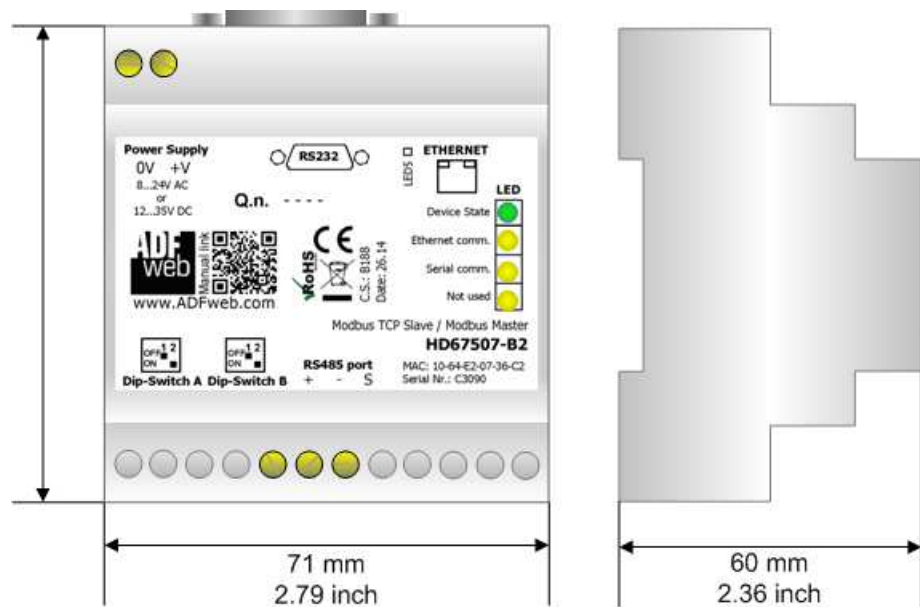

Housing: PVC
 Weight: 200g (Approx)

Figure 7c: Mechanical dimensions scheme for HD67507-B2

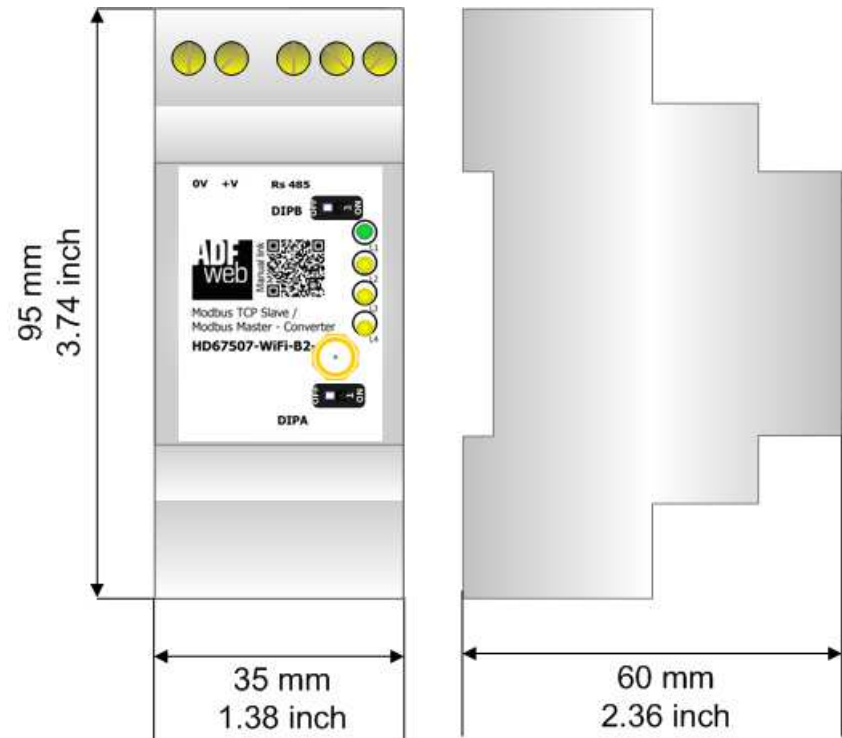

Housing: PVC
Weight: 200g
(Approx)

Figure 7d: Mechanical dimensions scheme for HD67507-WiFi-B2-xxx

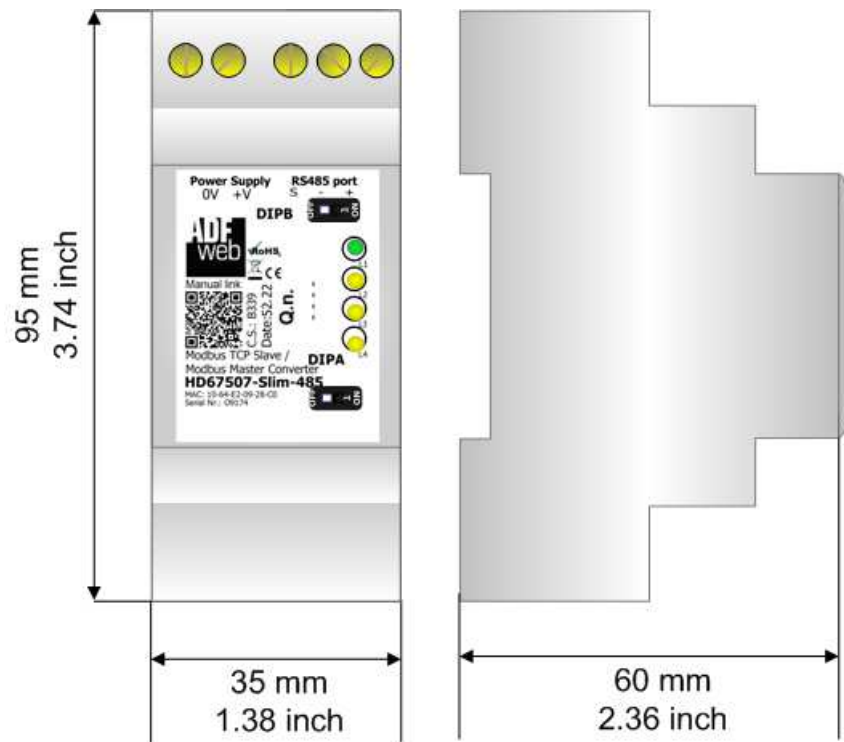

Housing: PVC
Weight: 200g
(Approx)

Figure 7e: Mechanical dimensions scheme for HD67507-Slim-xxx

ORDERING INFORMATIONS:

The ordering part number is formed by a valid combination of the following:

HD67507 - xxxx - xx - xxx

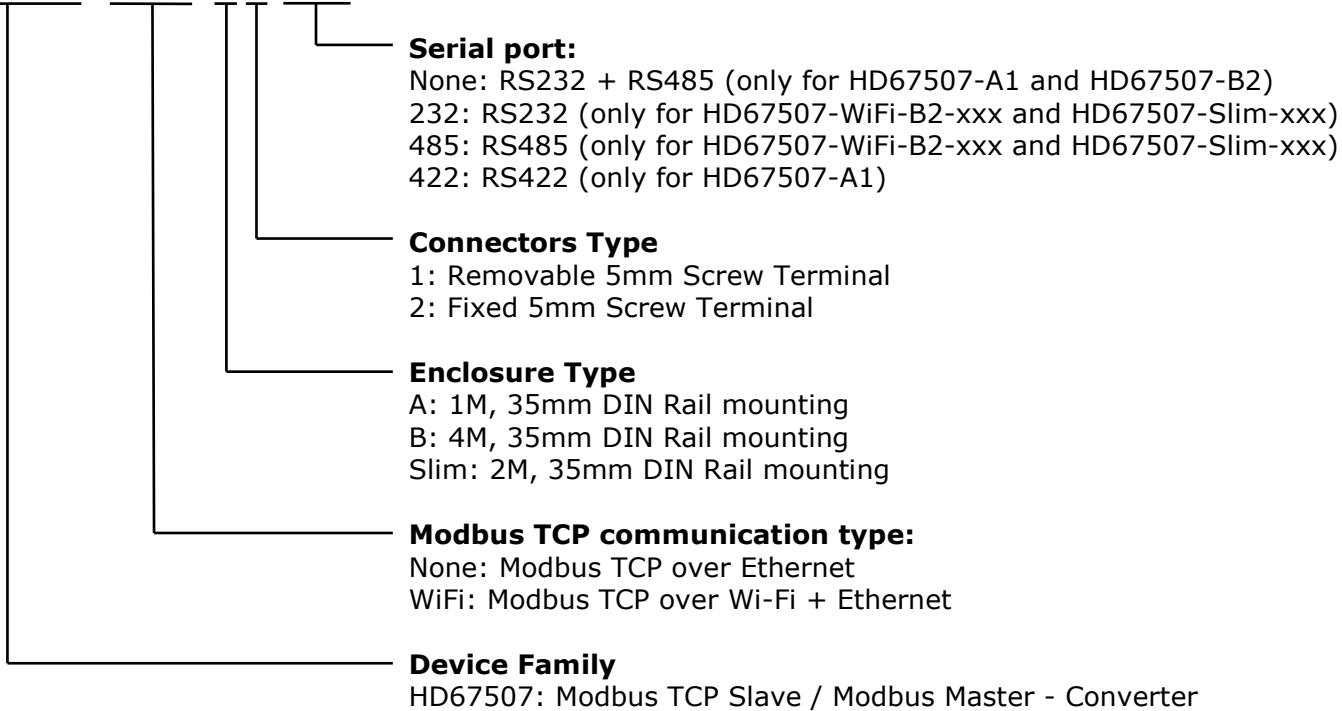

- Order Code: **HD67507-A1** - Modbus TCP Slave / Modbus Master – Converter
(Modbus TCP: Ethernet - Modbus RTU: RS232 or RS485)
- Order Code: **HD67507-A1-422** - Modbus TCP Slave / Modbus Master – Converter
(Modbus TCP: Ethernet - Modbus RTU: RS232 or RS422)
- Order Code: **HD67507-B2** - Modbus TCP Slave / Modbus Master – Converter
(Modbus TCP: Ethernet - Modbus RTU: RS232 or RS485)
- Order Code: **HD67507-Slim-232** - Modbus TCP Slave / Modbus Master – Converter
(Modbus TCP: Ethernet - Modbus RTU: RS232)
- Order Code: **HD67507-Slim-485** - Modbus TCP Slave / Modbus Master – Converter
(Modbus TCP: Ethernet - Modbus RTU: RS485)
- Order Code: **HD67507-WiFi-B2-232** - Modbus TCP Slave / Modbus Master – Converter
(Modbus TCP: Ethernet and Wi-Fi - Modbus RTU: RS232)
- Order Code: **HD67507-WiFi-B2-485** - Modbus TCP Slave / Modbus Master – Converter
(Modbus TCP: Ethernet and Wi-Fi - Modbus RTU: RS485)

ACCESSORIES:

- Order Code: **AC34107** - Null Modem Cable Fem/Fem D-sub 9 Pin 1,5 m
- Order Code: **AC34114** - Null Modem Cable Fem/Fem D-sub 9 Pin 5 m
- Order Code: **AC34011** - Rail DIN - Power Supply 220/240V AC 50/60Hz – 12 V DC
- Order Code: **AC34012** - Rail DIN - Power Supply 220/240V AC 50/60Hz – 24 V DC

DISCLAIMER:

All technical content within this document can be modified without notice. The content of the document is a under continual renewal. For losses due to fire, earthquake, third party access or other accidents, or intentional or accidental abuse, misuse, or use under abnormal conditions repairs are charged to the user. ADFweb.com S.r.l. will not be liable for accidental loss of use or inability to use this product, such as loss of business income. ADFweb.com S.r.l. shall not be liable for consequences of improper use.

OTHER REGULATIONS AND STANDARDS:**WEEE INFORMATION**

Disposal of old electrical and electronic equipment (as in the European Union and other European countries with separate collection systems).

— This symbol on the product or on its packaging indicates that this product may not be treated as household rubbish. Instead, it should be taken to an applicable collection point for the recycling of electrical and electronic equipment. If the product is disposed correctly, you will help prevent potential negative environmental factors and impact of human health, which could otherwise be caused by inappropriate disposal. The recycling of materials will help to conserve natural resources. For more information about recycling this product, please contact your local city office, your household waste disposal service or the shop where you purchased the product.

RESTRICTION OF HAZARDOUS SUBSTANCES DIRECTIVE

The device respects the 2002/95/EC Directive on the restriction of the use of certain hazardous substances in electrical and electronic equipment (commonly referred to as Restriction of Hazardous Substances Directive or RoHS).

CE MARKING

The product conforms with the essential requirements of the applicable EC directives.

WARRANTIES AND TECHNICAL SUPPORT:

For fast and easy technical support for your ADFweb.com SRL products, consult our internet support at www.adfweb.com. Otherwise contact us at the address support@adfweb.com

RETURN POLICY:

If while using your product you have any problem and you wish to exchange or repair it, please do the following:

- ➔ Obtain a Product Return Number (PRN) from our internet support at www.adfweb.com. Together with the request, you need to provide detailed information about the problem.
- ➔ Send the product to the address provided with the PRN, having prepaid the shipping costs (shipment costs billed to us will not be accepted).

If the product is within the warranty of twelve months, it will be repaired or exchanged and returned within three weeks. If the product is no longer under warranty, you will receive a repair estimate.



ADFweb.com S.r.l.
Via Strada Nuova, 17
IT-31010 Mareno di Piave
TREVISO (Italy)
Phone +39.0438.30.91.31
Fax +39.0438.49.20.99
www.adfweb.com

