

User Manual

Revision 1.000
English

Modbus Slave / Modbus TCP Master - Converter

(Order Code: HD67516-A1-232, HD67516-A1-485)

For Website information:

www.adfweb.com?Product=HD67516

For Price information:

www.adfweb.com?Price=HD67516-A1-232

www.adfweb.com?Price=HD67516-A1-485

Benefits and Main Features:

- ⊕ Very easy to configure
- ⊕ 32mm Rail DIN mount
- ⊕ Wide supply input range
- ⊕ Triple electrical isolation
- ⊕ Temperature range: -40°C/+85°C (-40°F/+185°F)



For others products, see also the following links:

RS232 / RS485 / USB / Ethernet

www.adfweb.com?Product=HD67118 (RS232 / RS485 - Converter)

www.adfweb.com?Product=HD67119 (USB / RS485 - Converter)

www.adfweb.com?Product=HD67038 (RS485 / RS232 / Ethernet - Converter)

CAN / CANopen / Modbus / Modbus TCP

www.adfweb.com?Product=HD67001 (CANopen / Modbus Master - Converter)

www.adfweb.com?Product=HD67502 (CANopen / Modbus Slave - Converter)

www.adfweb.com?Product=HD67011 (CAN / Modbus Master - Converter)

www.adfweb.com?Product=HD67012 (CAN / Modbus Slave - Converter)

www.adfweb.com?Product=HD67514 (CAN / Modbus TCP Master - Converter)

www.adfweb.com?Product=HD67515 (CAN / Modbus TCP Slave - Converter)

Modbus TCP Slave / Modbus Master - Converter

www.adfweb.com?Product=HD67507

www.adfweb.com?Product=HD67508

Do you have your customer protocol? Then go to:

www.adfweb.com?Product=HD67003

Do you need to choose a device? Do you want help?

www.adfweb.com?Cmd=helpme



User Manual

INDEX:

	Page
INDEX	2
UPDATED DOCUMENTATION	2
REVISION LIST	2
WARNING	2
TRADEMARKS	2
SECURITY ALERT	3
EXAMPLES OF CONNECTION	4
CONNECTION SCHEME	5
CHARACTERISTICS	7
POWER SUPPLY	8
FUNCTION MODES	9
LEDS	10
ETHERNET	11
RS232	11
RS485	12
USE OF COMPOSITOR SW67516	13
NEW CONFIGURATION / OPEN CONFIGURATION	14
SOFTWARE OPTIONS	15
SET COMMUNICATION	16
UPDATE VIA UDP	23
MECHANICAL DIMENSIONS	25
ORDERING INFORMATIONS	26
ACCESSORIES	26
DISCLAIMER	27
OTHER REGULATIONS AND STANDARDS	27
WARRANTIES AND TECHNICAL SUPPORT	28
RETURN POLICY	28

UPDATED DOCUMENTATION:

Dear customer, we thank you for your attention and we remind you that you need to check that the following document is:

- Updated
- Related to the product you own

To obtain the most recently updated document, note the “document code” that appears at the top right-hand corner of each page of this document.

With this “Document Code” go to web page www.adfweb.com/download/ and search for the corresponding code on the page. Click on the proper “Document Code” and download the updates.

REVISION LIST:

Revision	Date	Author	Chapter	Description
1.000	15/06/2016	Ff	All	First Release version

WARNING:

ADFweb.com reserves the right to change information in this manual about our product without warning. ADFweb.com is not responsible for any error this manual may contain.

TRADEMARKS:

All trademarks mentioned in this document belong to their respective owners.

SECURITY ALERT:**GENERAL INFORMATION**

To ensure safe operation, the device must be operated according to the instructions in the manual. When using the device, legal and safety regulation are required for each individual application. The same applies also when using accessories.

INTENDED USE

Machines and systems must be designed so the faulty conditions do not lead to a dangerous situation for the operator (i.e. independent limit switches, mechanical interlocks, etc.).

QUALIFIED PERSONNEL

The device can be used only by qualified personnel, strictly in accordance with the specifications. Qualified personnel are persons who are familiar with the installation, assembly, commissioning and operation of this equipment and who have appropriate qualifications for their job.

RESIDUAL RISKS

The device is state-of-the-art and is safe. The instruments can represent a potential hazard if they are inappropriately installed and operated by untrained personnel. These instructions refer to residual risks with the following symbol:



This symbol indicates that non-observance of the safety instructions is a danger for people that could lead to serious injury or death and / or the possibility of damage.

CE CONFORMITY

The declaration is made by our company. You can send an email to support@adfweb.com or give us a call if you need it.

EXAMPLES OF CONNECTION:

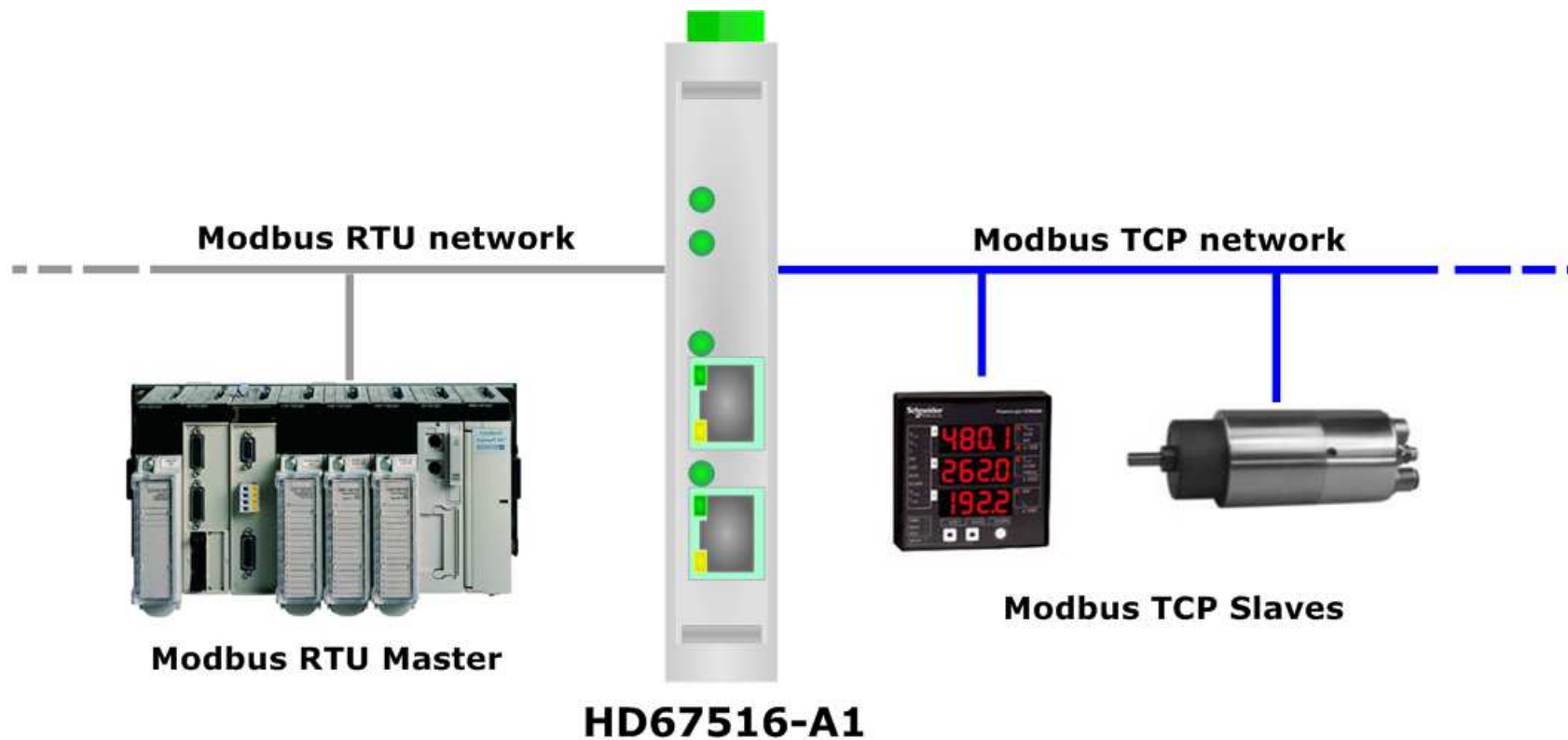

CONNECTION SCHEME:

Dip-Switch A:
 -Dip1 – Must be at ON
 -Dip2 – Functioning Mode
 = Normal = Boot

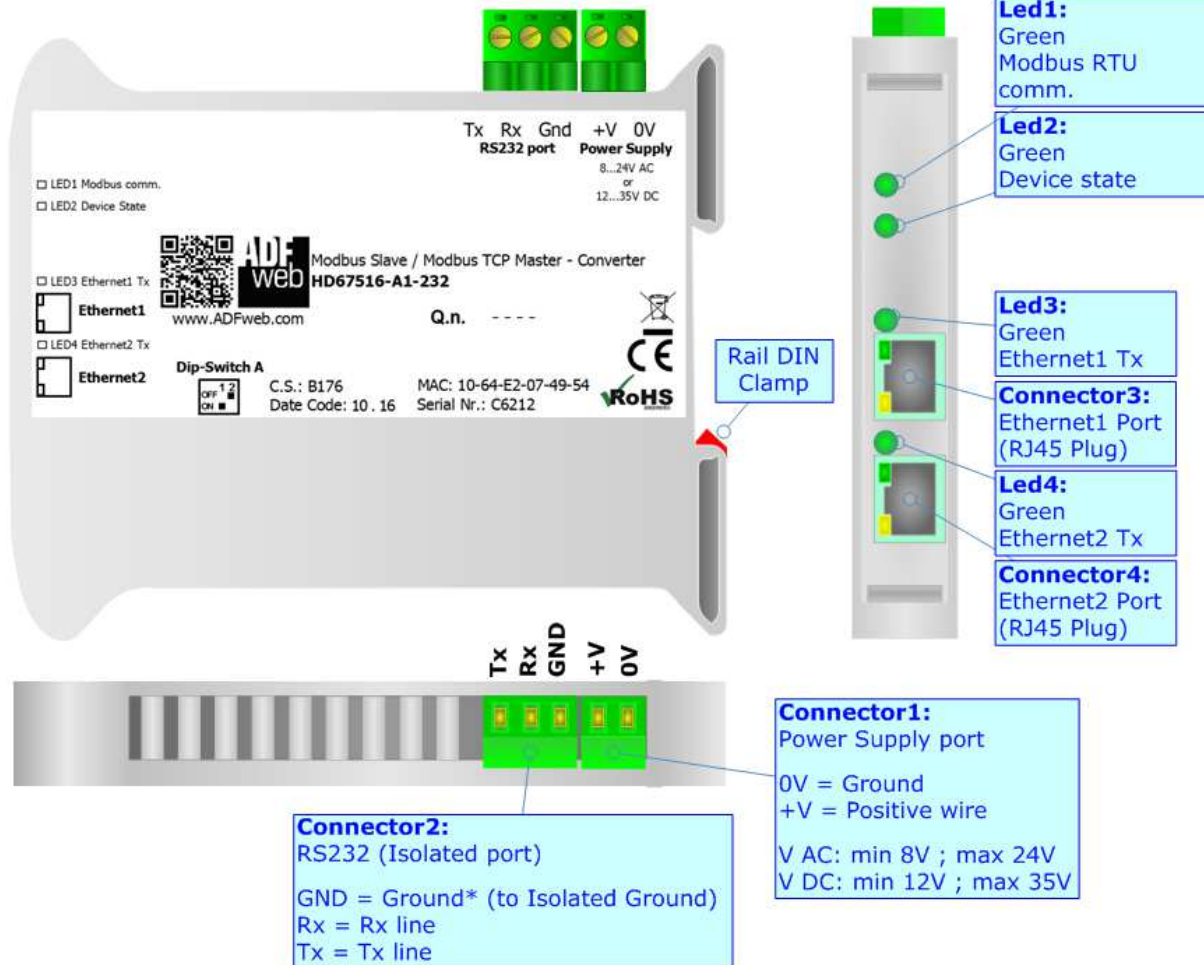
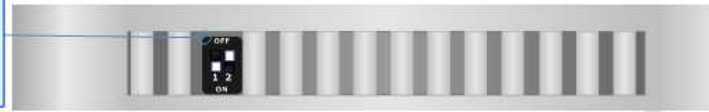

Figure 1a: Connection scheme for HD67516-A1-232

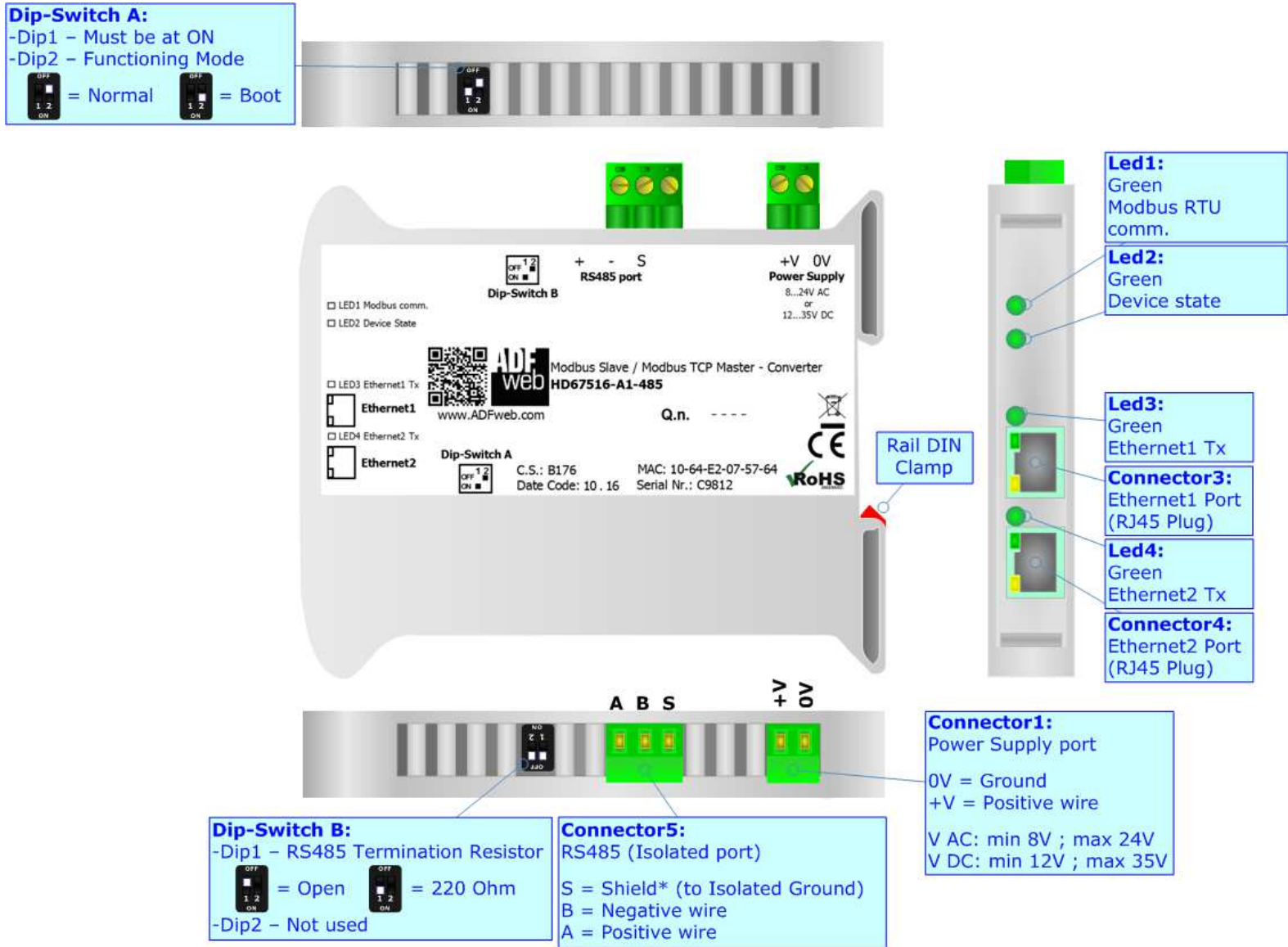

Figure 1b: Connection scheme for HD67516-A1-485

CHARACTERISTICS:

The HD67516-A1 is a Modbus Slave / Modbus TCP Master – Converter.

It allows for the following characteristics:

- Triple isolation between Serial - Power Supply, Serial - Ethernet, Power Supply - Ethernet.
- Ethernet 10Base-T / 100Base-T, autosensing for Modbus TCP ;
- Mountable on 35mm Rail DIN;
- Wide power supply input range: 8...24V AC or 12...35V DC;
- Wide temperature range: -40°C / 85°C [-40°F / +185°F].

CONFIGURATION:

You need Compositor SW67516 software on your PC in order to perform the following:

- Define the parameters of Modbus TCP line;
- Define the parameters of Serial Modbus line;
- Update the device.

POWER SUPPLY:

The devices can be powered at 8...24V AC and 12...35V DC. For more details see the two tables below.

VAC 		VDC 	
Vmin	Vmax	Vmin	Vmax
8V	24V	12V	35V

Consumption at 24V DC:

Device	Consumption [W/VA]
HD67516-A1-232	3.5
HD67516-A1-485	3.5

 **Caution: Not reverse the polarity power**

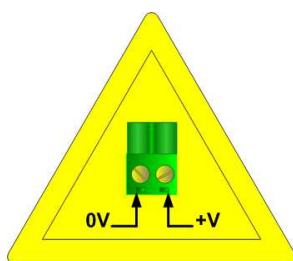

HD67516-A1

Connector1:
 Power Supply port
 0V = Ground
 +V = Positive wire
 V AC: min 8V ; max 24V
 V DC: min 12V ; max 35V

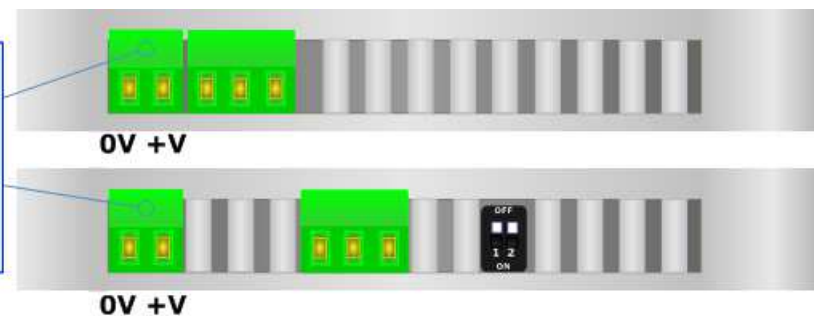

FUNCTION MODES:

The device has got two function modes depending on the position of the 'Dip2 of Dip-Switch A':

- The first, with 'Dip2 of Dip-Switch A' at "OFF" position, is used for the normal working of the device.
- The second, with 'Dip2 of Dip-Switch A' at "ON" position, is used for uploading the Project and/or Firmware.

For the operations to follow for the updating, see 'UPDATE DEVICE' section.

According to the functioning mode, the LEDs will have specific functions, see 'LEDS' section.

**Warning:**

Dip1 of 'Dip-Switch A' must be at ON position to work even if the Ethernet cable is not inserted.

LEDS:

The devices has got four LEDs that are used to give information of the functioning status.
The various meanings of the LEDs are described in the table below.

LED	Normal Mode	Boot Mode
1: Modbus RTU communication (green)	Blinks when Modbus requests are received (RS232/RS485)	Blinks quickly: Boot state Blinks very slowly (~0.5Hz): update in progress
2: Device state (green)	Blinks slowly (~1Hz)	Blinks quickly: Boot state Blinks very slowly (~0.5Hz): update in progress
3: Ethernet1 Tx (green)	Blinks quickly for a short time when Ethernet frames are sent	Blinks quickly: Boot state Blinks very slowly (~0.5Hz): update in progress
4: Ethernet2 Tx (green)	Blinks quickly for a short time when Ethernet frames are sent	Blinks quickly: Boot state Blinks very slowly (~0.5Hz): update in progress

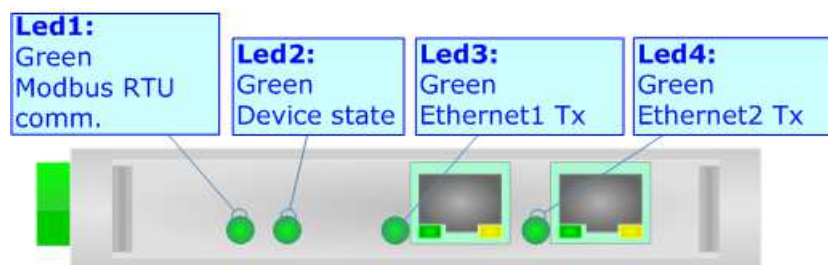

ETHERNET:

The Ethernet connection must be made using Connector3/Connector4 of HD67516-A1 with at least a Category 5E cable. The maximum length of the cable should not exceed 100m. The cable has to conform to the T568 norms relative to connections in cat.5 up to 100 Mbps. To connect the device to a Hub/Switch the use of a straight cable is recommended. To connect the device to a PC/PLC/other the use of a cross cable is recommended.

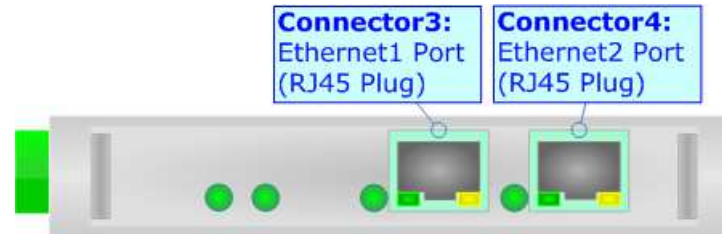

RS232:

The connection from a RS232 socket to a serial port (example one from a personal computer) must be made with a NULL MODEM cable (a serial cable where the pins 2 and 3 are crossed). It is recommended that the RS232 cable not exceed 15 meters.

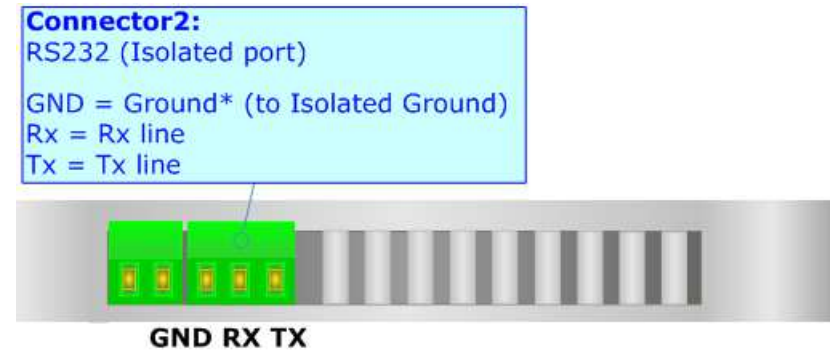

RS485:

To terminate the RS485 line with a 220Ω resistor, it is necessary to put dip 1 ON, like in figure.

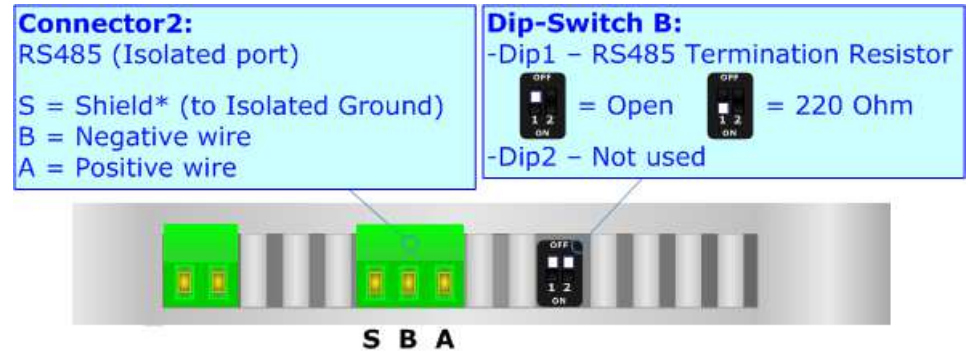

The maximum length of the cable should be 1200m (4000 feet).

Here some codes of cables:

- Belden: p/n 8132 - 2x 28AWG stranded twisted pairs conductor + foil shield + braid shield;
- Belden p/n 82842 - 2x 24AWG stranded twisted pairs conductor + foil shield + braid shield;
- Tasker: p/n C521 - 1x 24AWG twisted pair conductor + foil shield + braid shield;
- Tasker: p/n C522 - 2x 24AWG twisted pairs conductor + foil shield + braid shield.

USE OF COMPOSITOR SW67516:

To configure the Converter, use the available software that runs with Windows called SW67516. It is downloadable on the site www.adfweb.com and its operation is described in this document. *(This manual is referenced to the last version of the software present on our web site)*. The software works with MSWindows (XP, Vista, Seven, 8, 10; 32/64bit).

When launching the SW67516, the window on the right appears (Fig. 2).

 **Note:**
It is necessary to have installed .Net Framework 4.



Figure 2: Main window for SW67516

NEW CONFIGURATION / OPEN CONFIGURATION:

The “**New Configuration**” button creates the folder which contains the entire device’s configuration.

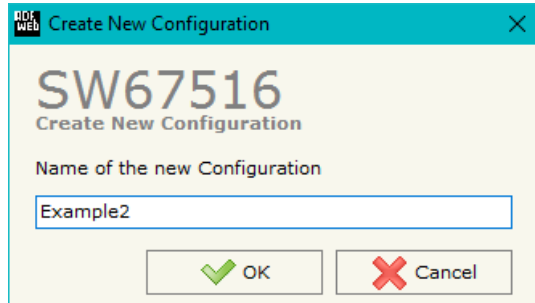

A device’s configuration can also be imported or exported:

- To clone the configurations of a Programmable “Modbus Slave / Modbus TCP Master - Converter” in order to configure another device in the same manner, it is necessary to maintain the folder and all its contents;
- To clone a project in order to obtain a different version of the project, it is sufficient to duplicate the project folder with another name and open the new folder with the button “**Open Configuration**”.

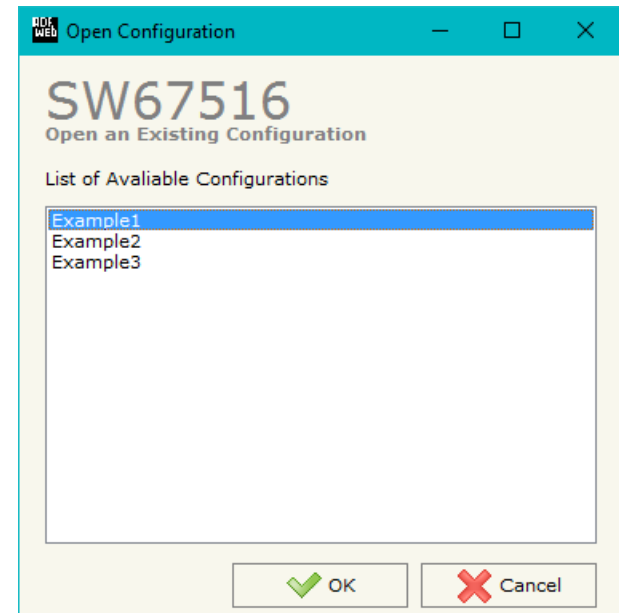

SOFTWARE OPTIONS:

By pressing the “**Settings**” () button there is the possibility to change the language of the software and check the updatings for the compositor.

In the section “Language” it is possible to change the language of the software.

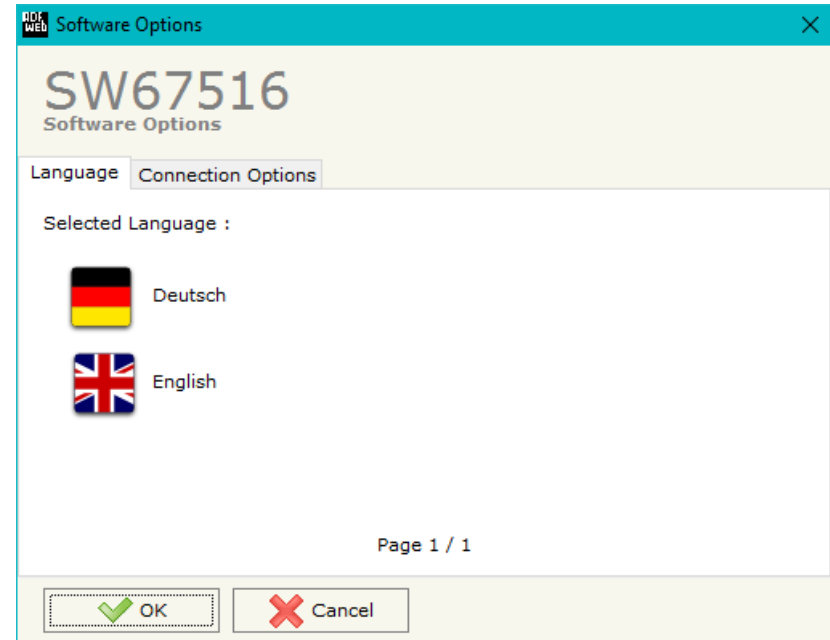
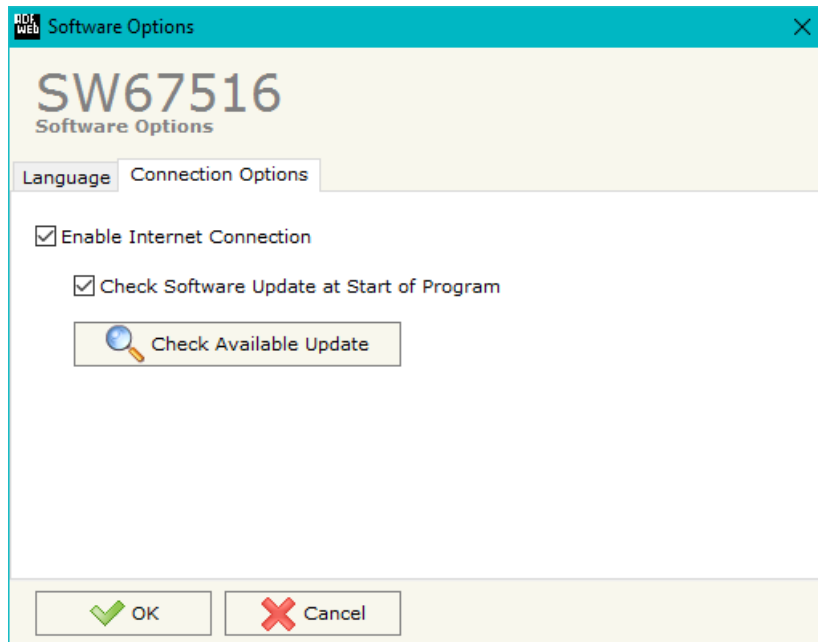

In the section “Connection Options”, it is possible to check if there are some updatings of the software compositor in ADFweb.com website. Checking the option “**Check Software Update at Start of Program**”, the SW67516 check automatically if there are updatings when it is launched.

SET COMMUNICATION:

This section defines the fundamental communication parameters of two buses, Modbus TCP and Modbus RTU.

By pressing the **Set Communication** button from the main window for SW67516 (Fig. 2) the window "Set Communication" appears (Fig. 3).

The section "Operation Mode" defines the operation of the Converter in **Normal Mode (with Translate Table)**, **Routing Slave Address** or **Work with Fix IP Address** (see the description at page 18).

The means for the fields of "Modbus TCP master" are:

- In the field **IP Address** the IP address of the converter is defined;
- In the field **Subnet Mask** the SubNet Mask is defined;
- In the fields **GATEWAY** the default gateway of the network is defined. This feature can be enabled or disabled pressing the Check Box field. This feature is used for going out of the net;
- In the field **Port** the port used for Modbus TCP communication is defined;
- In the field **Timeout (ms)** the maximum time that the device has to attend for the answer from the Slave interrogated is defined;
- If the field **Don't disconnect the socket** is checked, when the Converter receives the TCP response it does not disconnect the opened socket (open the socket only at the first RTU request and then the socket remains opened); otherwise for every RTU requests the Converter opens the socket and when it receives the TCP response it closes it;

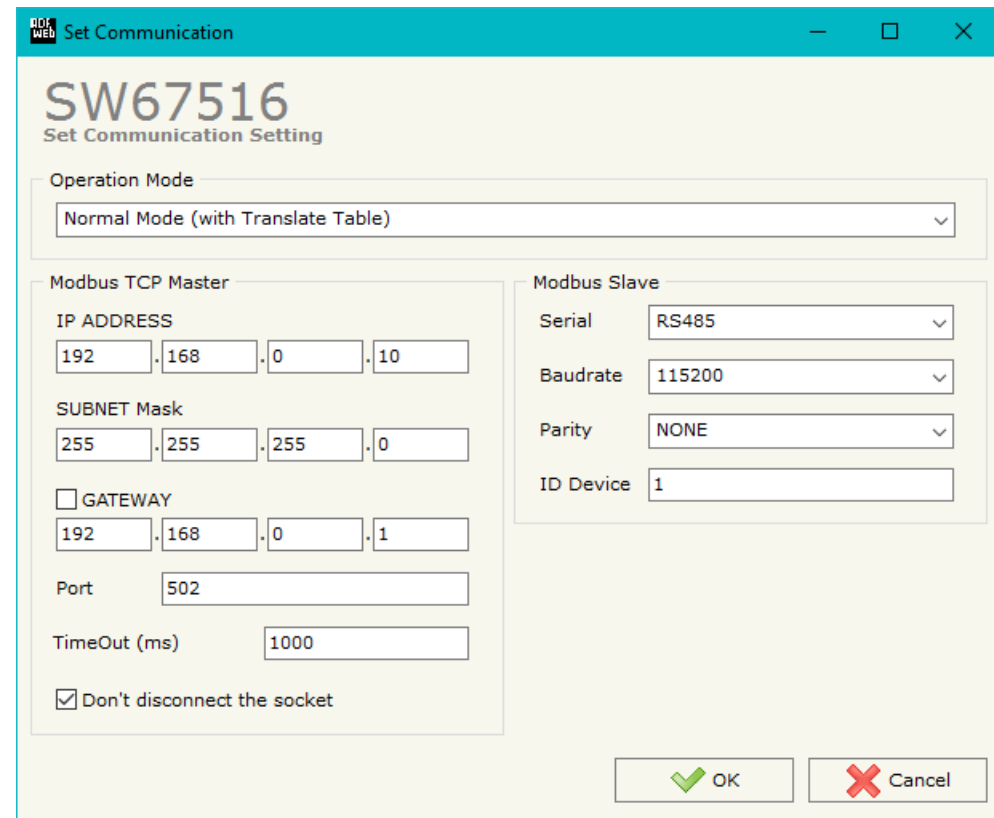

Figure 3: "Set Communication" window

- In the field "**Fix IP Address**" the IP address of the Modbus TCP slave device to which the converter sends the requests is defined. This field is visible only if the selected "Operation Mode" is "Work with Fix IP Address".

The means for the fields of "Modbus Slave" are:

- In the field "**Serial**" the serial line to use for Modbus communication is defined (RS232 or RS485);
- In the field "**Baudrate**" the baudrate for the serial line is defined;
- In the field "**Parity**" the parity of the serial line is defined;
- In the field "**ID Device**" the address of serial Modbus device is defined. This field can be compiled only if the selected "Operation Mode" is "Normal Mode (with Translate Table)" or "Work with Fix IP Address";
- If the field "**Enable Broadcast message with ID zero**" is checked, it is possible to send broadcast requests using slave ID 0 on Modbus RTU side. In this way, it is possible to send more requests in one time defined in the "Translate Table" with a single RTU request. This field is available only if the selected "Operation Mode" is "Routing Slave Address".

Operation Mode:

With this field is possible to select how the converter functions; there are three options:

- NORMAL MODE (WITH TRANSLATE TABLE)
Using this function, the Converter can be seen like a single serial Modbus slave. The address of Modbus is assigned in the "Set Communication" section.
- ROUTING SLAVE ADDRESS
Using this function, the Converter can be seen like more than one serial Modbus slave. Each serial Modbus slave is a row of the table, and it is possible to assign to which TCP device is linked.
- WORK WITH FIX IP ADDRESS
Using this function, the Converter can be seen like a single serial Modbus slave. The address of Modbus is assigned in the "Set Communication" section.
In this mode of functioning is not necessary to compile the Translate Table; every request that arrives on serial is transferred on TCP (using TCP format of frame) to the slave with the IP address defined in the "Set Communication" section.

NORMAL MODE (WITH TRANSLATE TABLE):

Using this function, the Converter can be seen like a single serial Modbus slave. The address of Modbus is assigned in the “Set Communication” section.

By pressing the “**Translate Table**” button from the main window for SW67516 (Fig. 2), the window “Set Translate Table” appears (Fig. 4).

The data of the columns have the following meanings:

- In the field “**Data Type**” the type of data that is being considered is defined;
- In the field “**Address**” the address of the Modbus register to be read/written on serial side is defined;
- In the field “**IP Address TCP**” the IP address of the device on the Modbus TCP that contains the data is defined;
- In the field “**Address TCP**” the address of the Modbus register on the TCP device linked to the request from serial side is defined;
- In the field “**N° Point**” the number of consecutive Modbus registers is defined. For example, you create Address =100, Address TCP=150 and N° point = 5, the following gets set-up automatically: Addresses TCP 150, 151, 152, 153, 154 and the serial Modbus variables 100, 101, 102, 103, 104;
- In the field “**Mnemonic**” a brief description is defined.

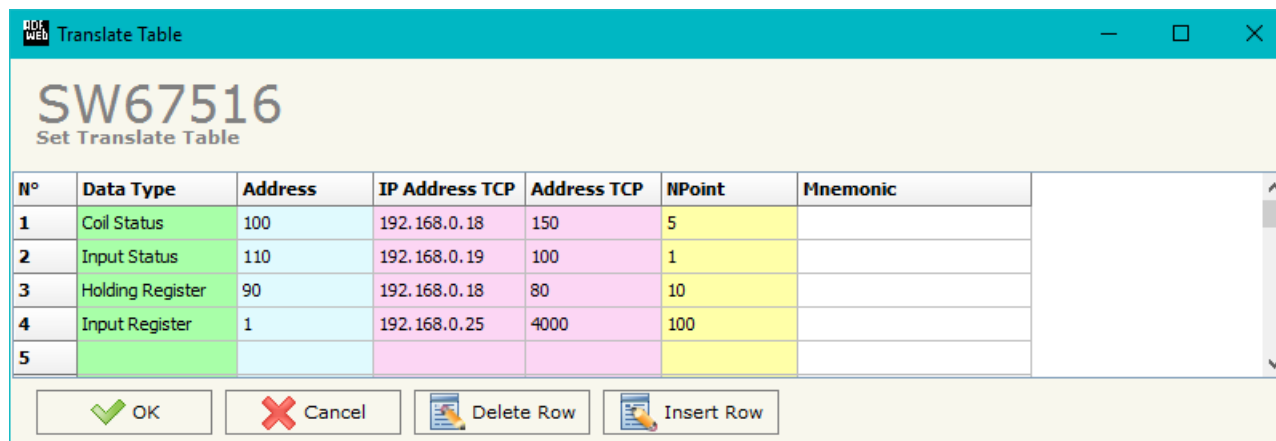

Figure 4: “Set Translate Table” window

EXAMPLE 1:

Taking the first row of Figure 4:

Step 1: A serial Modbus master do the request to the Converter to read the "Coil Status" address 100 for 5 consecutive points;

Step 2: The Converter sends to the TCP Slave 192.168.0.18 the read request of "Coil Status" address 150 for 5 consecutive points;

Step 3: The slave TCP replies to the Converter with the data;

Step 4: The Converter sends back the data on serial.

EXAMPLE 2:

Taking the second row of Figure 4:

Step 1: A serial Modbus master do the request to the Converter to read the "Input Status" address 110;

Step 2: The Converter sends to the TCP Slave 192.168.0.19 the read request of address 100;

Step 3: The slave TCP replies to the Converter with the data;

Step 4: The Converter sends back the data on serial.

EXAMPLE 3:

Taking the third row of Figure 4:

Step 1: A serial Modbus master do the request to the Converter to read the "Holding Register" address 90 for 10 consecutive points;

Step 2: The Converter sends to the TCP Slave 192.168.0.18 the read request of "Holding Register" address 80 for 10 consecutive points;

Step 3: The slave TCP replies to the Converter with the data;

Step 4: The Converter sends back the data on serial.

Note:

If the TCP slave responds with an exception, that exception code will be transmitted to the serial master. If the TCP slave does not respond within the estimated time defined by the Timeout parameter, an exception response will be given: error code \$36.

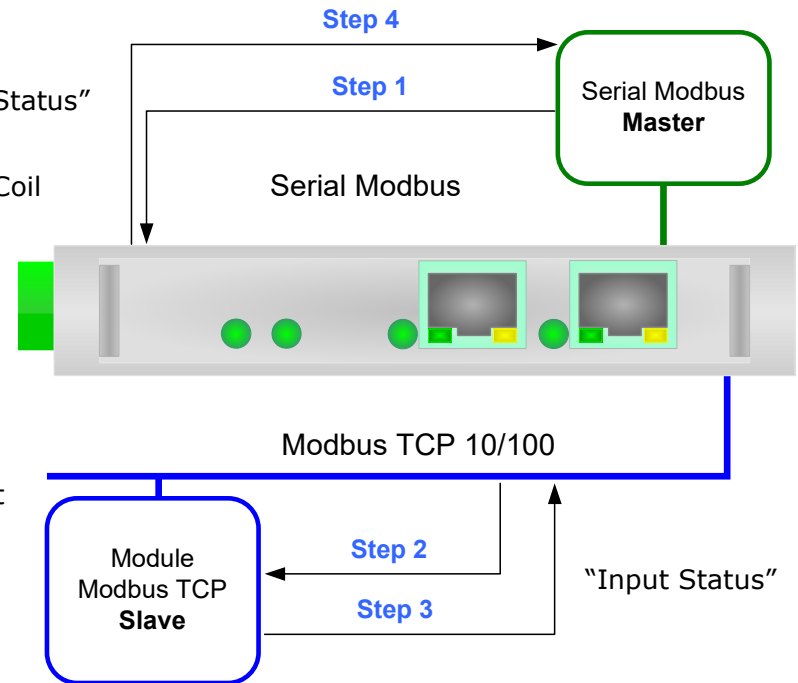

Figure 5: Chart of Request data from serial Modbus

ROUTING SLAVE ADDRESS:

Using this function, the Converter can be seen like more than one serial Modbus slave. Each serial Modbus slave is a row of the table, and it is possible to assign to which TCP device is linked.

By pressing the **“Translate Table”** button from the main window for SW67516 (Fig. 2) the window **“Set Translate Table”** appears (Fig. 6).

The data of the columns have the following meanings:

- In the field **“Slave ID”** the virtual address of the device is defined;
- In the field **“IP Address TCP”** the IP address of the device on Modbus TCP side that contains the data is defined;
- In the field **“Slave ID TCP”** the address of the device at TCP device is defined;
- If the field **“Reserved Socket”** is checked, the converter will reserve a socket for the specific Modbus TCP slave. This socket will be closed only after the number of consecutive errors defined in the **“Errors Sock”** column. It is possible to reserve up to 3 sockets for 3 different Modbus TCP slaves;
- If the field **“UDP”** is checked, the converter will send the request on Modbus TCP side using UDP protocol;
- If the field **“Broadcast”** is checked, the converter will send the UDP message in Broadcast. With this setting, it is necessary to set the field **“IP Address TCP”** with the Broadcast IP Address to use and the converter will not expect a response from the slave device. This option can be used only if **“UDP”** field is checked;
- In the field **“Mnemonic”** a brief description is defined.

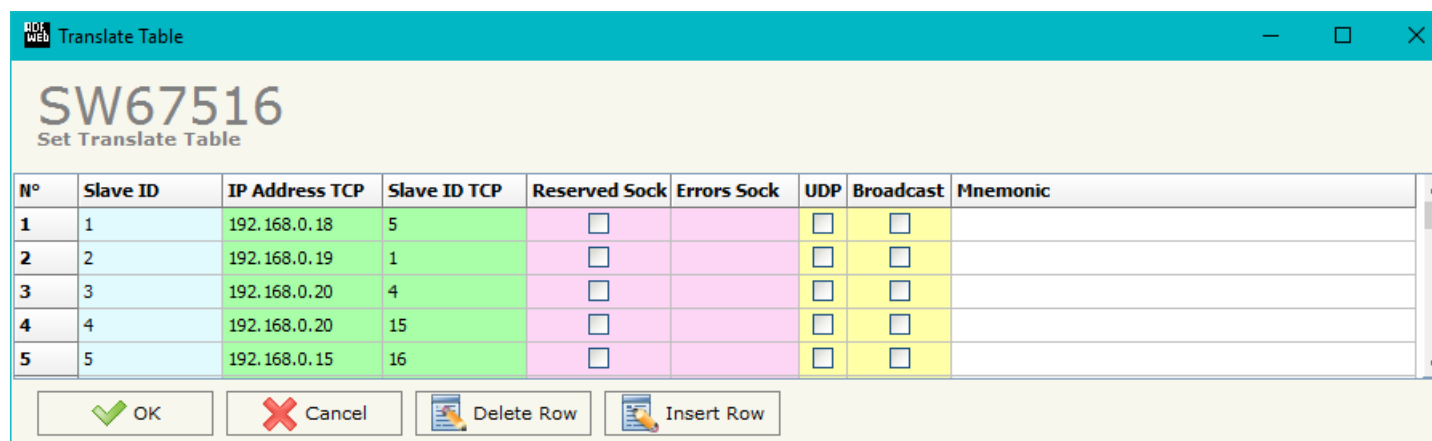

Figure 6: **“Set Translate Table”** window

EXAMPLE 1:

Taking the first row of Figure 6:

Step 1: A serial Modbus master do the request to the Converter to read/write a register from the serial slave Modbus ID 1;

Step 2: The Converter sends to the TCP slave 192.168.0.18 the read/write request using the TCP slave ID 5;

Step 3: The slave TCP replies to the Converter with the data;

Step 4: The Converter sends back the data on serial.

EXAMPLE 2:

Taking the second row of Figure 6:

Step 1: A serial Modbus master do the request to the Converter to read/write a register from the serial slave Modbus ID 2;

Step 2: The Converter sends to the TCP slave 192.168.0.19 the read/write the TCP slave ID 1;

Step 3: The slave TCP replies to the Converter with the data;

Step 4: The Converter sends back the data on serial.

EXAMPLE 3:

Taking the third row of Figure 6:

Step 1: A serial Modbus master do the request to the Converter to read/write a register from the serial slave Modbus ID 3;

Step 2: The Converter sends to the TCP slave 192.168.0.20 the read/write request using the TCP slave ID 4;

Step 3: The slave TCP replies to the Converter with the data;

Step 4: The Converter sends back the data on serial.

Note:

If the TCP slave responds with an exception, that exception code will be transmitted to the serial master. If the TCP slave does not respond within the estimated time defined by the Timeout parameter, an exception response will be given: error code \$36.

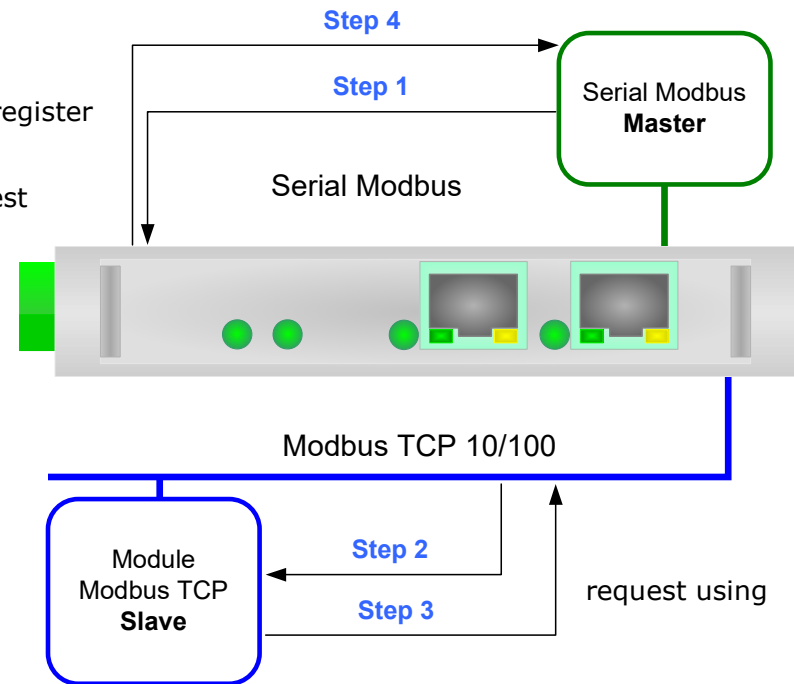

Figure 7: Chart of Request data from serial Modbus

WORK WITH FIX IP ADDRESS:

Using this function, the Converter can be seen like a single serial Modbus slave. The address of Modbus is assigned in the "Set Communication" section.

In this mode of working is not necessary to compile a Translate Table; every request that arrives on serial is transferred on TCP (using TCP format of frame) to the slave with the IP address defined in the "Set Communication" section.

EXAMPLE 1:

Using the configuration of Figure 3:

- Step 1:** A serial Modbus master do the request to the Converter to read/write a register from the RTU Slave Address 1;
- Step 2:** The Converter sends to the TCP slave the read/write request;
- Step 3:** The slave TCP replies to the Converter with the data;
- Step 4:** The Converter sends back the data on serial.

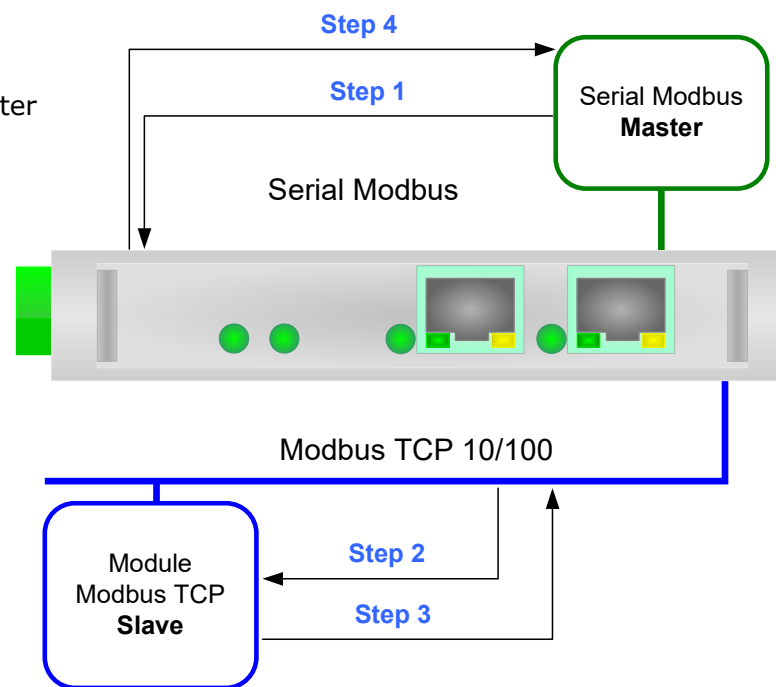

Figure 8: Chart of Request data from serial Modbus

Note: If the TCP slave responds with an exception, that exception code will be transmitted to the serial master. If the TCP slave does not respond within the estimated time defined by the Timeout parameter, an exception response will be given: error code \$36.

UPDATE VIA UDP:

By pressing the **"Update via UDP"** button, it is possible to load the created configuration into the device if necessary. This by using the Ethernet port.

If you don't know the actual IP address of the device you have to use this procedure:

- Turn off the Device;
- Put Dip2 of 'Dip-Switch A' in ON position;
- Turn on the device
- Connect the Ethernet cable;
- Insert the IP **"192.168.2.205"**;
- Press the **"Ping"** button, "Device Found! must appear";
- Press the **"Next"** button;
- Select which operations you want to do;
- Press the **"Execute update firmware"** button to start the upload;
- When all the operations are "OK" turn off the Device;
- Put Dip2 of 'Dip-Switch A' in OFF position;
- Turn on the device.

If you know the actual IP address of the device, you have to use this procedure:

- Turn on the Device with the Ethernet cable inserted;
- Insert the actual IP of the Converter;
- Press the **"Ping"** button, must appear "Device Found!";
- Press the **"Next"** button;
- Select which operations you want to do;
- Press the **"Execute update firmware"** button to start the upload;
- When all the operations are "OK" the device automatically goes at Normal Mode.

At this point the configuration/firmware on the device is correctly updated.

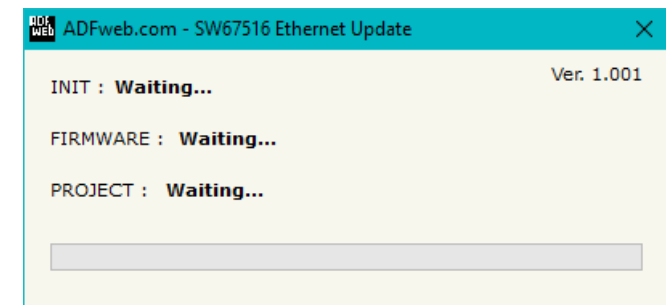
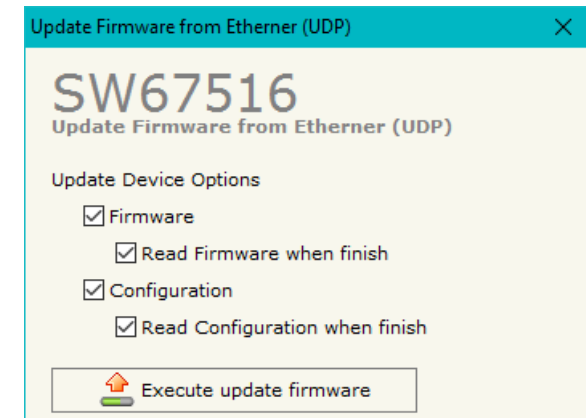
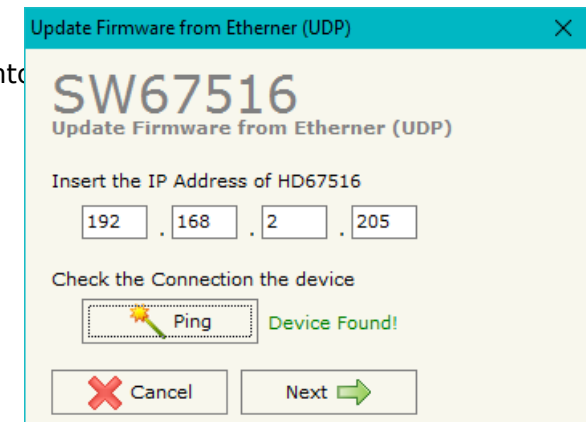





Figure 9: "Update device" windows

 **Note:**
When you install a new version of the software, if it is the first time it is better you do the update of the Firmware in the HD67516 device.

 **Note:**
When you receive the device, for the first time, you also have to update the Firmware in the HD67516 device.

 **Warning:**
If Fig. 6 appears when you try to do the Update try these points before seeking assistance:

- Try to repeat the operations for the updating;
- Try with another PC;
- Try to restart the PC;
- Check the LAN settings;
- Check the Wi-Fi settings;
- If you are using the program inside a Virtual Machine, try to use in the main Operating System;
- If you are using Windows Seven, Vista, 8 or 10 make sure that you have the administrator privileges;
- In case you have to program more than one device, using the "UDP Update", you have to cancel the ARP table every time you connect a new device on Ethernet. For do this you have to launch the "Command Prompt" and write the command "arp -d". Pay attention that with Windows Vista, Seven, 8, 10 you have to launch the "Command Prompt" with Administrator Rights;
- Pay attention at Firewall lock.

 In the case of HD67516 you have to use the software "SW67516": www.adfweb.com/download/filefold/SW67516.zip.

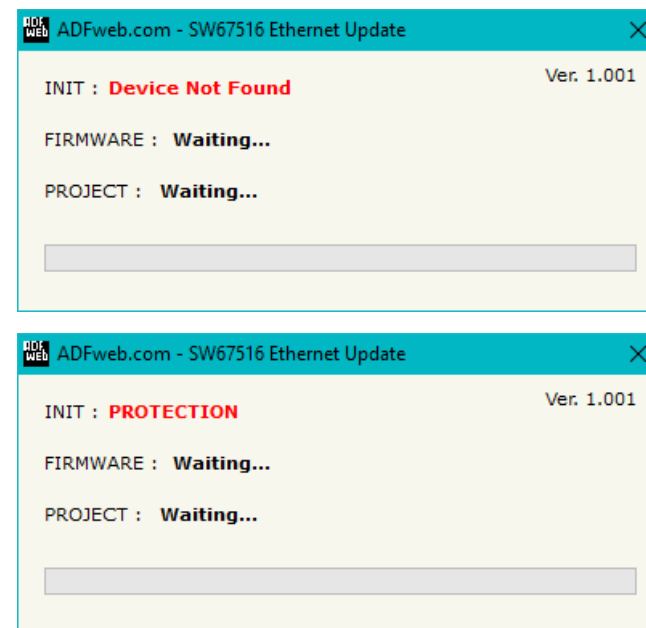
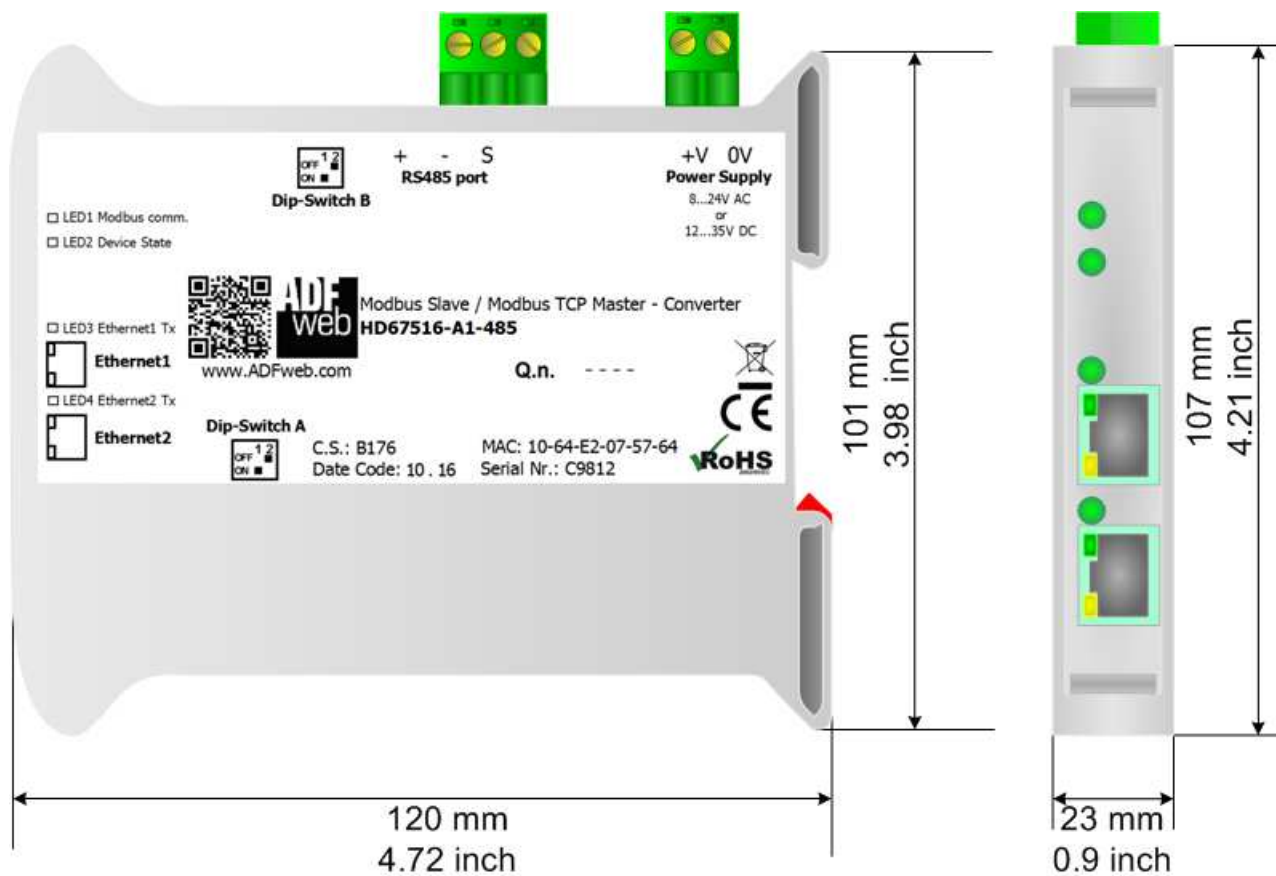

Figure 10: "Protection" window

MECHANICAL DIMENSIONS:



Housing: PVC
 Weight: 200g (Approx)

Figure 10: Mechanical dimensions scheme for HD67516-A1-xxx

ORDERING INFORMATIONS:

The ordering part number is formed by a valid combination of the following:

HD67516 - A 1 - xxx

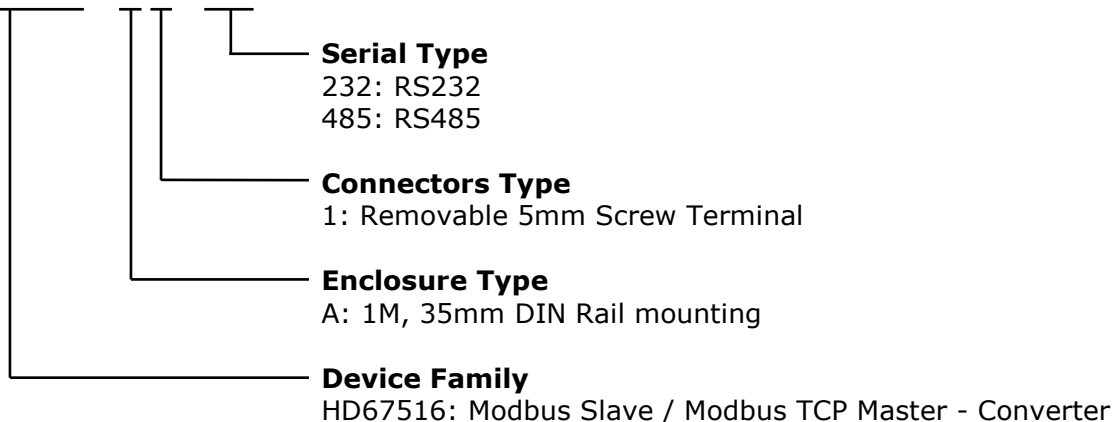

Order Code: **HD67516-A1-232** - Modbus Slave / Modbus TCP Master - Converter (Ethernet Switch Inside for enter/exit connection)

Order Code: **HD67516-A1-485** - Modbus Slave / Modbus TCP Master - Converter (Ethernet Switch Inside for enter/exit connection)

ACCESSORIES:

Order Code: **AC34107** - Null Modem Cable Fem/Fem D-sub 9 Pin 1,5 m

Order Code: **AC34114** - Null Modem Cable Fem/Fem D-sub 9 Pin 5 m

Order Code: **AC34001** - Rail DIN - Power Supply 220/240V AC 50/60Hz – 12 V AC

Order Code: **AC34002** - Rail DIN - Power Supply 110V AC 50/60Hz – 12 V AC

DISCLAIMER:

All technical content within this document can be modified without notice. The content of the document is a under continual renewal. For losses due to fire, earthquake, third party access or other accidents, or intentional or accidental abuse, misuse, or use under abnormal conditions repairs are charged to the user. ADFweb.com S.r.l. will not be liable for accidental loss of use or inability to use this product, such as loss of business income. ADFweb.com S.r.l. shall not be liable for consequences of improper use.

OTHER REGULATIONS AND STANDARDS:**WEEE INFORMATION**

Disposal of old electrical and electronic equipment (as in the European Union and other European countries with separate collection systems).

— This symbol on the product or on its packaging indicates that this product may not be treated as household rubbish. Instead, it should be taken to an applicable collection point for the recycling of electrical and electronic equipment. If the product is disposed correctly, you will help prevent potential negative environmental factors and impact of human health, which could otherwise be caused by inappropriate disposal. The recycling of materials will help to conserve natural resources. For more information about recycling this product, please contact your local city office, your household waste disposal service or the shop where you purchased the product.

RESTRICTION OF HAZARDOUS SUBSTANCES DIRECTIVE

The device respects the 2002/95/EC Directive on the restriction of the use of certain hazardous substances in electrical and electronic equipment (commonly referred to as Restriction of Hazardous Substances Directive or RoHS).

CE MARKING

The product conforms with the essential requirements of the applicable EC directives.

WARRANTIES AND TECHNICAL SUPPORT:

For fast and easy technical support for your ADFweb.com SRL products, consult our internet support at www.adfweb.com. Otherwise contact us at the address support@adfweb.com

RETURN POLICY:

If while using your product you have any problem and you wish to exchange or repair it, please do the following:

- Obtain a Product Return Number (PRN) from our internet support at www.adfweb.com. Together with the request, you need to provide detailed information about the problem.
- Send the product to the address provided with the PRN, having prepaid the shipping costs (shipment costs billed to us will not be accepted).

If the product is within the warranty of twelve months, it will be repaired or exchanged and returned within three weeks. If the product is no longer under warranty, you will receive a repair estimate.



ADFweb.com S.r.l.
Via Strada Nuova, 17
IT-31010 Mareno di Piave
TREVISO (Italy)
Phone +39.0438.30.91.31
Fax +39.0438.49.20.99
www.adfweb.com

