

User Manual

Revision 1.002

English

PROFINET / CANopen – Converter

(Order Code: HD67607-A1)

for Website information:

www.adfweb.com?Product=HD67607

for Price information:

www.adfweb.com?Price=HD67607-A1

Benefits and Main Features:

- ✦ Very easy to configure
- ✦ Wide supply input range
- ✦ Electrical isolation
- ✦ Industrial temperature range:



For others PROFINET products see also the following link:

Converter PROFINET to

www.adfweb.com?Product=HD67078
www.adfweb.com?Product=HD67090
www.adfweb.com?Product=HD67178
www.adfweb.com?Product=HD67600
www.adfweb.com?Product=HD67601
www.adfweb.com?Product=HD67602
www.adfweb.com?Product=HD67603
www.adfweb.com?Product=HD67604
www.adfweb.com?Product=HD67605
www.adfweb.com?Product=HD67606
www.adfweb.com?Product=HD67608
www.adfweb.com?Product=HD67609
www.adfweb.com?Product=HD67610
www.adfweb.com?Product=HD67611
www.adfweb.com?Product=HD67612
www.adfweb.com?Product=HD67613
www.adfweb.com?Product=HD67614
www.adfweb.com?Product=HD67615
www.adfweb.com?Product=HD67660
www.adfweb.com?Product=HD67679
www.adfweb.com?Product=HD67719
www.adfweb.com?Product=HD67818
www.adfweb.com?Product=HD67848
www.adfweb.com?Product=HD67952

(M-Bus)
(M-Bus Wireless)
(SNMP Manager)
(NMEA2000)
(RS232/RS485)
(Modbus Master)
(Modbus Slave)
(PROFIBUS Master)
(PROFIBUS Slave)
(CAN)
(DeviceNet Master)
(DeviceNet Slave)
(J1939)
(Modbus TCP Master)
(Modbus TCP Slave)
(SNMP Agent)
(DMX)
(NMEA 0183)
(EtherNet/IP Slave)
(BACnet Slave)
(BACnet Master)
(KNX)
(DALI)
(MQTT)

Do you have an your customer protocol?

www.adfweb.com?Product=HD67003

Do you need to choose a device? do you want help?

www.adfweb.com?Cmd=helpme



User Manual

INDEX:

	Page
INDEX	2
UPDATED DOCUMENTATION	2
REVISION LIST	2
WARNING	2
TRADEMARKS	2
SECURITY ALERT	3
EXAMPLE OF CONNECTION	4
CONNECTION SCHEME	5
CHARACTERISTICS	6
CONFIGURATION	6
POWER SUPPLY	7
FUNCTION MODES	8
LEDS	9
PROFINET	10
CANOPEN	11
USE OF COMPOSITOR SW67607	12
NEW PROJECT / OPEN PROJECT	13
SOFTWARE OPTIONS	14
SET COMMUNICATION	15
SET SDO SERVER	17
SET SDO CLIENT	18
SET PDO ACCESS	20
SET NODE GUARDING	22
RESTART DEVICES	23
PROFINET XML	24
EDS FILE	24
UPDATE DEVICE	25
SENDING ASYNCHRONOUS CAN MESSAGES	27
ASYN SDO REQUESTS	29
CANOPEN DIAGNOSTIC OVER PROFINET	30
MECHANICAL DIMENSIONS	31
ORDERING INFORMATIONS	32
ACCESSORIES	32
PLC CONFIGURATION	33
DISCLAIMER	36
OTHER REGULATIONS AND STANDARDS	36
WARRANTIES AND TECHNICAL SUPPORT	37
RETURN POLICY	37

UPDATED DOCUMENTATION:

Dear customer, we thank you for your attention and we remind you that you need to check that the following document is:

- Updated
- Related to the product you own

To obtain the most recently updated document, note the “document code” that appears at the top right-hand corner of each page of this document.

With this “Document Code” go to web page www.adfweb.com/download/ and search for the corresponding code on the page. Click on the proper “Document Code” and download the updates.

To obtain the updated documentation for the product that you own, note the “Document Code” (Abbreviated written "Doc. Code" on the label on the product) and download the updated from our web site www.adfweb.com/download/

REVISION LIST:

Revision	Date	Author	Chapter	Description
1.000	03/09/2012	Dp	All	First Release
1.001	29/07/2013	Fl	All	Revision
1.002	09/07/2018	Ff	All	Revision

WARNING:

ADFweb.com reserves the right to change information in this manual about our product without warning.
ADFweb.com is not responsible for any error this manual may contain.

TRADEMARKS:

All trademarks mentioned in this document belong to their respective owners.

SECURITY ALERT:**GENERAL INFORMATION**

To ensure safe operation, the device must be operated according to the instructions in the manual. When using the device are required for each individual application, legal and safety regulation. The same applies also when using accessories.

INTENDED USE

Machines and systems must be designed so the faulty conditions do not lead to a dangerous situation for the operator (i.e. independent limit switches, mechanical interlocks, etc.).

QUALIFIED PERSONNEL

The device can be used only by qualified personnel, strictly in accordance with the specifications. Qualified personnel are persons who are familiar with the installation, assembly, commissioning and operation of this equipment and who have appropriate qualifications for their job.

RESIDUAL RISKS

The device is state of the art and is safe. The instrument can represent a potential hazard if they are inappropriately installed and operated by personnel untrained. These instructions refer to residual risks with the following symbol:

 This symbol indicates that non-observance of the safety instructions is danger for people to serious injury or death and / or the possibility of damage.

CE CONFORMITY

The declaration is made by us. You can send an email to support@adfweb.com or give us a call if you need it.

EXAMPLE OF CONNECTION:

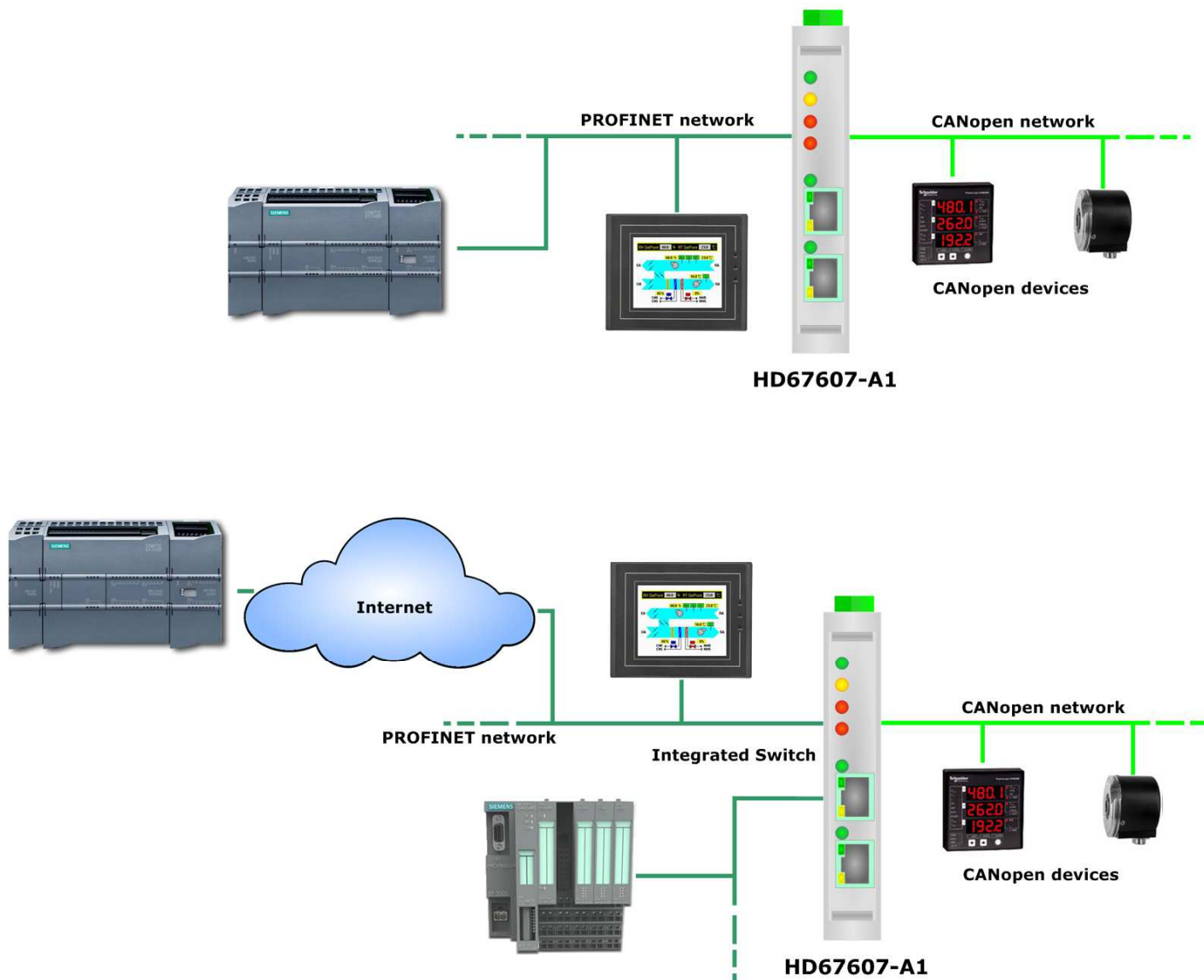

CONNECTION SCHEME:

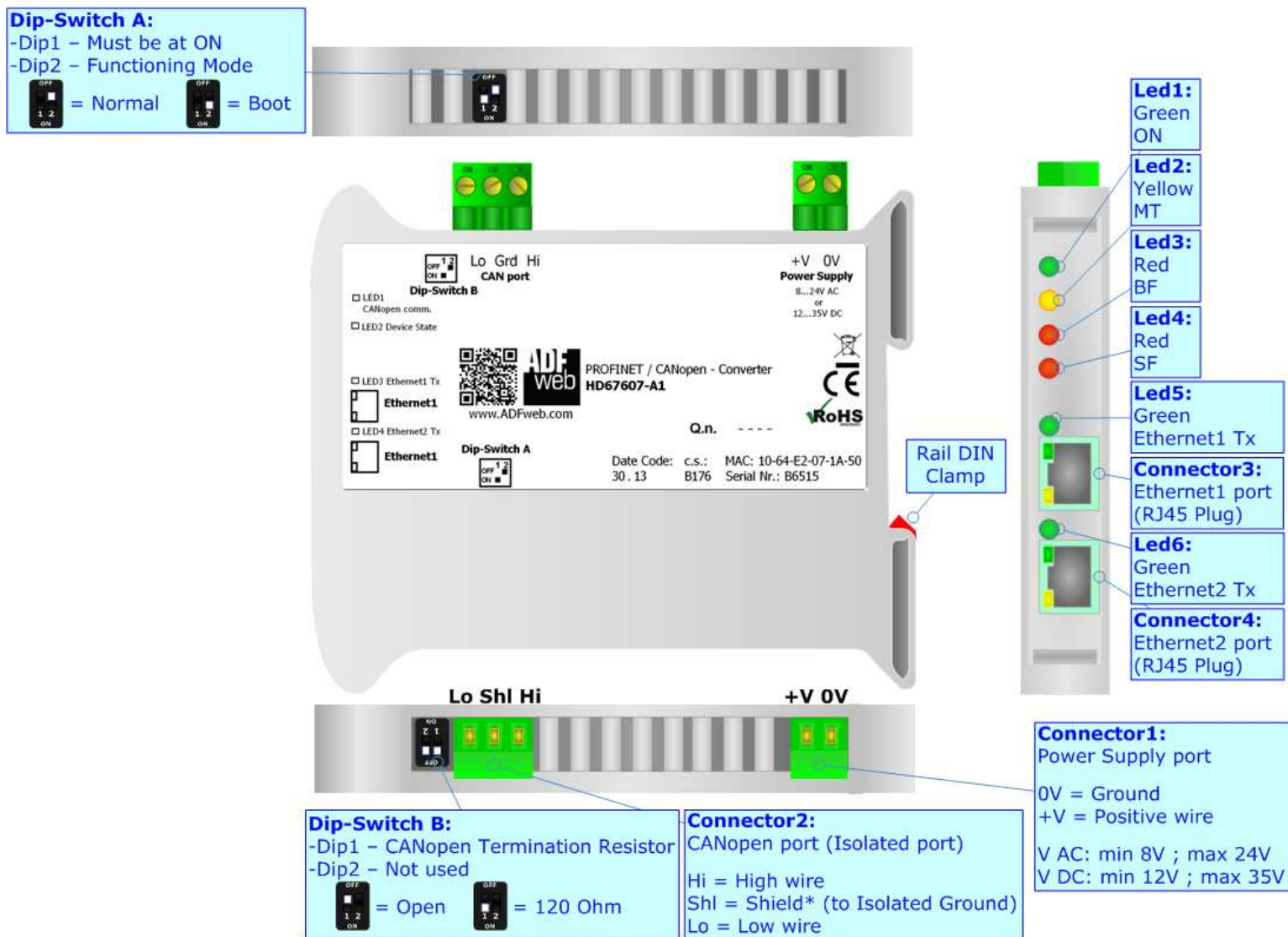

Figure 1: Connection scheme for HD67607-A1

CHARACTERISTICS:

The HD67607-A1 is a PROFINET / CANopen Converter.

It has the following characteristics:

- Up to 1440 bytes in reading and 1440 bytes in writing;
- Triple isolation between CAN - Power Supply, CAN - Ethernet, Power Supply - Ethernet.
- Two-directional information between CANopen bus and PROFINET bus;
- Mountable on 35mm Rail DIN;
- Wide power supply input range: 8...24V AC or 12...35V DC;
- Wide temperature range: -40°C / 85°C [-40°F / +185°F].

CONFIGURATION:

You need Compositor SW67607 software on your PC in order to perform the following:

- Define the parameter of PROFINET line;
- Define the parameter of CAN line;
- Define SDO Server information;
- Define SDO Client information;
- Define PDO information (RPDO/TPDO);
- Define Node Guarding;
- Update the device.

POWER SUPPLY:

The devices can be powered at 8...24V AC and 12...35V DC. For more details see the two tables below.

VAC 		VDC 	
Vmin	Vmax	Vmin	Vmax
8V	24V	12V	35V

Consumption at 24V DC:

Device	Consumption [W/VA]
HD67607-A1	3.5

Caution: Not reverse the polarity power

Connector1:
Power Supply port
0V = Ground
+V = Positive wire
V AC: min 8V ; max 24V
V DC: min 12V ; max 35V

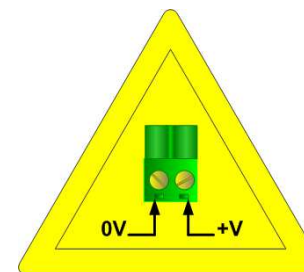
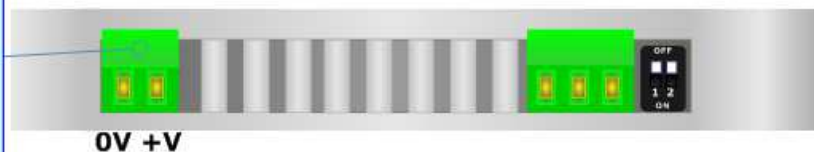

HD67607-A1

FUNCTION MODES:

The device has got two functions mode depending of the position of the 'Dip2 of Dip-Switch A':

- The first, with 'Dip2 of Dip-Switch A' at "OFF" position, is used for the normal working of the device.
- The second, with 'Dip2 of Dip-Switch A' at "ON" position, is used for upload the Project and/or Firmware.

For the operations to follow for the updating, see 'UPDATE DEVICE' section.

According to the functioning mode, the LEDs will have specifics functions, see 'LEDS' section.

**Warning:**

Dip1 of 'Dip-Switch A' must be at ON position for working even if the Ethernet cable isn't inserted.

LEDS:

The device has got six LEDs that are used to give information of the functioning status. The various meanings of the LEDs are described in the table below.

LED	Normal Mode	Boot Mode
1: ON [supply voltage] (green)	ON: Device powered OFF: Device not powered	ON: Device powered OFF: Device not powered
2: MT [maintenance display] (yellow)	ON: Maintenance Problem is present OFF: No maintenance are present	Blinks quickly: Boot state Blinks very slowly (~0.5Hz): update in progress
3: BF [bus fault] (red)	ON: The Ethernet connection is defective; the IP address exists several times in the network; the own NameOfStation exists several times in the network; no IP address has been set Flashing: At least one configured AR is no longer in the data exchange OFF: No errors are present	Blinks quickly: Boot state Blinks very slowly (~0.5Hz): update in progress
4: SF [group error] (red)	ON: At least one AR is not in the data exchange OFF: No errors are present	Blinks quickly: Boot state Blinks very slowly (~0.5Hz): update in progress
5: Ethernet1 Tx (green)	Blinks when is transmitting Ethernet frames	Blinks quickly: Boot state Blinks very slowly (~0.5Hz): update in progress
6: Ethernet2 Tx (green)	Blinks when is transmitting Ethernet frames	Blinks quickly: Boot state Blinks very slowly (~0.5Hz): update in progress

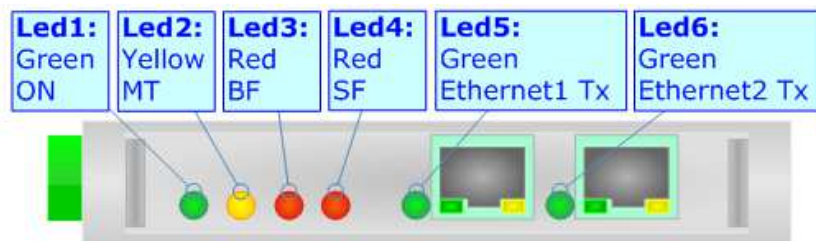

PROFINET:

The PROFINET connection must be made using Connector3 and/or Connector4 of HD67607-A1 with at least a Category 5E cable. The maximum length of the cable should not exceed 100m. The cable has to conform to the T568 norms relative to connections in cat.5 up to 100 Mbps. To connect the device to an Hub/Switch is recommended the use of a straight cable, to connect the device to a PC/PLC/other is recommended the use of a cross cable.

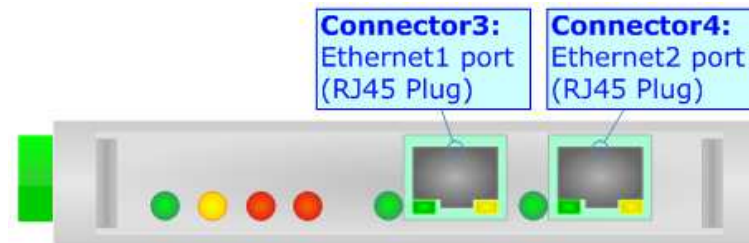

CANOPEN:

For terminate the CANopen line with a 120Ω resistor it is necessary that the Dip1 of 'Dip-Switch B' is at ON position.

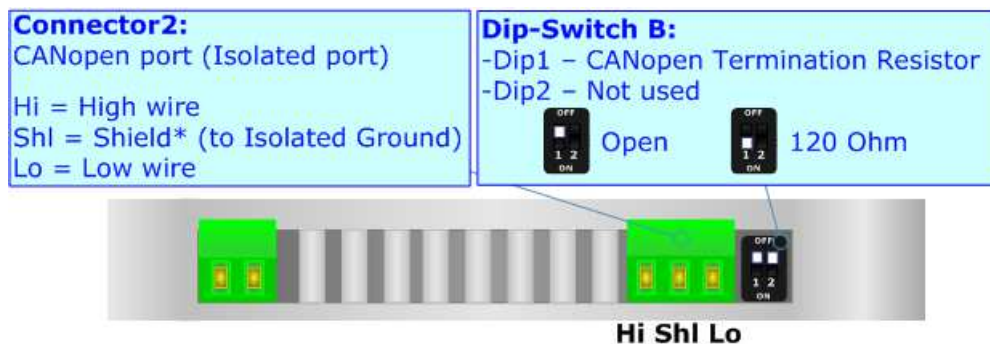

Cable characteristics:

DC parameter:	Impedance	70 Ohm/m
AC parameters:	Impedance	120 Ohm/m
	Delay	5 ns/m
Length	Baud Rate [bps]	Length MAX [m]
	10 K	5000
	20 K	2500
	50 K	1000
	100 K	650
	125 K	500
	250 K	250
	500 K	100
	800 K	50
	1000 K	25

USE OF COMPOSITOR SW67607:

To configure the Converter, use the available software that runs with Windows called SW67607. It is downloadable on the site www.adfweb.com and its operation is described in this document. *(This manual is referenced to the last version of the software present on our web site).* The software works with MSWindows (XP, Vista, Seven, 8, 10; 32/64bit).

When launching the SW67607, the window below appears (Fig. 2).



Note:

It is necessary to have installed .Net Framework 4.



Figure 2: Main window for SW67607

NEW CONFIGURATION / OPEN CONFIGURATION:

The “**New Configuration**” button creates the folder which contains the entire device’s configuration.

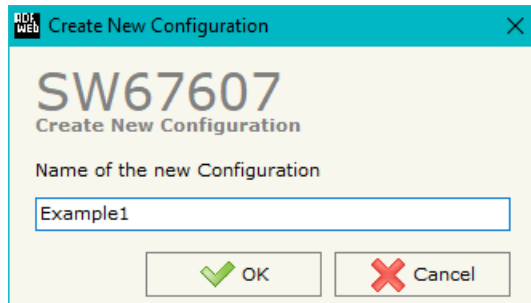

A device’s configuration can also be imported or exported:

- To clone the configurations of a programmable “PROFINET / CANopen - Converter” in order to configure another device in the same manner, it is necessary to maintain the folder and all its contents;
- To clone a project in order to obtain a different version of the project, it is sufficient to duplicate the project folder with another name and open the new folder with the button “**Open Configuration**”.

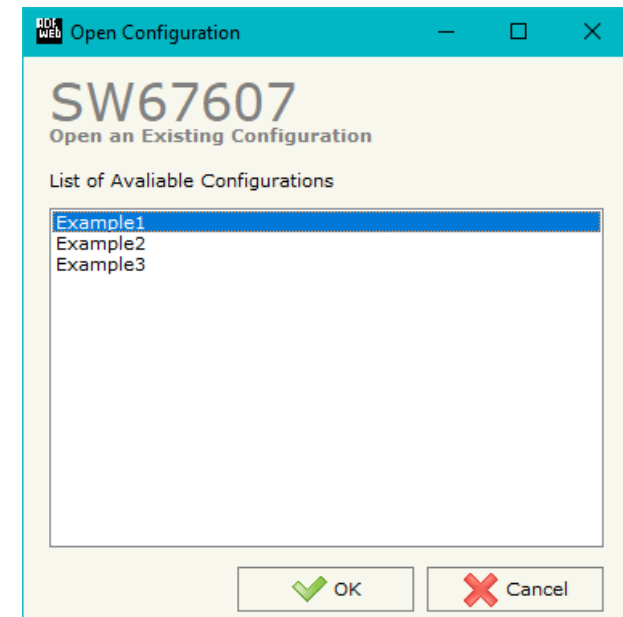

SOFTWARE OPTIONS:

By pressing the “**Settings**” () button there is the possibility to change the language of the software and check the updatings for the compositor.

In the section “Language” it is possible to change the language of the software.

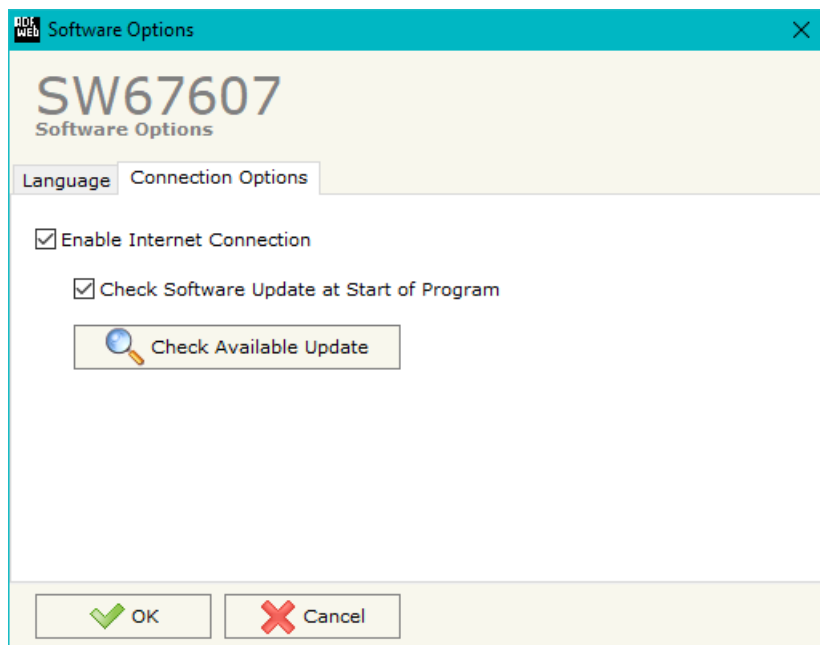

In the section “Connection Options”, it is possible to check if there are some updatings of the software compositor in ADFweb.com website. Checking the option “**Check Software Update at Start of Program**”, the SW67607 checks automatically if there are updatings when it is launched.

SET COMMUNICATION:

This section define the fundamental communication parameters of two buses, CANopen and PROFINET.

By Pressing the **"Set Communication"** button from the main window of SW67607 (Fig. 2) the window "Set Communication" appears (Fig. 3).

The meaning of the fields of "PROFINET" are:

- In the field **"IP ADDRESS"** the IP address to assign to the converter is defined;
- In the field **"SUBNET Mask"** the SubNet Mask of the converter is defined;
- In the field **"GATEWAY"** the default gateway of the network is defined. This feature can be enabled or disabled pressing the Check Box field. This feature is used for going out of the net;
- In the field **"Tunneling Port"** the port to use for the "Tunneling mode" is defined (see page 28 for more details);
- In the field **"PROFINET Name of Station"** the name of PROFINET side of the converter is defined;
- In the field **"PROFINET -> Gateway"** the number of byte from the PROFINET Master to the converter is defined (it is possible to use up to 1439 byte);
- In the field **"PROFINET <- Gateway"** the number of byte from the converter to the PROFINET Master is defined (it is possible to use up to 1439 byte);
- If the field **"Diagnostic"** is checked, the diagnostic function is enabled. In the field on the right, the starting PROFINET byte where saving the diagnostic is defined (see page 30 for more details);
- If the field **"CANopen CMD Ind"** is checked, It is possible to send asynchronous CAN messages from PROFINET (see page 27 for more details).

The means of the fields for the "CANopen" section are:

- In the field **"Device ID"** the ID of the CANopen side is defined;
- In the field **"Baud Rate"** the data rate of the CANopen line is defined;
- In the field **"Set Operational State at Start-Up"** the state of the CANopen is defined. I.e. If it is checked the board starts in Operational State, else it starts in Pre-Operational;
- In the field **"Network Start at Start-Up"** the state of the CANopen network is defined. I.e. If it is checked the board sends a command to set the Operational State of all the devices present in the network, after the time defined in the "Delay" field;

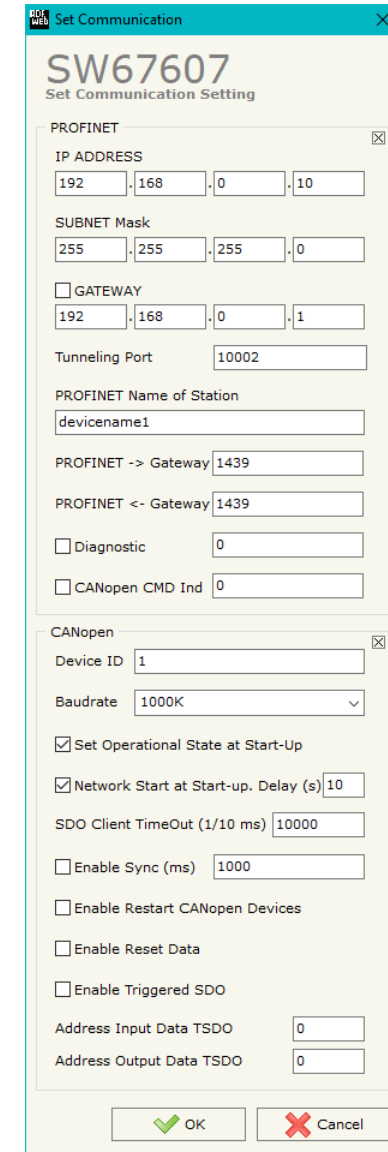

Figure 3: "Set Communication" window

- In the field "**Delay (s)**" the delay before sending the "Start" command for the CANopen is defined;
- In the field "**SDO Client TimeOut (1/10 ms)**" the maximum time that the device attends for the answer from the Slave interrogated is defined;
- If the field "**Enable Sync (ms)**" is checked and a time is defined, the converter can send cyclically a SYNC message to the CANopen network;
- If the field "**Enable Restart CANopen Devices**" is checked, the converter restarts the CANopen devices listed in the section "ReStart Devices" that are not answering to the NodeGuarding;
- If the field "**Enable Reset Data**" is checked, the converter resets data on PROFINET side for the CANopen devices that are not answering to NodeGuarding;
- If the field "**Enable Triggered SDO**" is checked, the it is possible to send asynchronous SDO requests directly from PROFINET side. The starting input byte of the converter to write for sending the SDO requests is defined in the field "**Address Input Data TSDO**" and the response is saved starting from output byte defined in the field "**Address Output Data TDSO**". See page 29 for more info.

SET SDO SERVER:

By pressing the **"Set SDO Server"** button from the main window for SW67607 (Fig. 2) the window "Set SDO Server Access" appears (Fig. 4).

This window is made to create the SDO in read or write in the CANopen side, and to indicate which byte are associated to these SDOs.

It is divided in two parts, the "SDO in read" and the "SDO in Write".

The first part is used to read, using the SDO, the data arrived from the PROFINET Master. The second is used to write, using SDO, the data that will be sent to the PROFINET Master.

The data of the columns have the following meanings:

- In the field **"Index"** the address of the SDO is defined;
- In the field **"SubIndex"** the second address of the SDO is defined;
- In the field **"N Byte"** the dimension of the SDO is defined (it can be 1, 2 or 4);
- In the field **"Address Byte1"** insert the address of the PROFINET arrays where read/write first byte of the SDO;
- In the field **"Address Byte2"** insert the address of the PROFINET arrays where read/write second byte of the SDO (only if N Byte is 2 or 4);
- In the field **"Address Byte3"** insert the address of the PROFINET arrays where read/write third byte of the SDO (only if N Byte is 4);
- In the field **"Address Byte4"** insert the address of the PROFINET arrays where read/write fourth byte of the SDO (only if N Byte is 4);
- In the field **"Mnemonic"** the description for the SDO is defined.

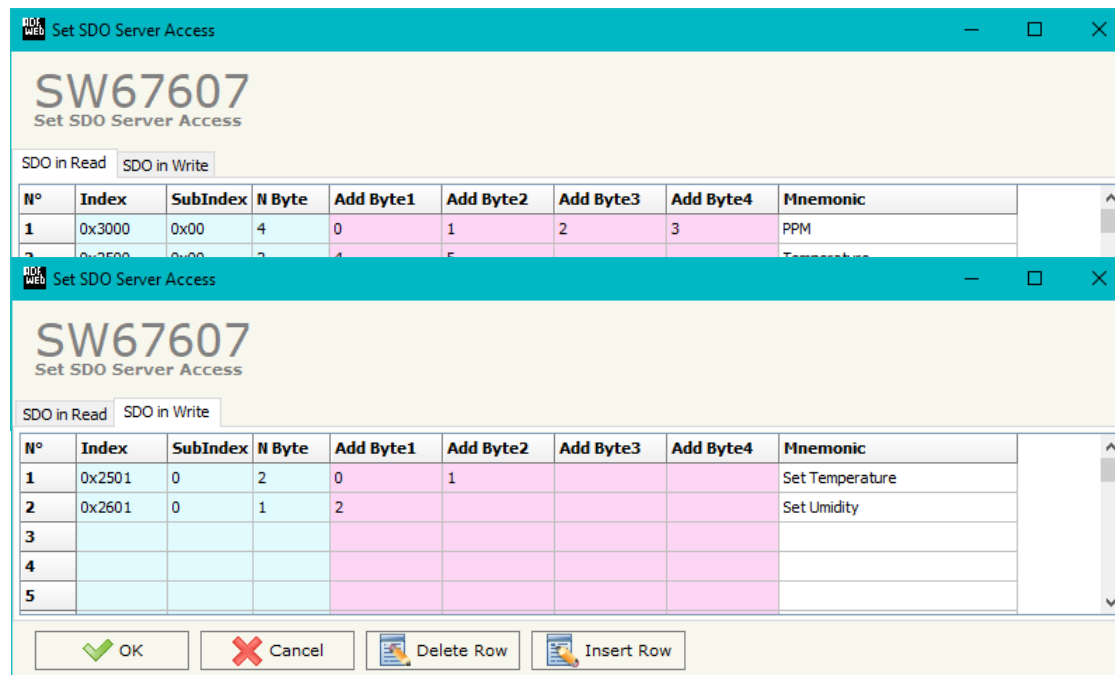

Figure 4: "Set SDO Server Access" window

SET SDO CLIENT:

By pressing the "Set SDO Client" button from the main window for SW67607 (Fig. 2) the window "Set SDO Client Access" appears (Fig. 5a and 5b).

With the SDO Client the HD67607 Gateway can read and/or write the data from other devices connected in the network CANopen.

It is divided in two parts, the "SDO Read" and the "SDO Write". The first part is used to read, using the SDO, the data in another device and then put them in the PROFINET array. The second part is used to write, using the SDO, the data present in the PROFINET array to others CANopen devices.

The data of the columns in the "SDO Read" have the following meanings:

- In the field "Device ID" insert the ID of the device to read;
- In the field "Index" the address for the SDO is defined;
- In the field "SubIndex" the second address for the SDO is defined;
- In the field "N Byte" the dimension of the SDO is defined (it can be 1, 2, or 4);
- In the field "Poll Time" insert the cyclic time to make this request;
- In the field "Address Byte1" the address of the PROFINET array where copying the first byte of the SDO read is defined;
- In the field "Address Byte2" the address of the PROFINET array where copying the second byte of the SDO read is defined (only if N Byte is 2 or 4);
- In the field "Address Byte3" the address of the PROFINET array where copying the third byte of the SDO read is defined (only if N Byte is 4);
- In the field "Address Byte4" the address of the PROFINET array where copying the fourth byte of the SDO read is defined (only if N Byte is 4);
- In the field "Mnemonic" the description for the SDO is defined.

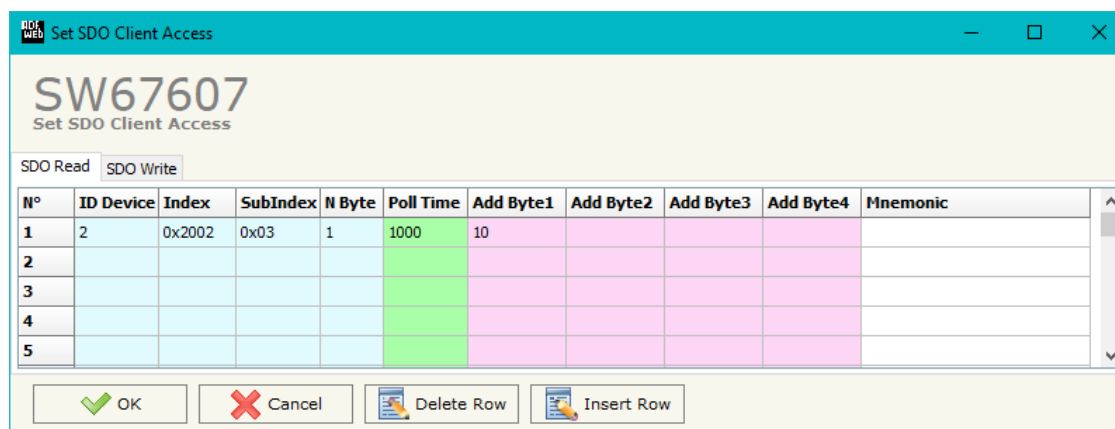

Figure 5a: "Set SDO Client Access – SDO Read" window

The data of the columns in the "SDO Write" have the following meanings:

- In the field "**Device ID**" insert the ID of the device to write;
- In the field "**Index**" the address for the SDO is defined;
- In the field "**SubIndex**" the second address for the SDO is defined;
- In the field "**N Byte**" the dimension of the SDO is defined (it can be 1, 2, or 4);
- In the field "**Poll Time**" insert the cyclic time to make this request;
- If the field "**On Change**" is checked, the gateway sends the Write SDO request when the data change the value;
- In the field "**Address Byte1**" the address of the PROFINET array where reading the first byte of the SDO write is defined;
- In the field "**Address Byte2**" the address of the PROFINET array where reading the second byte of the SDO write is defined (only if N Byte is 2 or 4);
- In the field "**Address Byte3**" the address of the PROFINET array where reading the third byte of the SDO write is defined (only if N Byte is 4);
- In the field "**Address Byte4**" the address of the PROFINET array where reading the fourth byte of the SDO write is defined (only if N Byte is 4);
- In the field "**Mnemonic**" the description for the SDO is defined.

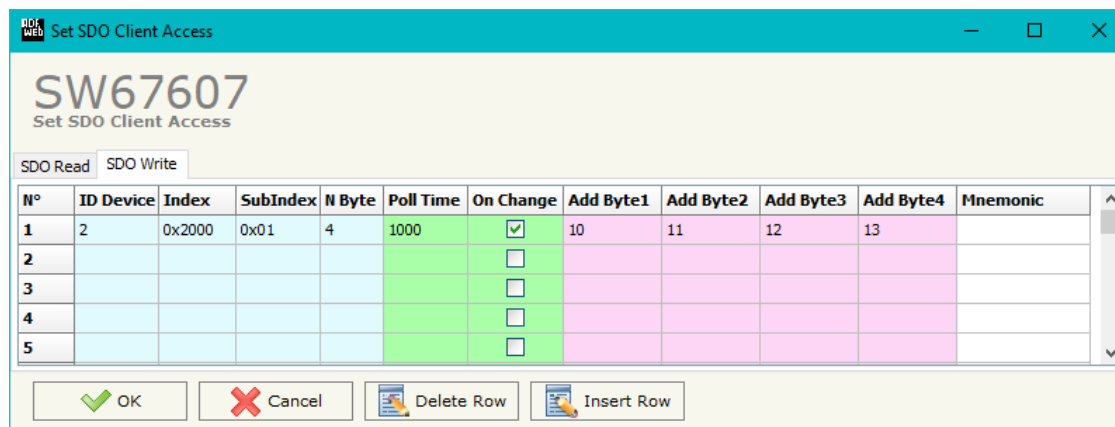

Figure 5b: "Set SDO Client Access – SDO Write" window

SET PDO ACCESS:

By pressing the "Set PDO Access" button from the main window for SW67607 (Fig. 2) the window "Set PDO Access" appears (Fig. 6a and 6b).

This window is made to create the Receive and the Transmit PDO in the CANopen side, and to indicate which bytes are associated to these PDO.

It is divided in two parts, the "Receive PDO" and the "Transmit PDO". The first part is used to receive PDO in the CANopen network and copy the data in the PROFINET array. The second part is used to transmit PDO in the CANopen network with the data of PROFINET array.

The data of the columns in the "Receive PDO" have the following meanings:

- In the Field "**Cob-ID**" the address for the PDO is defined;
- In the Field "**Dimension**" the dimension of the PDO is defined (it can be between 1 and 8);
- In the Field "**Add B1**" the first byte where the data will be saved in the PROFINET array is defined;
- In the Field "**Add B2**" the second byte where the data will be saved in the PROFINET array is defined (only if **Dimension** > 1);
- In the Field "**Add B3**" the third byte where the data will be saved in the PROFINET array is defined (only if **Dimension** > 2);
- In the Field "**Add B4**" the fourth byte where the data will be saved in the PROFINET array is defined (only if **Dimension** > 3);
- In the Field "**Add B5**" the fifth byte where the data will be saved in the PROFINET array is defined (only if **Dimension** > 4);
- In the Field "**Add B6**" the sixth byte where the data will be saved in the PROFINET array is defined (only if **Dimension** > 5);
- In the Field "**Add B7**" the seventh byte where the data will be saved in the PROFINET array is defined (only if **Dimension** > 6);
- In the Field "**Add B8**" the eighth byte where the data will be saved in the PROFINET array is defined (only if **Dimension** > 7);
- The field "**TimeOut**" is used for put at zero the data into PROFINET if the PDO doesn't arrive with a frequency less than the time expressed in the field. If the value in the field is 0, it means that you don't want to use this feature, and so the value is never deleted;
- In the field "**Mnemonic**" the description for the PDO is defined.

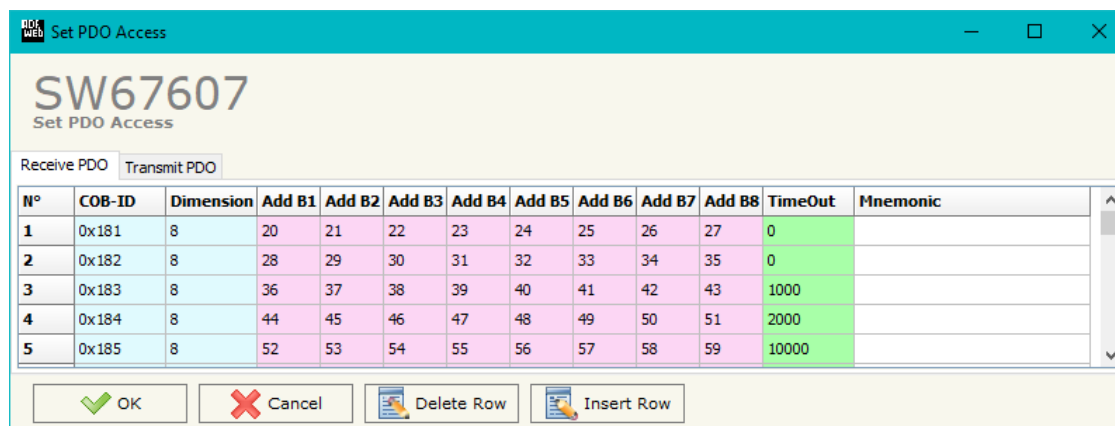

N°	COB-ID	Dimension	Add B1	Add B2	Add B3	Add B4	Add B5	Add B6	Add B7	Add B8	TimeOut	Mnemonic
1	0x181	8	20	21	22	23	24	25	26	27	0	
2	0x182	8	28	29	30	31	32	33	34	35	0	
3	0x183	8	36	37	38	39	40	41	42	43	1000	
4	0x184	8	44	45	46	47	48	49	50	51	2000	
5	0x185	8	52	53	54	55	56	57	58	59	10000	

Figure 6a: "Set PDO Access – Receive PDO" window

The data of the columns in the "Transmit PDO" have the following meanings:

- In the Field "**Cob-ID**" the address for the PDO is defined;
- In the Field "**Dimension**" the dimension of the PDO is defined (it can be between 1 and 8);
- In the Field "**Add B1**" the first byte where the data will be loaded in the PROFINET array is defined;
- In the Field "**Add B2**" the second byte where the data will be loaded in the PROFINET array is defined (only if **Dimension** > 1);
- In the Field "**Add B3**" the third byte where the data will be loaded in the PROFINET array is defined (only if **Dimension** > 2);
- In the Field "**Add B4**" the fourth byte where the data will be loaded in the PROFINET array is defined (only if **Dimension** > 3);
- In the Field "**Add B5**" the fifth byte where the data will be loaded in the PROFINET array is defined (only if **Dimension** > 4);
- In the Field "**Add B6**" the sixth byte where the data will be loaded in the PROFINET array is defined (only if **Dimension** > 5);
- In the Field "**Add B7**" the seventh byte where the data will be loaded in the PROFINET array is defined (only if **Dimension** > 6);
- In the Field "**Add B8**" the eighth byte where the data will be loaded in the PROFINET array is defined (only if **Dimension** > 7);
- In the Field "**Send Time**" insert the interval used to send the PDO. The time is in milliseconds;
- If the field "**On Change**" is checked, the gateway send the Transmit PDO when the data change the value;
- In the field "**Mnemonic**" the description for the PDO is defined.

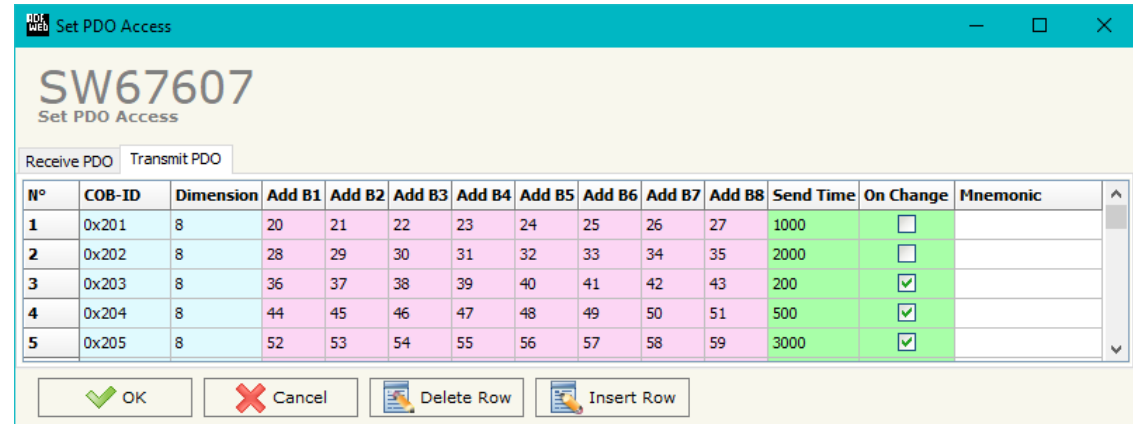
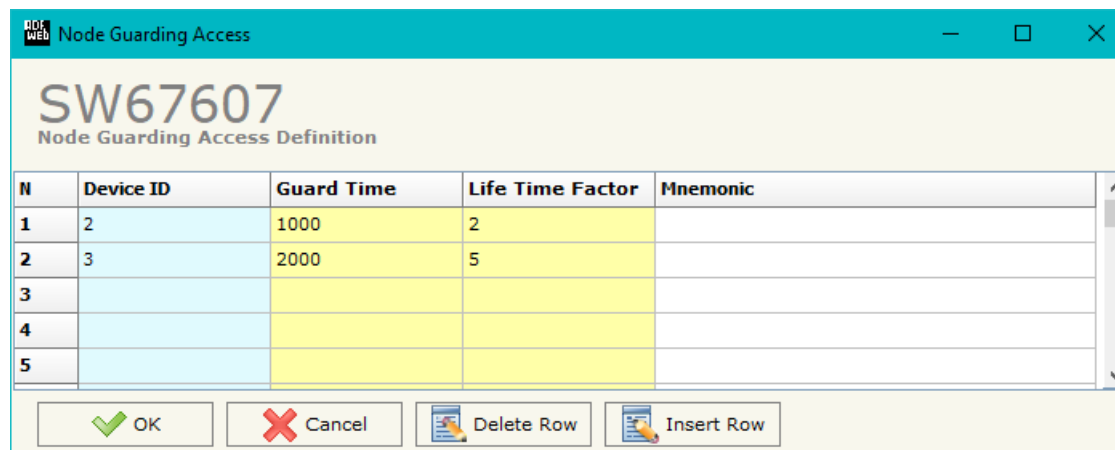

Figure 6b: "Set PDO Access – Transmit PDO" window

SET NODE GUARDING

N	Device ID	Guard Time	Life Time Factor	Mnemonic
1	2	1000	2	
2	3	2000	5	
3				
4				
5				

Figure 7: "Node Guarding Access Definition" window

By pressing the "**Set Node Guarding**" button from the Main Window of SW67607 (Fig. 2) the "Node Guarding Access Definition" window appears (Fig. 7).

The data of the columns have the following meanings:

- In the field "**Device ID**" the address of the device that you want to control is defined;
- In the field "**Guard Time**" the Guard Time is defined. This value indicates the delay between two interrogations;
- In the field "**Life Time Factor**" the number of attempts before considering the device absent is defined;
- In the field "**Mnemonic**" a description is defined.

RESTART DEVICES

Figure 8: "ReStart CANopen Devices" window

By pressing the "**ReStart Devices**" button from the Main Window of SW67607 (Fig. 2) the "ReStart CANopen Devices" window appears (Fig. 8). This section is used to define which CANopen devices the converter will try to restart if they are not responding to Node Guard.

The data of the columns have the following meanings:

- In the field "**Enable ReStart**" it is possible to select which CANopen devices the converter will restart;
- In the field "**Mnemonic**" a description is defined.

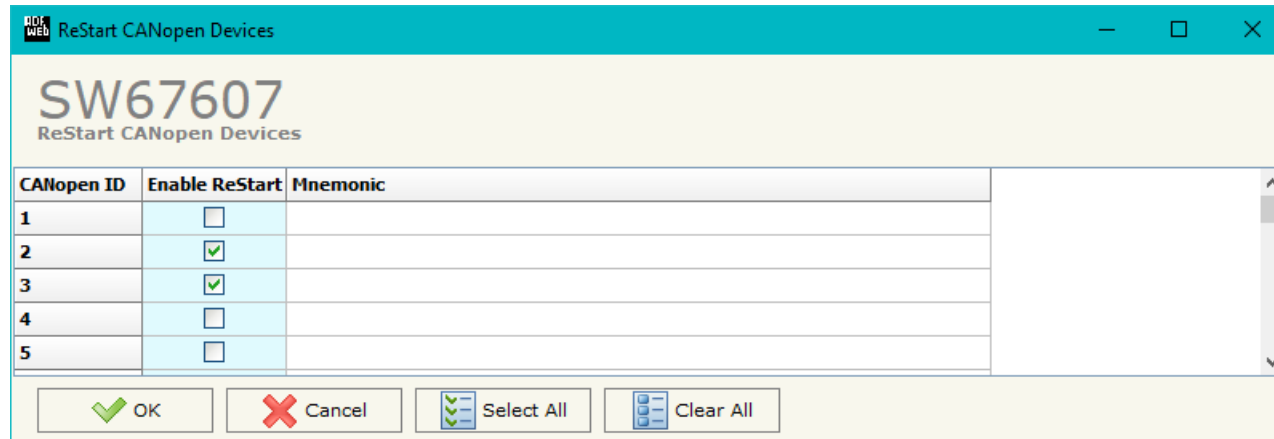
PROFINET XML:

By Pressing the "**PROFINET XML**" button from the main window for SW67607 (Fig. 2) it is possible to generate the xml file to be imported into the master PROFINET.

EDS FILE:

By Pressing the "**EDS FILE**" button from the main window for SW67607 (Fig. 2) it is possible to generate the EDS file to be imported into the master CANopen.

UPDATE DEVICE:

By pressing the **“Update Device”** button it is possible to load the created Configuration into the device; and also the Firmware, if is necessary.

If you don't know the actual IP address of the device you have to use this procedure:

- Turn OFF the Device;
- Put Dip2 of 'Dip-Switch A' at ON position;
- Turn ON the device
- Connect the Ethernet cable;
- Insert the IP **“192.168.2.205”**;
- Press the **“Ping”** button, must appear **“Device Found!”**;
- Press the **“Next”** button;
- Select which operations you want to do;
- Press the **“Execute update firmware”** button to start the upload;
- When all the operations are **“OK”** turn OFF the Device;
- Put Dip2 of 'Dip-Switch A' at OFF position;
- Turn ON the device.

If you know the actual IP address of the device you have to use this procedure:

- Turn ON the Device with the Ethernet cable inserted;
- Insert the actual IP of the Converter;
- Press the **“Ping”** button, must appear **“Device Found!”**;
- Press the **“Next”** button;
- Select which operations you want to do;
- Press the **“Execute update firmware”** button to start the upload;
- When all the operations are **“OK”** the device automatically goes at Normal Mode.

At this point the configuration/firmware on the device is correctly update.

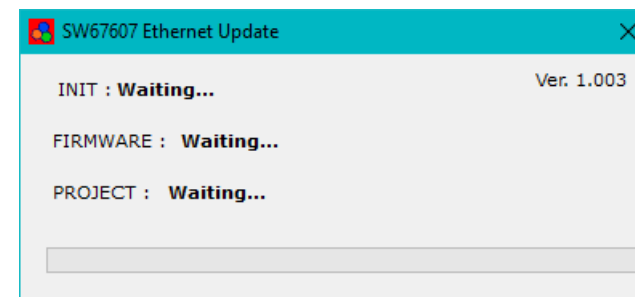
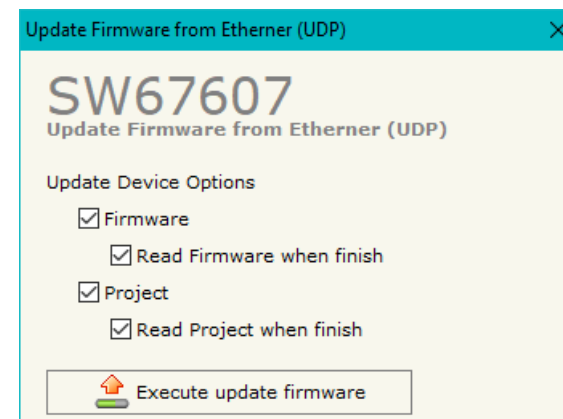
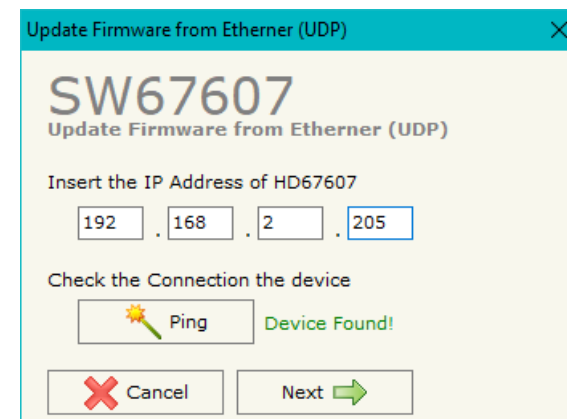

Figure 9: "Update device" windows

**Note:**

When you install a new version of the software, if it is the first time it is better you do the update of the Firmware in the HD67607 device.

**Note:**

When you receive the device, for the first time, you also have to update the Firmware in the HD67607 device.

**Warning:**

If Fig. 10 appears when you try to do the Update try these points before seeking assistance:

- Try to repeat the operations for the updating;
- Try with another PC;
- Try to restart the PC;
- Check the LAN settings;
- Check the Wi-Fi settings;
- If you are using the program inside a Virtual Machine, try to use in the main Operating System;
- If you are using Windows Seven, Vista, 8 or 10 make sure that you have the administrator privileges;
- In case you have to program more than one device, using the "UDP Update", you have to cancel the ARP table every time you connect a new device on Ethernet. For do this you have to launch the "Command Prompt" and write the command "arp -d". Pay attention that with Windows Vista, Seven, 8, 10 you have to launch the "Command Prompt" with Administrator Rights;
- Pay attention at Firewall lock.

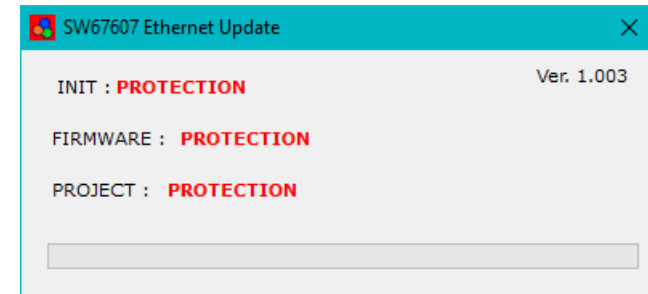

Figure 10: Error window



In the case of HD67607 you have to use the software "SW67607": www.adfweb.com/download/filefold/SW67607.zip.

SENDING ASYNCHRONOUS CAN MESSAGES

The converter allows to send asynchronous CAN messages (for example a NMT message) directly from Ethernet to CANopen. To send the Ethernet frame to the converter, there are two different ways:

- ➔ Using the PROFINET;
- ➔ Using the tunneling port of the converter.

MODE 1: PROFINET

In this case, to send a CAN message from Ethernet to CANopen, it is necessary to enable the option "CANopen CMD Ind" in the section "Set Communication". It is necessary to write the bytes of PROFINET side starting from the first one defined in this way:

Byte Number	Description
1	Counter (increased to send the new CAN message)
2	Number of bytes to send
3÷6	COB-ID of CAN message
7÷14	Data

To choose the type of CAN (2.0A or 2.0B) of the frame that the converter will send, it is necessary to put the most significant bit of the byte 1 to:

- 0: CAN 2.0A;
- 1: CAN 2.0B.

MODE 2: TUNNELING PORT

In this case, to send a CAN message from Ethernet to CANopen, it is necessary to send an UDP message to the Tunneling port of the converter.

The Ethernet message to send to the converter must have this structure:

Byte Number	Description
1÷4	COB-ID of the CAN message to send
5÷(4+n)	Data of the CAN message

n=Number of Byte to Write

To choose the type of CAN (2.0A or 2.0B) of the frame that the converter will send, it is necessary to put the most significant bit of the byte 1 to:

- 0: CAN 2.0A;
- 1: CAN 2.0B.

Example:

We want to send the NMT message "Start" to the CANopen device 5. The Ethernet frame will have these characteristics:
 CAN Type=2.0A; Frame: Cob_ID=0x0000; Data=0x0105.

So the string of hexadecimal numbers to be send to the converter is: [00][00][00][00][01][05].

ASYNCR SDO REQUESTS:

The converter allows to send asynchronous SDO requests directly from PROFINET to CANopen. This function can be enabled by checking the option "Enable Triggered SDO" in the section "Set Communication".

It is necessary to write the bytes of PROFINET side starting from the first byte defined in the field "Address Output Data TDSO" in this way:

Byte Number	Description
1	Counter (increased to send the new CAN message)
2	ID of the CANopen node to interrogate
3÷4	Index of SDO
5	SubIndex of SDO
6÷9	Data to write (set to '0' in case of reading request)
10	Most Significant bit → 0: W; 1: R Bit 6, 5, 4, 3, 2, 1, 0 → Number of bytes to write

The feedback of the SDO request is saved from the first byte defined in the field "Address Input Data TDSO" in this way:

Byte Number	Description
1÷4	Data read (in case of reading)
5	Status of request (1 → OK; 2 → Not OK)

CANOPEN DIAGNOSTIC OVER PROFINET:

It is possible to save the CANopen Diagnostic on PROFINET array using the field "Diagnostic" of the section "Set Communication". The status of each CANopen node defined in the section "Set Node Guarding" is saved starting from the byte of the PROFINET array defined in the section "Set Communication". There will be 127 bytes reserved.

The status of the CANopen nodes can be different in relation to their state:

- 0x04: Node in Stop state;
- 0x7F: Node in Pre-Operational state;
- 0x05: Node in Operational state.

MECHANICAL DIMENSIONS:

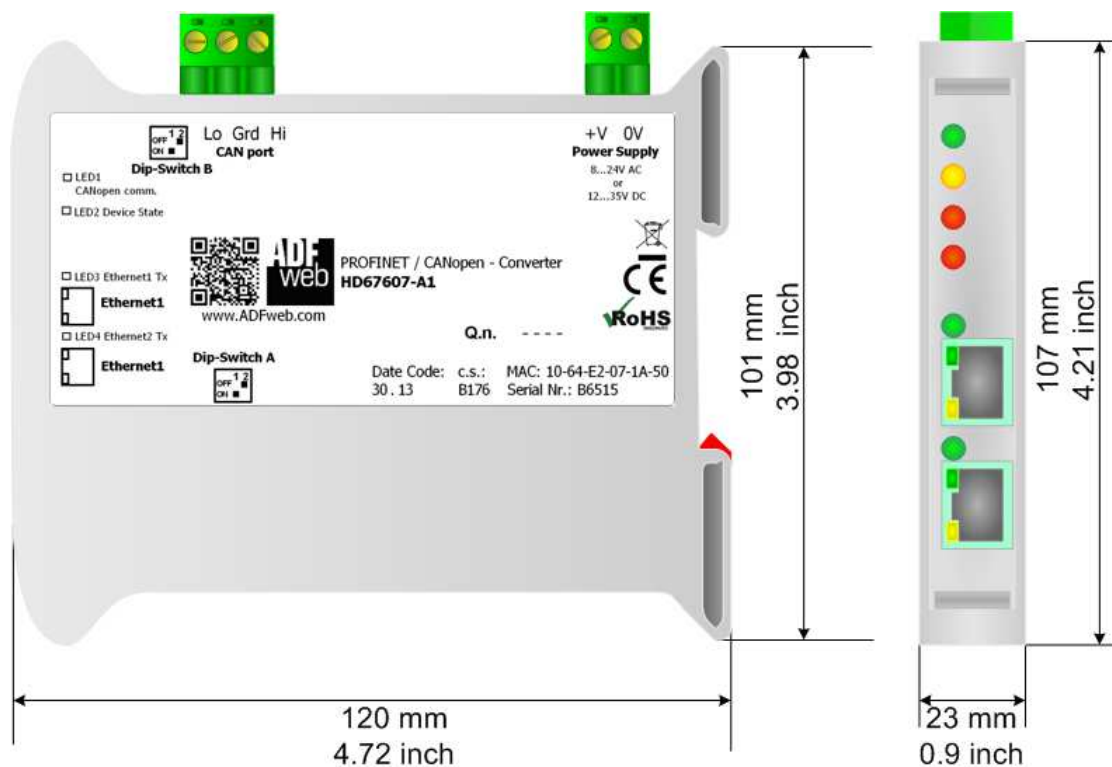

Housing: PVC
Weight: 200g (Approx)

Figure 11: Mechanical dimensions scheme for HD67607-A1

ORDERING INFORMATIONS:

The ordering part number is formed by a valid combination of the following:

HD67607 - A 1



Order Code: **HD67607-A1** - PROFINET / CANopen - Converter

ACCESSORIES:

Order Code: **AC34001** - 35mm Rail DIN - Power Supply 220/240V AC 50/60Hz - 12 V AC

Order Code: **AC34002** - 35mm Rail DIN - Power Supply 110V AC 50/60Hz - 12 V AC

PLC CONFIGURATION:

The configuration and commissioning of the PROFINET Converter as described on the following pages was accomplished with the help of the TIA Portal V11-software of Siemens. In case of using a control system from another supplier please attend to the associated documentation. These are the steps to follow:

- 1) Install the description file of the module.

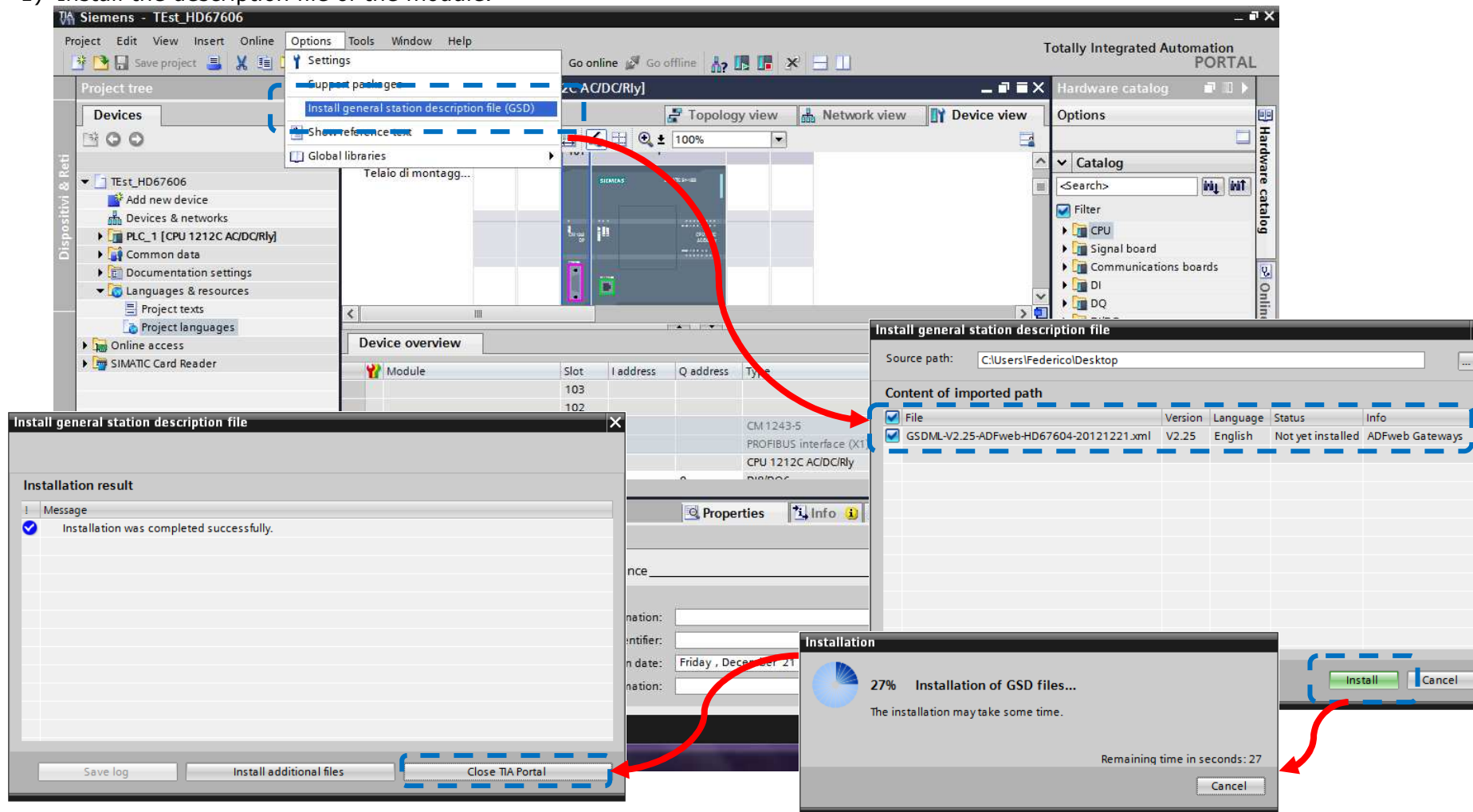

2) Import the module in the network; connect the device to the PLC network and edit the parameters of IP, station name etc.

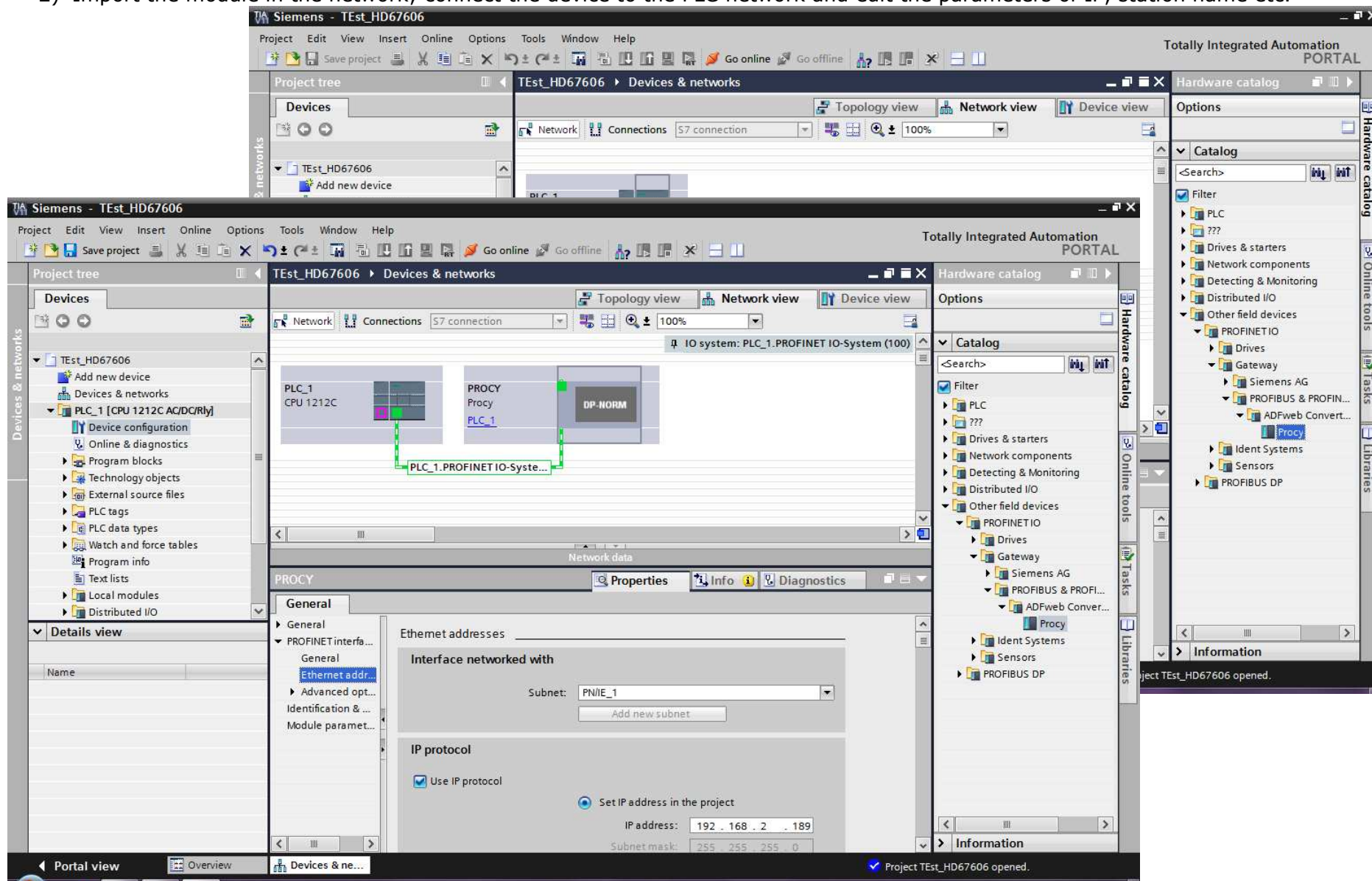

3) Load the configuration into the PLC.

Configured access nodes of "PLC_1"

Device	Device type	Type	Address	Subnet
PLC_1	CPU 1212C AC/D...	PN/IE	192.168.2.50	PN/IE_1
CM 1243-5	CM 1243-5	PROFIBUS	2	

Type of the PG/PC interface:

PG/PC interface:

Connection to subnet:

1st gateway:

Accessible devices in target subnet: Show all accessible devices

Device	Device type	Type	Address	Target device
PLC_1	CPU 1212C AC/D...	PN/IE	192.168.2.50	PLC_1
--	--	PN/IE	Access address	--

Flash LED

Online status information:
 Connected to address 192.168.2.50
 Scanning ended.

Buttons: Refresh, Load, Cancel

Load preview

? Check before loading

Status	!	Target	Message	Action
+	<input checked="" type="checkbox"/>	PLC_1	Ready for loading.	
	<input checked="" type="checkbox"/>	▶ Stop modules	All modules will be stopped for downloading to device.	Stop all
	<input checked="" type="checkbox"/>	▶ Device configurati...	Delete and replace system data in target	Download to device
	<input checked="" type="checkbox"/>	▶ Software	Download software to device	Consistent download
	<input checked="" type="checkbox"/>	▶ Additional inform...	There are differences between the settings for the project and the se	<input checked="" type="checkbox"/> Overwrite all

Buttons: Refresh, Finish, Load, Cancel

DISCLAIMER

All technical content within this document can be modified without notice. The content of the document content is a recurring audit. For losses due to fire, earthquake, third party access or other accidents, or intentional or accidental abuse, misuse, or use under abnormal conditions repairs are charged to the user. ADFweb.com S.r.l. will not be liable for accidental loss of use or inability to use this product, such as loss of business income. ADFweb.com S.r.l. shall not be liable for consequences of improper use.

OTHER REGULATIONS AND STANDARDS

WEEE INFORMATION



Disposal of old electrical and electronic equipment (as in the European Union and other European countries with separate collection systems).

— This symbol on the product or on its packaging indicates that this product may not be treated as household rubbish. Instead, it should be taken to an applicable collection point for the recycling of electrical and electronic equipment. If the product is disposed correctly, you will help prevent potential negative environmental factors and human health, which could otherwise be caused by inappropriate disposal. The recycling of materials will help to conserve natural resources. For more information about recycling this product, please contact your local city office, your household waste disposal service or the shop where you purchased the product.

RESTRICTION OF HAZARDOUS SUBSTANCES DIRECTIVE



The device respects the 2002/95/EC Directive on the restriction of the use of certain hazardous substances in electrical and electronic equipment (commonly referred to as Restriction of Hazardous Substances Directive or RoHS).

CE MARKING



The product conforms with the essential requirements of the applicable EC directives.

WARRANTIES AND TECHNICAL SUPPORT:

For fast and easy technical support for your ADFweb.com SRL products, consult our internet support at www.adfweb.com.
Otherwise contact us at the address support@adfweb.com

RETURN POLICY:

If while using your product you have any problem and you wish to exchange or repair it, please do the following:

- 1) Obtain a Product Return Number (PRN) from our internet support at www.adfweb.com. Together with the request, you need to provide detailed information about the problem.
- 2) Send the product to the address provided with the PRN, having prepaid the shipping costs (shipment costs billed to us will not be accepted).

If the product is within the warranty of twelve months, it will be repaired or exchanged and returned within three weeks. If the product is no longer under warranty, you will receive a repair estimate.