

# User Manual

Revision 1.001  
English

## PROFINET / NMEA 0183 - Converter

(Order Code: HD67615-A1, HD67615-422-A1)

for Website information:

[www.adfweb.com?Product=HD67615](http://www.adfweb.com?Product=HD67615)

for Price information:

[www.adfweb.com?Price=HD67615-A1](http://www.adfweb.com?Price=HD67615-A1)

[www.adfweb.com?Price=HD67615-422-A1](http://www.adfweb.com?Price=HD67615-422-A1)

### Benefits and Main Features:

- ✦ Very easy to configure
- ✦ 32mm Rail DIN mount
- ✦ Wide supply input range
- ✦ Temperature range: -40°C/+85°C (-40°F/+185°F)

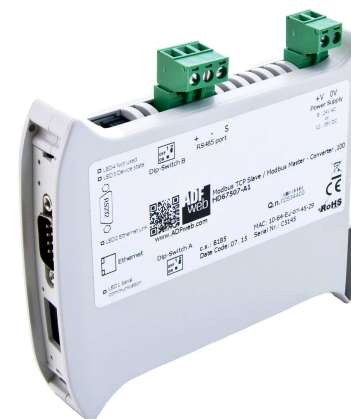

User Manual

For other Gateways / Bridges:

### Serial / Modbus TCP - converter

See also the following links:

[www.adfweb.com?product=HD67521](http://www.adfweb.com?product=HD67521) (Modbus TCP Slave)

### CAN bus to Modbus

See also the following links:

[www.adfweb.com?product=HD67011](http://www.adfweb.com?product=HD67011) (Modbus RTU Master)

[www.adfweb.com?product=HD67012](http://www.adfweb.com?product=HD67012) (Modbus RTU Slave)

[www.adfweb.com?product=HD67514](http://www.adfweb.com?product=HD67514) (Modbus TCP Master)

[www.adfweb.com?product=HD67515](http://www.adfweb.com?product=HD67515) (Modbus TCP Server)

Do you have an your customer protocol?

See the following links:

[www.adfweb.com?Product=HD67003](http://www.adfweb.com?Product=HD67003)

Do you need to choose a device? do you want help?

Ask it to the following link:

[www.adfweb.com?Cmd=helpme](http://www.adfweb.com?Cmd=helpme)

**INDEX:**

	Page
INDEX	2
UPDATED DOCUMENTATION	2
REVISION LIST	2
WARNING	2
TRADEMARKS	2
SECURITY ALERT	3
EXAMPLE OF CONNECTION	4
CONNECTION SCHEME	5
CHARACTERISTICS	7
CONFIGURATION	7
POWER SUPPLY	8
FUNCTION MODES	9
LEDS	10
RS485	11
RS422	12
RS232	13
ETHERNET	14
USE OF COMPOSITOR SW67615	15
NEW PROJECT / OPEN PROJECT	16
SOFTWARE OPTIONS	17
SET COMMUNICATION	19
RECEIVE FRAMES	22
PROFINET XML	23
OBJECTS MAP	23
UPDATE DEVICE	24
MECHANICAL DIMENSIONS	26
ORDER CODES	27
ACCESSORIES	27
DISCLAIMER	28
OTHER REGULATIONS AND STANDARDS	28
WARRANTIES AND TECHNICAL SUPPORT	29
RETURN POLICY	29

**UPDATED DOCUMENTATION:**

Dear customer, we thank you for your attention and we remind you that you need to check that the following document is:

- Updated
- Related to the product you own

To obtain the most recently updated document, note the “document code” that appears at the top right-hand corner of each page of this document.

With this “Document Code” go to web page [www.adfweb.com/download/](http://www.adfweb.com/download/) and search for the corresponding code on the page. Click on the proper “Document Code” and download the updates.

**REVISION LIST:**

Revision	Date	Author	Chapter	Description
1.000	15/06/2017	Ff	All	First release version
1.001	29/04/2020	Ff	All	Added RS422 version

**WARNING:**

ADFweb.com reserves the right to change information in this manual about our product without warning. ADFweb.com is not responsible for any error this manual may contain.

**TRADEMARKS:**

All trademarks mentioned in this document belong to their respective owners.

**SECURITY ALERT:****GENERAL INFORMATION**

To ensure safe operation, the device must be operated according to the instructions in the manual. When using the device are required for each individual application, legal and safety regulation. The same applies also when using accessories.

**INTENDED USE**

Machines and systems must be designed so the faulty conditions do not lead to a dangerous situation for the operator (i.e. independent limit switches, mechanical interlocks, etc.).

**QUALIFIED PERSONNEL**

The device can be used only by qualified personnel, strictly in accordance with the specifications.

Qualified personnel are persons who are familiar with the installation, assembly, commissioning and operation of this equipment and who have appropriate qualifications for their job.

**RESIDUAL RISKS**

The device is state of the art and is safe. The instrument can represent a potential hazard if they are inappropriately installed and operated by personnel untrained. These instructions refer to residual risks with the following symbol:

 This symbol indicates that non-observance of the safety instructions is danger for people to serious injury or death and / or the possibility of damage.

**CE CONFORMITY**

The declaration is made by us. You can send an email to [support@adfweb.com](mailto:support@adfweb.com) or give us a call if you need it.

**EXAMPLE OF CONNECTION:**

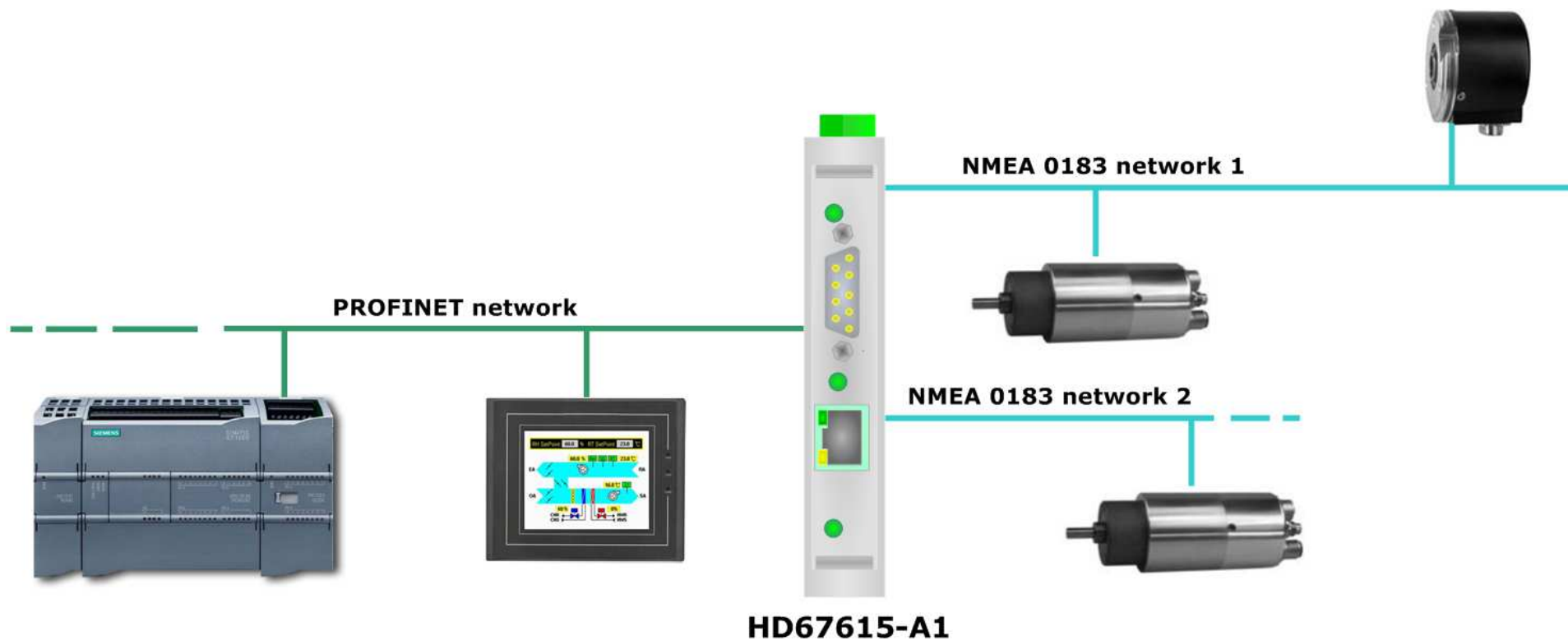

 **ADFweb.com srl**  
 tel. +39 - 0438.30.91.31  
[www.adfweb.com](http://www.adfweb.com)  
[info@adfweb.com](mailto:info@adfweb.com)

**CONNECTION SCHEME:**

**Dip-Switch A:**  
 -Dip1 - Must be at ON  
 -Dip2 - Functioning Mode  
 [OFF] = Normal [ON] = Boot

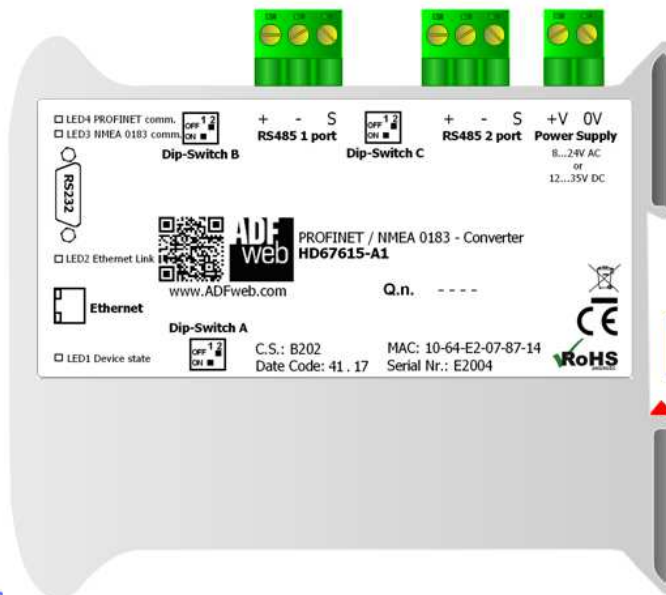

**Connector 4:**  
 RS232 Port (D-SUB9-Male)  
 (Isolated Port)  
 PIN2 = RX  
 PIN3 = TX  
 PIN5 = GND\* (to Isolated Ground)  
 Used for:  
 - Programming Port  
 - Modbus on RS232  
 To connect the device to the COM port of a PC in order to set it you have to use the programming cable AC34107 or a cable made as showed here:

**Led4:**  
 Green  
 PROFINET communication  
**Led3:**  
 Green  
 NMEA 0183 communication  
**Led2:**  
 Green  
 Ethernet Link  
**Connector5:**  
 Ethernet Port (RJ45 Plug)  
**Led1:**  
 Green  
 Device state

Rail DIN Clamp

**Dip-Switch B:**  
 -Dip1 - RS485 Termination Resistor  
 [OFF] = Open [ON] = 120 Ohm  
 -Dip2 - Not used



**Connector1:**  
 Power Supply port  
 0V = Ground  
 +V = Positive wire  
 V AC: min 8V ; max 24V  
 V DC: min 12V ; max 35V

**Connector3:**  
 RS485 1 Port (Isolated port)  
 S = Shield\* (to Isolated Ground)  
 B = Negative wire  
 A = Positive wire

**Dip-Switch C:**  
 -Dip1 - RS485 Termination Resistor  
 [OFF] = Open [ON] = 120 Ohm  
 -Dip2 - Not used

**Connector2:**  
 RS485 2 Port (Isolated port)  
 S = Shield\* (to Isolated Ground)  
 B = Negative wire  
 A = Positive wire

Figure 1a: Connection scheme for HD67615-A1

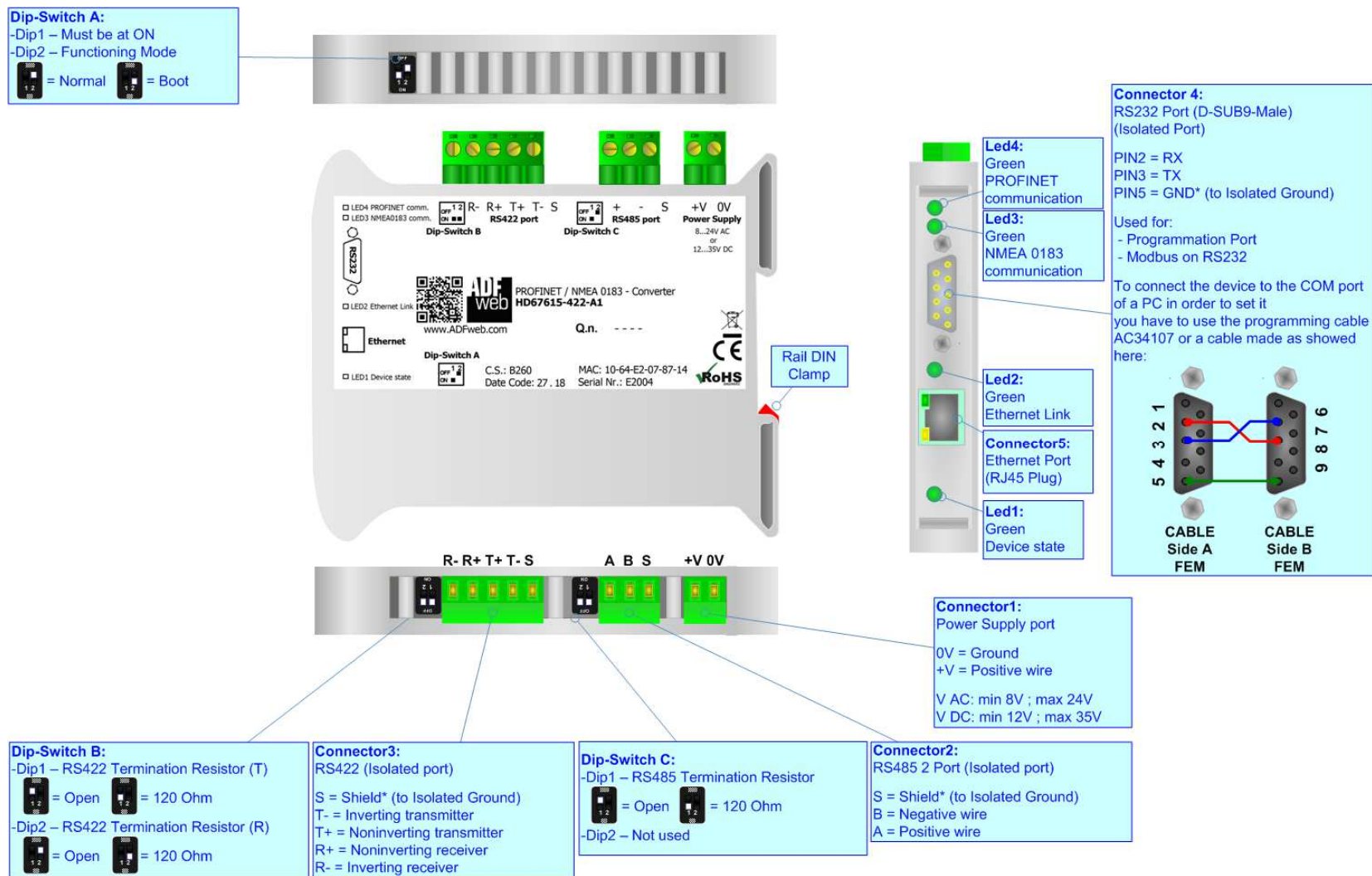

Figure 1b: Connection scheme for HD67615-422-A1

**CHARACTERISTICS:**

The "PROFINET / NMEA 0183 - Converter" allows the following characteristics:

- electrical isolation between NMEA 0183 – PROFINET, Power Supply – PROFINET, Power Supply – NMEA 0183;
- Multiple independent NMEA 0183 lines;
- Mountable on Rail DIN;
- Wide power supply input range: 8...24V AC or 12...35V DC;
- Wide temperature range: -40°C / 85°C [-40°F / +185°F].

**CONFIGURATION:**

You need Compositor SW67615 software on your PC in order to perform the following:

- Define the parameter of NMEA 0183;
- Define the parameter of PROFINET;
- Define the list of NMEA 0183 sentences in reception;
- Update the device.

**POWER SUPPLY:**

The devices can be powered at 8...24V AC and 12...35V DC. The consumption depends to the code of the device. For more details see the two tables below.

VAC		VDC	
Vmin	Vmax	Vmin	Vmax
8V	24V	12V	35V

Consumption at 24V DC:

Device	Consumption [W/VA]
HD67615-xxx-A1	3.5

**Caution: Not reverse the polarity power**

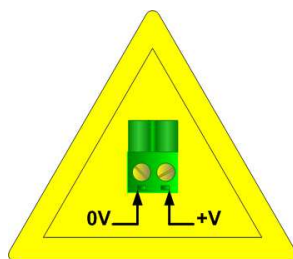

HD67615-A1

**Connector1:**  
 Power Supply port  
 0V = Ground  
 +V = Positive wire  
 V AC: min 8V ; max 24V  
 V DC: min 12V ; max 35V





**FUNCTION MODES:**

The device has got two function modes depending on the position of the 'Dip2 of Dip-Switch A':

- The first, with 'Dip2 of Dip-Switch A' at "OFF" position, is used for the normal working of the device.
- The second, with 'Dip2 of Dip-Switch A' at "ON" position, is used for uploading the Project and/or Firmware.

For the operations to follow for the updating, see 'UPDATE DEVICE' section.

According to the functioning mode, the LEDs will have specific functions, see 'LEDS' section.

**Warning:**

Dip1 of 'Dip-Switch A' must be at ON position to work even if the Ethernet cable is not inserted.

**LEDS:**

The device has got four LEDs that are used to give information of the functioning status. The various meanings of the LEDs are described in the table below.

LED	Normal Mode	Boot Mode
1: Device State (green)	Blinks slowly (~1Hz)	<b>Blinks quickly:</b> Boot state <b>Blinks very slowly (~0.5Hz):</b> update in progress
2: Ethernet Link (green)	<b>ON:</b> Ethernet cable connected <b>OFF:</b> Ethernet cable disconnected	<b>ON:</b> Ethernet cable connected <b>OFF:</b> Ethernet cable disconnected
3: NMEA 0183 communication (green)	Blinks when NMEA 0183 frames are received	<b>Blinks quickly:</b> Boot state <b>Blinks very slowly (~0.5Hz):</b> update in progress
4: PROFINET communication (green)	Blinks when PROFINET communication is running	<b>Blinks quickly:</b> Boot state <b>Blinks very slowly (~0.5Hz):</b> update in progress



**RS485:**

For terminate the RS485 line with a 120Ω resistor it is necessary to put ON dip 1, like in figure.

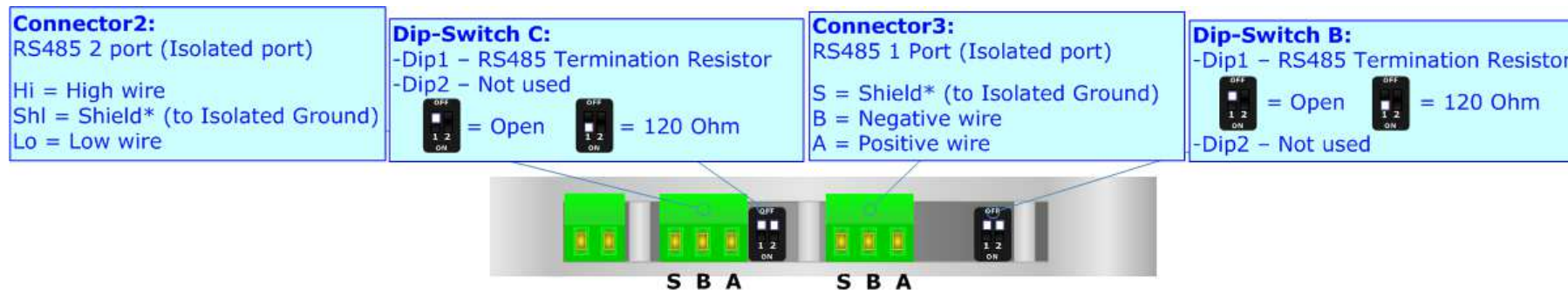

The maximum length of the cable should be 1200m (4000 feet).

Here some codes of cables:

- Belden: p/n 8132 - 2x 28AWG stranded twisted pairs conductor + foil shield + braid shield;
- Belden p/n 82842 - 2x 24AWG stranded twisted pairs conductor + foil shield + braid shield;
- Tasker: p/n C521 - 1x 24AWG twisted pair conductor + foil shield + braid shield;
- Tasker: p/n C522 - 2x 24AWG twisted pairs conductor + foil shield + braid shield.

**RS422:**

For terminating the RS422 line with a 120Ω resistor it is necessary to put ON dip 1 for T line and/or put ON dip 2 for R line, like in figure.

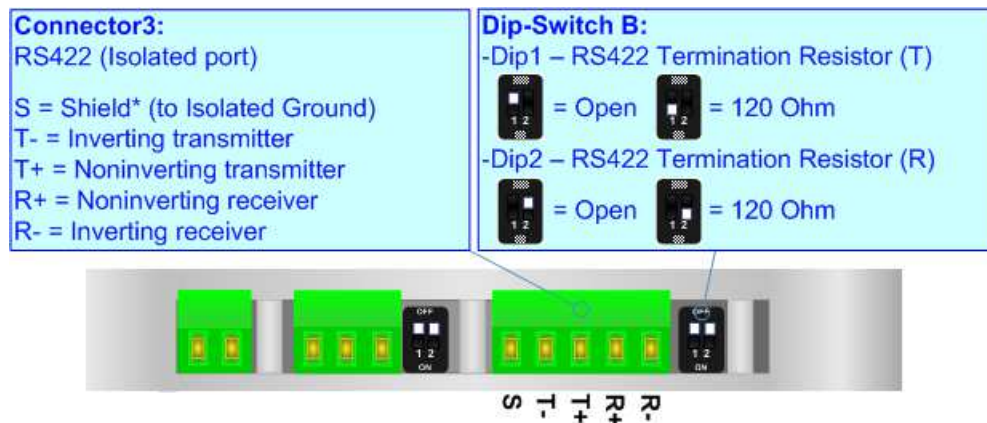

The maximum length of the cable should be 1200m (4000 feet).

**RS232:**

The connection from RS232 socket to a serial port must be made with a Null Modem cable (a serial cable where the pins 2 and 3 are crossed).  
It is recommended that the RS232 cable not exceed 15 meters.

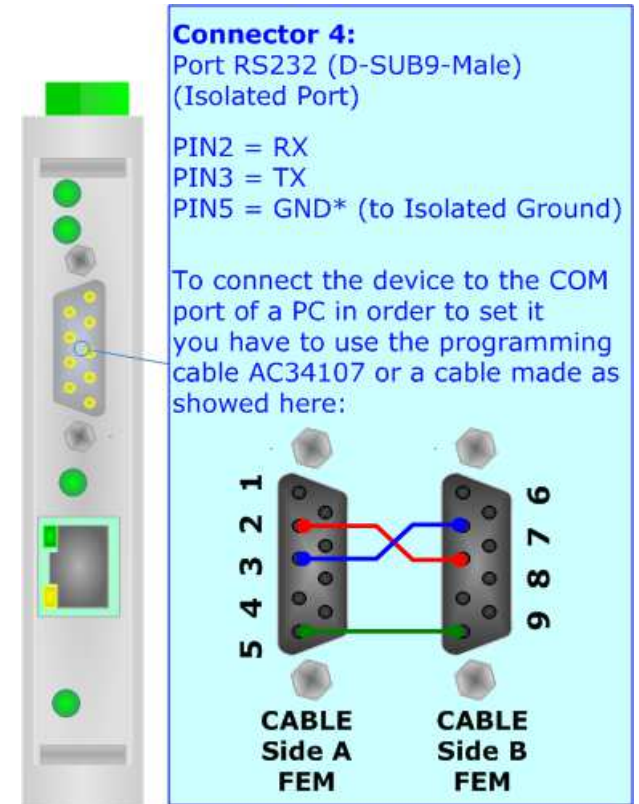

**ETHERNET:**

The Ethernet connection must be made using Connector5 of HD67615 with at least a Category 5E cable. The maximum length of the cable should not exceed 100m. The cable has to conform to the T568 norms relative to connections in cat.5 up to 100 Mbps. To connect the device to a Hub/Switch the use of a straight cable is recommended. To connect the device to a PC/PLC/other the use of a cross cable is recommended.

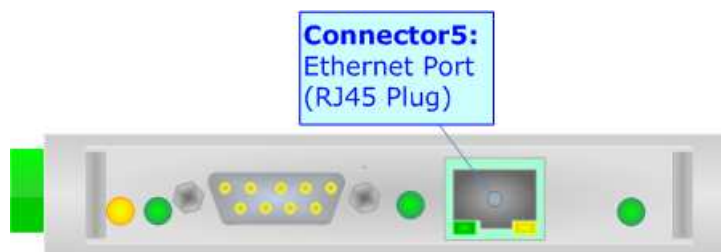

### USE OF COMPOSITOR SW67615:

To configure the Converter, use the available software that runs with Windows called SW67615. It is downloadable on the site [www.adfweb.com](http://www.adfweb.com) and its operation is described in this document. *(This manual is referenced to the last version of the software present on our web site)*. The software works with MSWindows (XP, Vista, Seven, 8, 10; 32/64bit).

When launching the SW67615, the window below appears (Fig. 2).



**Note:**

It is necessary to have installed .Net Framework 4.

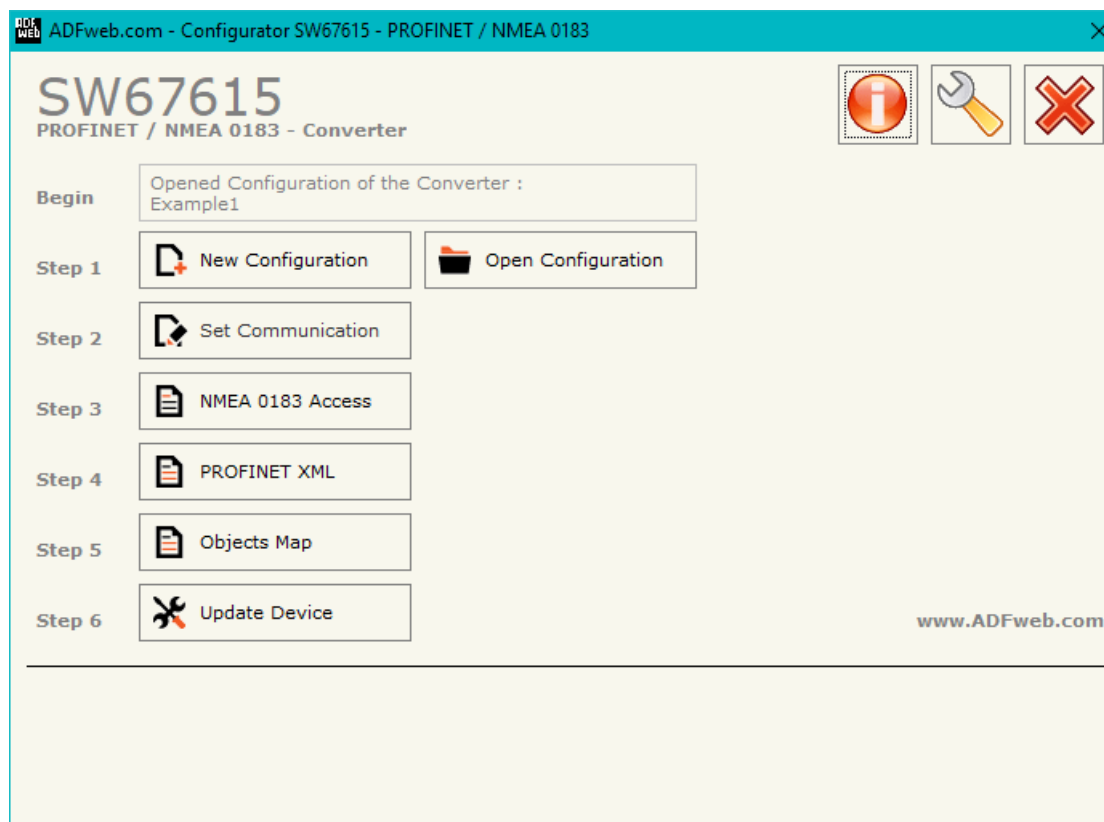
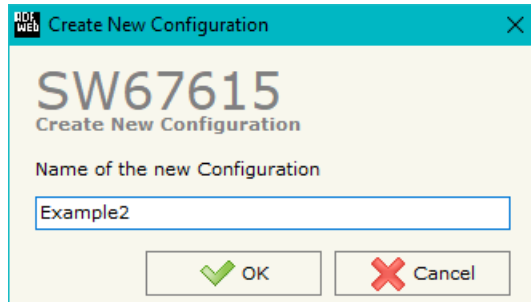

Figure 2: Main window for SW67615

**NEW CONFIGURATION / OPEN CONFIGURATION:**

The “**New Configuration**” button creates the folder which contains the entire device’s configuration.



A device’s configuration can also be imported or exported:

- To clone the configurations of a programmable “PROFINET / NMEA 0183 - Converter” in order to configure another device in the same manner, it is necessary to maintain the folder and all its contents;
- To clone a project in order to obtain a different version of the project, it is sufficient to duplicate the project folder with another name and open the new folder with the button “**Open Configuration**”.

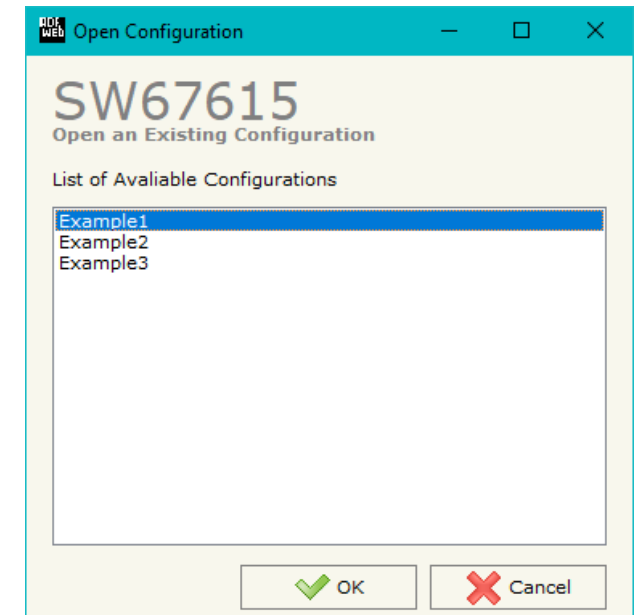



**SOFTWARE OPTIONS:**

By pressing the “**Settings**” () button there is the possibility to change the language of the software and check the updatings for the compositor.

In the section “Language” it is possible to change the language of the software.

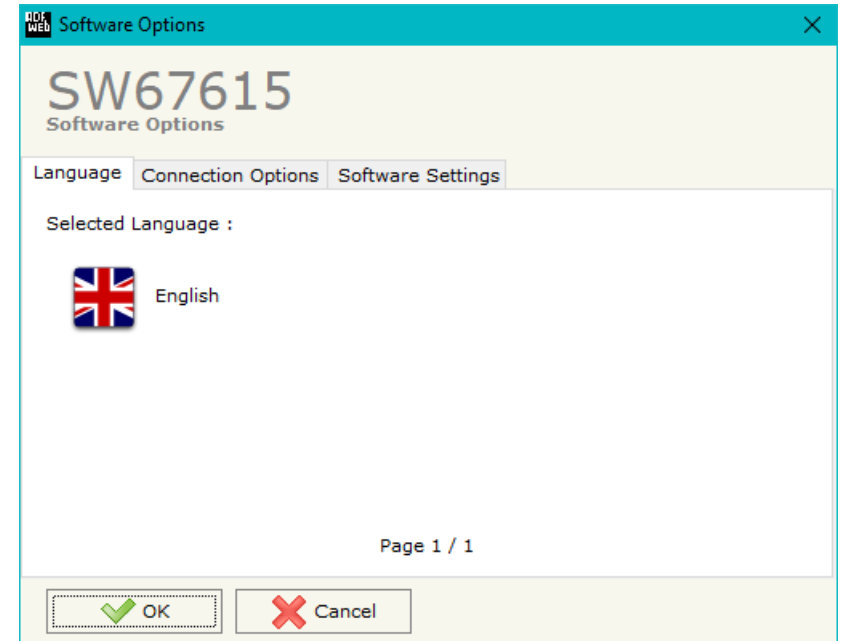
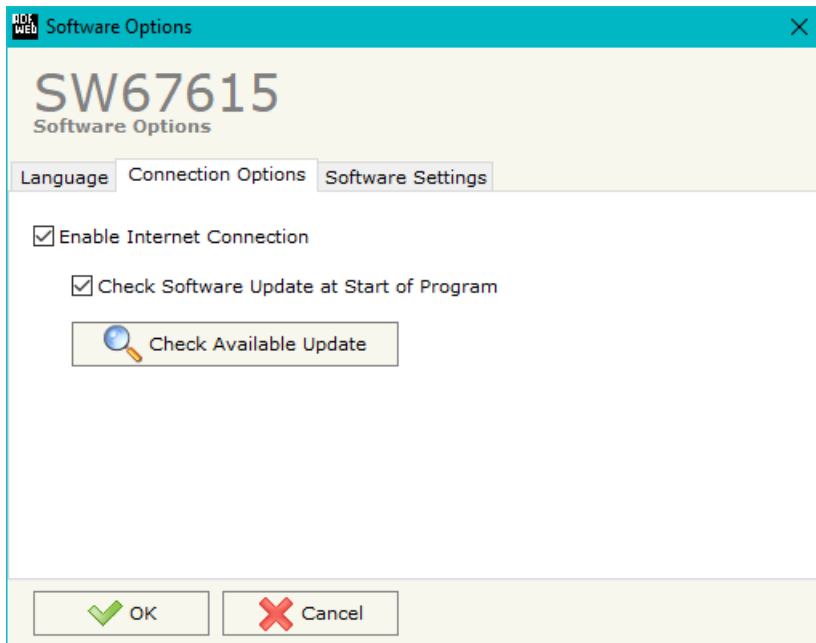

In the section “Connection Options”, it is possible to check if there are some updatings of the software compositor in ADFweb.com website. Checking the option “**Check Software Update at Start of Program**”, the SW67615 check automatically if there are updatings when it is launched.

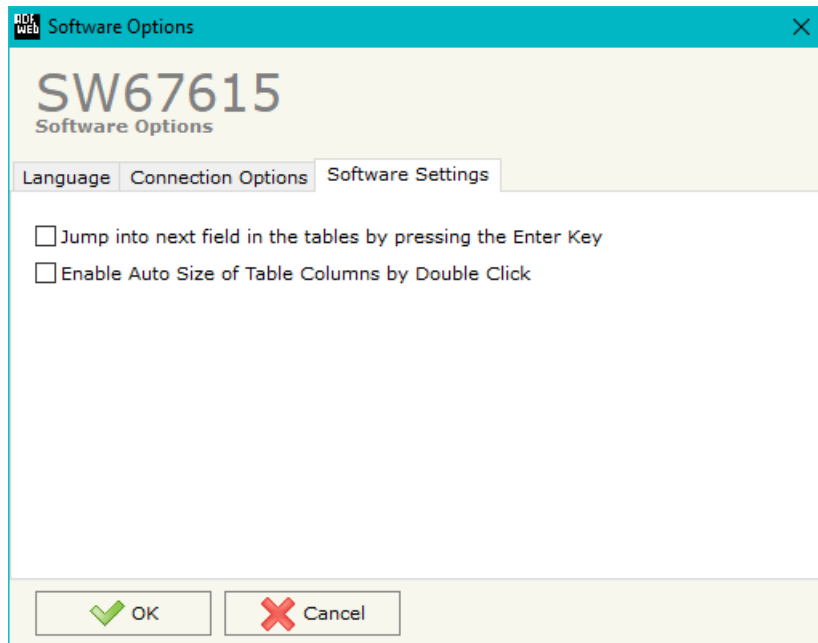

In the section "Software Settings", it is possible to enable/disable some keyboard's commands for an easier navigation inside the tables contained in the different sections of the software.

**SET COMMUNICATION:**

By Pressing the “**Set Communication**” button from the main window for SW67615 (Fig. 2) the window “Set Communication” appears (Fig. 3).

The window is divided in different sections in order to define the different parameters of the converter:

- PROFINET
- RS232
- RS485 / RS422
- RS485 2

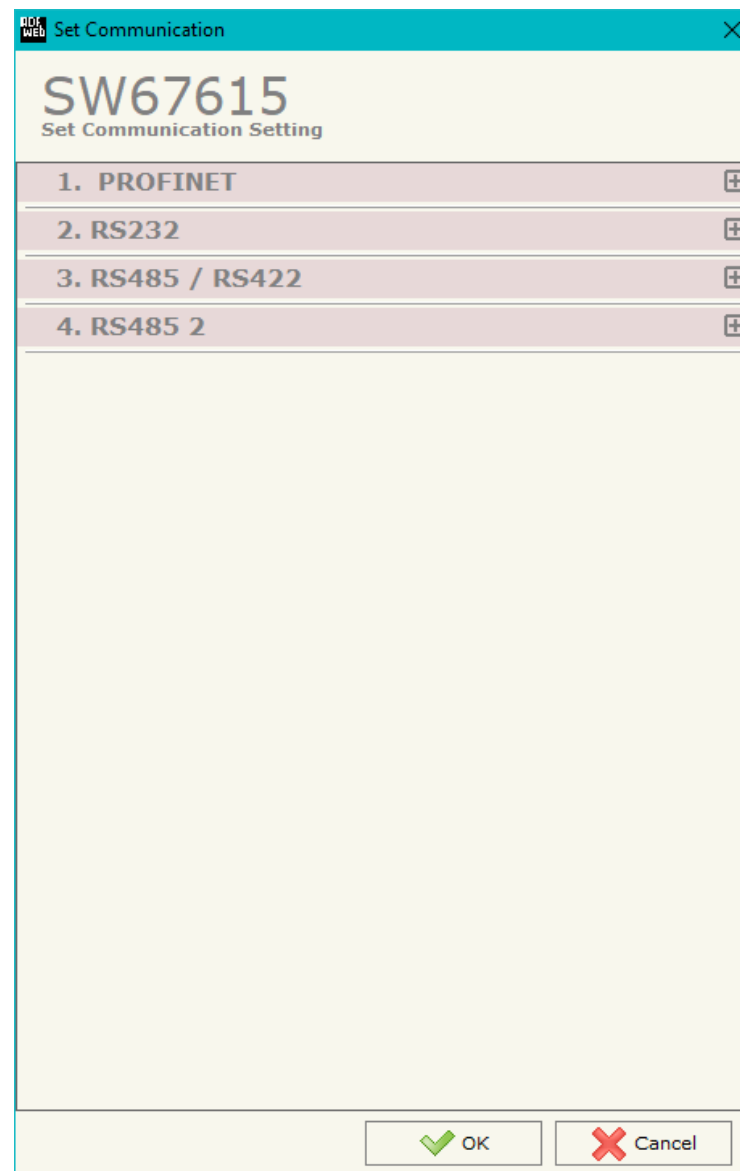
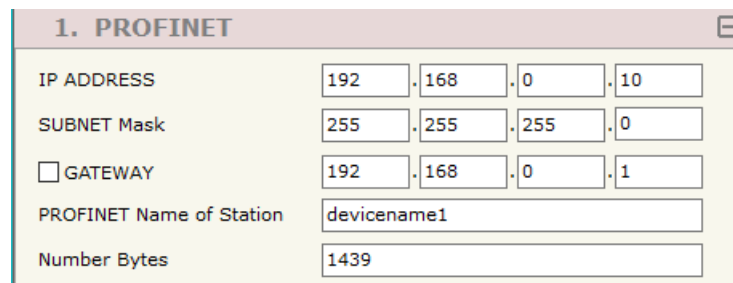

Figure 3a: “Set Communication” window

### **PROFINET:**

This section is used to define the parameters of PROFINET side of the converter. It is possible to define:

- In the field "**IP Address**" the IP address of the converter is defined;
- In the field "**SubNet Mask**" the SubNet Mask of the converter is defined;
- In the field "**Gateway**" the default gateway of the net is defined. This feature can be enabled or disabled pressing the Check Box field. This feature is used for going out of the net;
- In the field "**PROFINET Name of Station**" the name for PROFINET side of the converter is defined.
- In the field "**Num Bytes**" the number output bytes of the converter is defined.



<b>1. PROFINET</b>				
IP ADDRESS	192	.168	.0	.10
SUBNET Mask	255	.255	.255	.0
<input type="checkbox"/> GATEWAY	192	.168	.0	.1
PROFINET Name of Station	devicename1			
Number Bytes	1439			

Figure 3b: "Set Communication → PROFINET" window

### **RS232:**

This section is used to define the main parameters of RS232 line. The means of the fields are:

- If the field "**Enable RS232**" is checked, the serial port is enabled;
- In the field "**Baudrate**" the baudrate for the serial line is defined;
- In the field "**Parity**" the parity of the serial line is defined;
- In the field "**Stop Bits**" the number of stop bits of the serial line is defined.

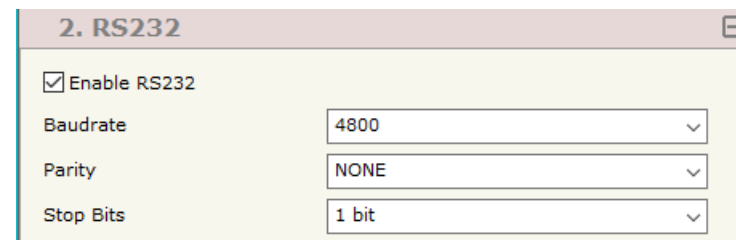

<b>2. RS232</b>	
<input checked="" type="checkbox"/> Enable RS232	
Baudrate	4800
Parity	NONE
Stop Bits	1 bit

Figure 3c: "Set Communication → RS232" window

### **RS485 / RS422:**

This section is used to define the main parameters of RS485 / RS422 line. The means of the fields are:

- If the field "**Enable RS485 / RS422**" is checked, the serial port is enabled;
- In the field "**Baudrate**" the baudrate for the serial line is defined;
- In the field "**Parity**" the parity of the serial line is defined;
- In the field "**Stop Bits**" the number of stop bits of the serial line is defined.

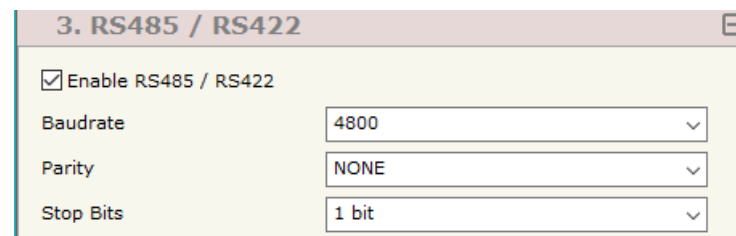

<b>3. RS485 / RS422</b>	
<input checked="" type="checkbox"/> Enable RS485 / RS422	
Baudrate	4800
Parity	NONE
Stop Bits	1 bit

Figure 3d: "Set Communication → RS485 / RS422" window

**RS485 2:**

This section is used to define the main parameters of RS485 2 line. The means of the fields are:

- If the field "**Enable RS485 2**" is checked, the serial port is enabled;
- In the field "**Baudrate**" the baudrate for the serial line is defined;
- In the field "**Parity**" the parity of the serial line is defined;
- In the field "**Stop Bits**" the number of stop bits of the serial line is defined.

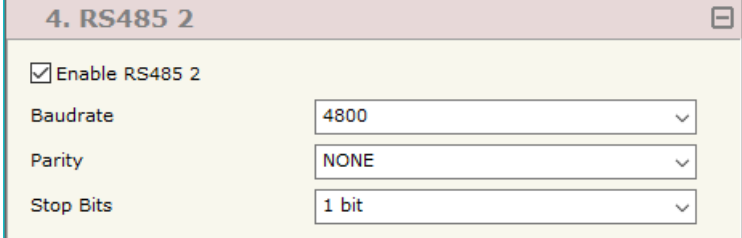

The screenshot shows a configuration window titled "4. RS485 2". It contains the following settings:

<input checked="" type="checkbox"/> Enable RS485 2	
Baudrate	4800
Parity	NONE
Stop Bits	1 bit

Figure 3e: "Set Communication → RS485 2" window

**RECEIVE FRAMES:**

By pressing the “**NMEA 0183 Access**” button from the main window for SW67615 (Fig. 2) the “Definition of NMEA 0183 Sentences” window appears (Fig. 4).

The NMEA 0183 sentences inserted in this table contain the output data of PROFINET. These sentences are accepted by the converter.

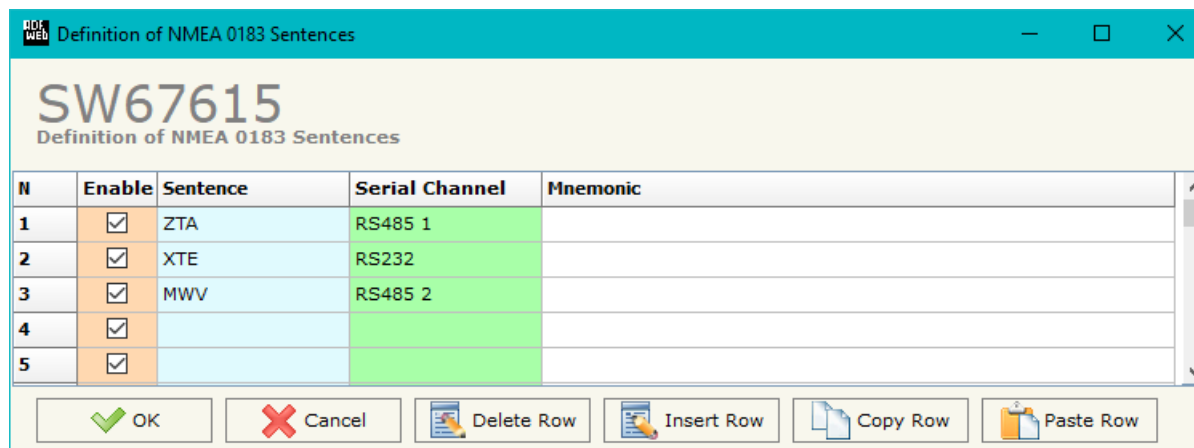

Figure 4: “Definition of NMEA 0183 Sentences” window

The data of the columns have the following meanings:

- If the field “**Enable**” is checked, the NMEA 0183 sentence is enabled;
- In the field “**Sentence**” the NMEA 0183 sentence is defined;
- In the field “**Serial Channel**” the serial port from which the sentence will be received is defined;
- In the field “**Mnemonic**” a brief description is defined.

**PROFINET XML:**

By Pressing the “**PROFINET XML**” button from the main window for SW67615 (Fig. 2) it is possible to generate the xml file to be imported into the master PROFINET.

Figure 5: “PROFINET XML File Name” window

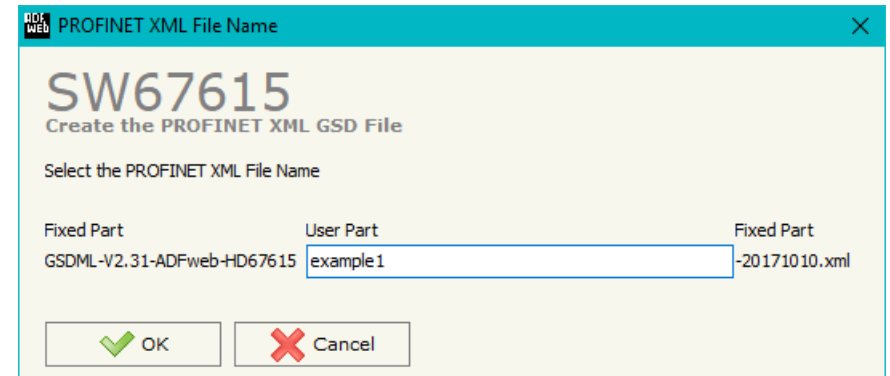

**OBJECTS MAP:**

By Pressing the “**Objects Map**” button from the main window for SW67615 (Fig. 2) it is possible to generate the a map file where the map of PROFINET side of the conveter is described.

### UPDATE DEVICE:

By pressing the **Update Device** button, it is possible to load the created Configuration into the device; and also the Firmware, if necessary.

If you don't know the actual IP address of the device you have to use this procedure:

- Turn OFF the Device;
- Put Dip2 of 'Dip-Switch A' in ON position;
- Turn ON the device
- Connect the Ethernet cable;
- Insert the IP **"192.168.2.205"**;
- Select which operations you want to do;
- Press the **"Execute update firmware"** button to start the upload;
- When all the operations are "OK" turn OFF the Device;
- Put Dip2 of 'Dip-Switch A' in OFF position;
- Turn ON the device.

If you know the actual IP address of the device, you have to use this procedure:

- Turn ON the Device with the Ethernet cable inserted;
- Insert the actual IP of the Converter;
- Select which operations you want to do;
- Press the **"Execute update firmware"** button to start the upload;
- When all the operations are "OK" the device automatically goes at Normal Mode.

At this point the configuration/firmware on the device is correctly updated.

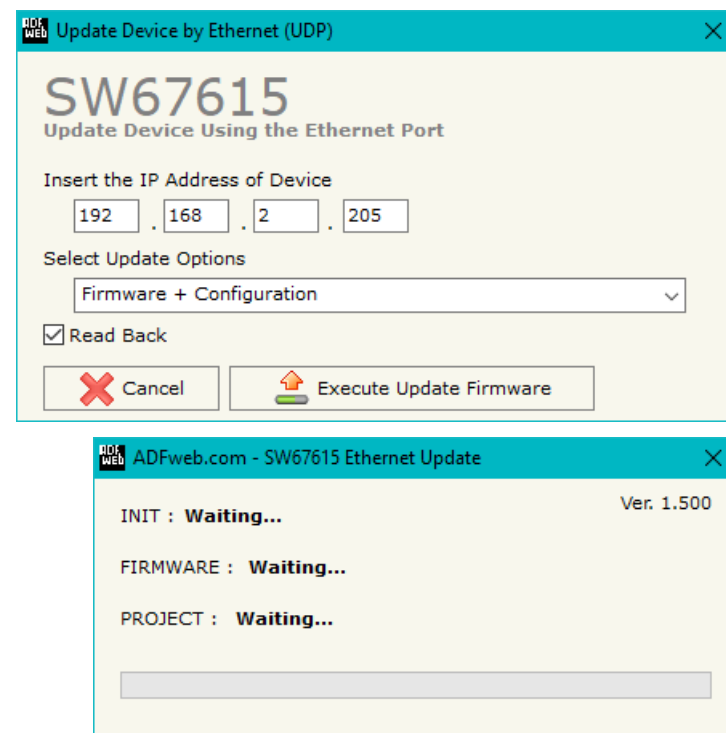

Figure 6: "Update Device" windows



**Note:**

When you install a new version of the software, if it is the first time it is better you do the update of the Firmware in the HD67615 device.

**Note:**

When you receive the device, for the first time, you also have to update the Firmware in the HD67615 device.

**Warning:**

If Fig. 7 appears when you try to do the Update try these points before seeking assistance:

- Try to repeat the operations for the updating;
- Try with another PC;
- Try to restart the PC;
- Check the LAN settings;
- If you are using the program inside a Virtual Machine, try to use in the main Operating System;
- If you are using Windows Seven, Vista, 8 and 10 make sure that you have the administrator privileges;
- In case you have to program more than one device, using the "UDP Update", you have to cancel the ARP table every time you connect a new device on Ethernet. For do this you have to launch the "Command Prompt" and write the command "arp -d". Pay attention that with Windows Vista, Seven, 8 you have to launch the "Command Prompt" with Administrator Rights;
- Pay attention at Firewall lock.

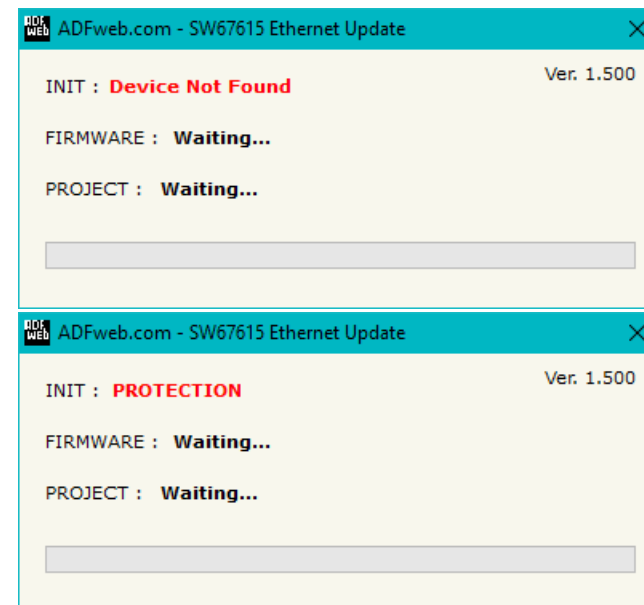
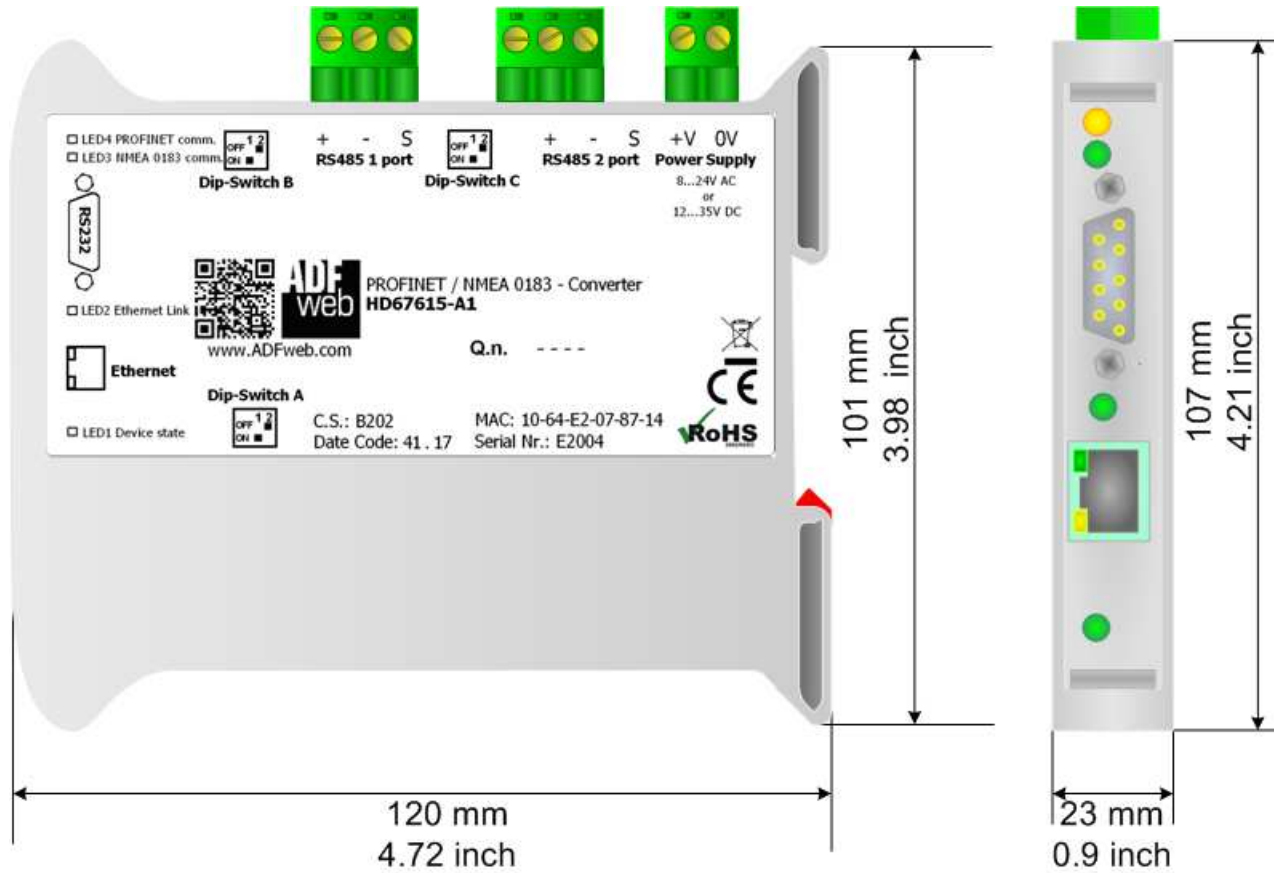

Figure 7: "Error" windows

In the case of HD67615 you have to use the software "SW67615": [www.adfweb.com/download/filefold/SW67615.zip](http://www.adfweb.com/download/filefold/SW67615.zip).

**MECHANICAL DIMENSIONS:**



Housing: PVC  
Weight: 200g (Approx)

Figure 8: Mechanical dimensions scheme for HD67615-xxx-A1

**ORDERING INFORMATIONS:**

The ordering part number is formed by a valid combination of the following:

**HD67615 - xxx - A 1**

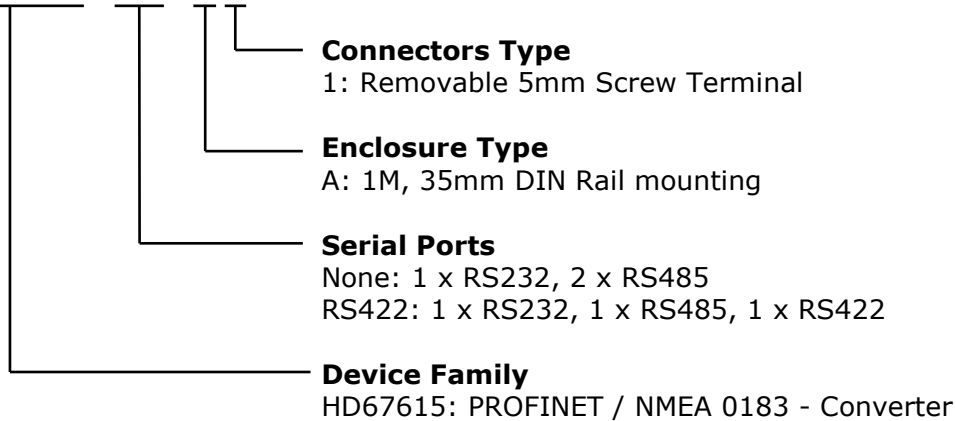

- Order Code: **HD67615-A1** - PROFINET / NMEA 0183 – Converter (1 x RS232, 2 x RS485)
- Order Code: **HD67615-422-A1** - PROFINET / NMEA 0183 – Converter (1 x RS232, 1 x RS485, 1 x RS422)

**ACCESSORIES:**

- Order Code: **AC34107** - Null Modem Cable Fem/Fem DSub 9 Pin 1,5 m
- Order Code: **AC34114** - Null Modem Cable Fem/Fem DSub 9 Pin 5 m
- Order Code: **AC34011** - Rail DIN - Power Supply 220/240V AC 50/60Hz – 12 V DC
- Order Code: **AC34012** - Rail DIN - Power Supply 220/240V AC 50/60Hz – 24 V DC

**DISCLAIMER:**

All technical content within this document can be modified without notice. The content of the document is a under continual renewal. For losses due to fire, earthquake, third party access or other accidents, or intentional or accidental abuse, misuse, or use under abnormal conditions repairs are charged to the user. ADFweb.com S.r.l. will not be liable for accidental loss of use or inability to use this product, such as loss of business income. ADFweb.com S.r.l. shall not be liable for consequences of improper use.

**OTHER REGULATIONS AND STANDARDS:****WEEE INFORMATION**

Disposal of old electrical and electronic equipment (as in the European Union and other European countries with separate collection systems).

— This symbol on the product or on its packaging indicates that this product may not be treated as household rubbish. Instead, it should be taken to an applicable collection point for the recycling of electrical and electronic equipment. If the product is disposed correctly, you will help prevent potential negative environmental factors and impact of human health, which could otherwise be caused by inappropriate disposal. The recycling of materials will help to conserve natural resources. For more information about recycling this product, please contact your local city office, your household waste disposal service or the shop where you purchased the product.

**RESTRICTION OF HAZARDOUS SUBSTANCES DIRECTIVE**

The device respects the 2002/95/EC Directive on the restriction of the use of certain hazardous substances in electrical and electronic equipment (commonly referred to as Restriction of Hazardous Substances Directive or RoHS).

**CE MARKING**

The product conforms with the essential requirements of the applicable EC directives.

**WARRANTIES AND TECHNICAL SUPPORT:**

For fast and easy technical support for your ADFweb.com SRL products, consult our internet support at [www.adfweb.com](http://www.adfweb.com). Otherwise contact us at the address [support@adfweb.com](mailto:support@adfweb.com)

**RETURN POLICY:**

If while using your product you have any problem and you wish to exchange or repair it, please do the following:

- Obtain a Product Return Number (PRN) from our internet support at [www.adfweb.com](http://www.adfweb.com). Together with the request, you need to provide detailed information about the problem.
- Send the product to the address provided with the PRN, having prepaid the shipping costs (shipment costs billed to us will not be accepted).

If the product is within the warranty of twelve months, it will be repaired or exchanged and returned within three weeks. If the product is no longer under warranty, you will receive a repair estimate.



**ADFweb.com S.r.l.**  
Via Strada Nuova, 17  
IT-31010 Mareno di Piave  
TREVISO (Italy)  
Phone +39.0438.30.91.31  
Fax +39.0438.49.20.99  
[www.adfweb.com](http://www.adfweb.com)

