

User Manual

Revision 1.000
English

EtherNet/IP Master / DeviceNet Slave - Converter

(Order Code: HD67647-A1)

For Website information:

www.adfweb.com?Product=HD67647

For Price information:

www.adfweb.com?Price=HD67647-A1

Benefits and Main Features:

- ✦ Very easy to configure
- ✦ Triple Electrical isolation
- ✦ Temperature range: -40°C/+85°C (-40°F/+185°F)

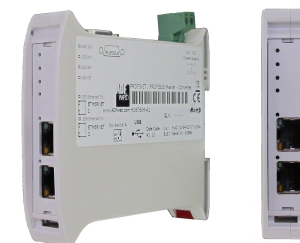

User Manual

For other EtherNet/IP Master Slave products see also the following link:

Converter EtherNet/IP Master to

www.adfweb.com?Product=HD67B38
www.adfweb.com?Product=HD67D24
www.adfweb.com?Product=HD67E26
www.adfweb.com?Product=HD67158
www.adfweb.com?Product=HD67643
www.adfweb.com?Product=HD67645
www.adfweb.com?Product=HD67646
www.adfweb.com?Product=HD67647
www.adfweb.com?Product=HD67661
www.adfweb.com?Product=HD67665
www.adfweb.com?Product=HD67667
www.adfweb.com?Product=HD67668
www.adfweb.com?Product=HD67669
www.adfweb.com?Product=HD67689
www.adfweb.com?Product=HD67743
www.adfweb.com?Product=HD67806
www.adfweb.com?Product=HD67955
www.adfweb.com?Product=HD67973

(OPC UA Server)
(LoRaWAN)
(EtherCAT)
(SNMP Agent)
(PROFIBUS Slave)
(CAN)
(CANopen)
(DeviceNet Slave)
(PROFINET)
(Modbus TCP Slave)
(Serial)
(Ethernet)
(Modbus Slave)
(BACnet Slave)
(IEC 61850 Server)
(KNX)
(MQTT)
(IO-Link Slave)

INDEX:

	Page
INDEX	2
UPDATED DOCUMENTATION	2
REVISION LIST	2
WARNING	2
TRADEMARKS	2
SECURITY ALERT	3
EXAMPLE OF CONNECTION	4
CONNECTION SCHEME	5
CHARACTERISTICS	6
CONFIGURATION	6
POWER SUPPLY	7
FUNCTION MODES	8
LEDS	9
CAN	10
ETHERNET	11
USE OF COMPOSITOR SW67647	12
NEW CONFIGURATION / OPEN CONFIGURATION	13
SOFTWARE OPTIONS	14
SET COMMUNICATION	16
ETHERNET/IP SET ACCESS	17
UPDATE DEVICE	18
MECHANICAL DIMENSIONS	20
ORDERING INFORMATIONS	21
ACCESSORIES	21
DISCLAIMER	22
OTHERS REGULATIONS AND STANDARDS	22
WARRANTIES AND TECHNICAL SUPPORT	23
RETURN POLICY	23

UPDATED DOCUMENTATION:

Dear customer, we thank you for your attention and we remind you that you need to check that the following document is:

- ✚ Updated
- ✚ Related to the product you own

To obtain the most recently updated document, note the “document code” that appears at the top right-hand corner of each page of this document.

With this “Document Code” go to web page www.adfweb.com/download/ and search for the corresponding code on the page. Click on the proper “Document Code” and download the updates.

REVISION LIST:

Revision	Date	Author	Chapter	Description
1.000	18/09/2020	Ff	All	First Release

WARNING:

ADFweb.com reserves the right to change information in this manual about our product without warning.

ADFweb.com is not responsible for any error this manual may contain.

TRADEMARKS:

All trademarks mentioned in this document belong to their respective owners.

SECURITY ALERT:**GENERAL INFORMATION**

To ensure safe operation, the device must be operated according to the instructions in the manual. When using the device, legal and safety regulation are required for each individual application. The same applies also when using accessories.

INTENDED USE

Machines and systems must be designed so the faulty conditions do not lead to a dangerous situation for the operator (i.e. independent limit switches, mechanical interlocks, etc.).

QUALIFIED PERSONNEL

The device can be used only by qualified personnel, strictly in accordance with the specifications. Qualified personnel are persons who are familiar with the installation, assembly, commissioning and operation of this equipment and who have appropriate qualifications for their job.

RESIDUAL RISKS

The device is state-of-the-art and is safe. The instruments can represent a potential hazard if they are inappropriately installed and operated by untrained personnel. These instructions refer to residual risks with the following symbol:



This symbol indicates that non-observance of the safety instructions is a danger for people that could lead to serious injury or death and / or the possibility of damage.

CE CONFORMITY

The declaration is made by our company. You can send an email to support@adfweb.com or give us a call if you need it.

EXAMPLE OF CONNECTION:

EtherNet/IP / CAN - Converter
HD67645-A1

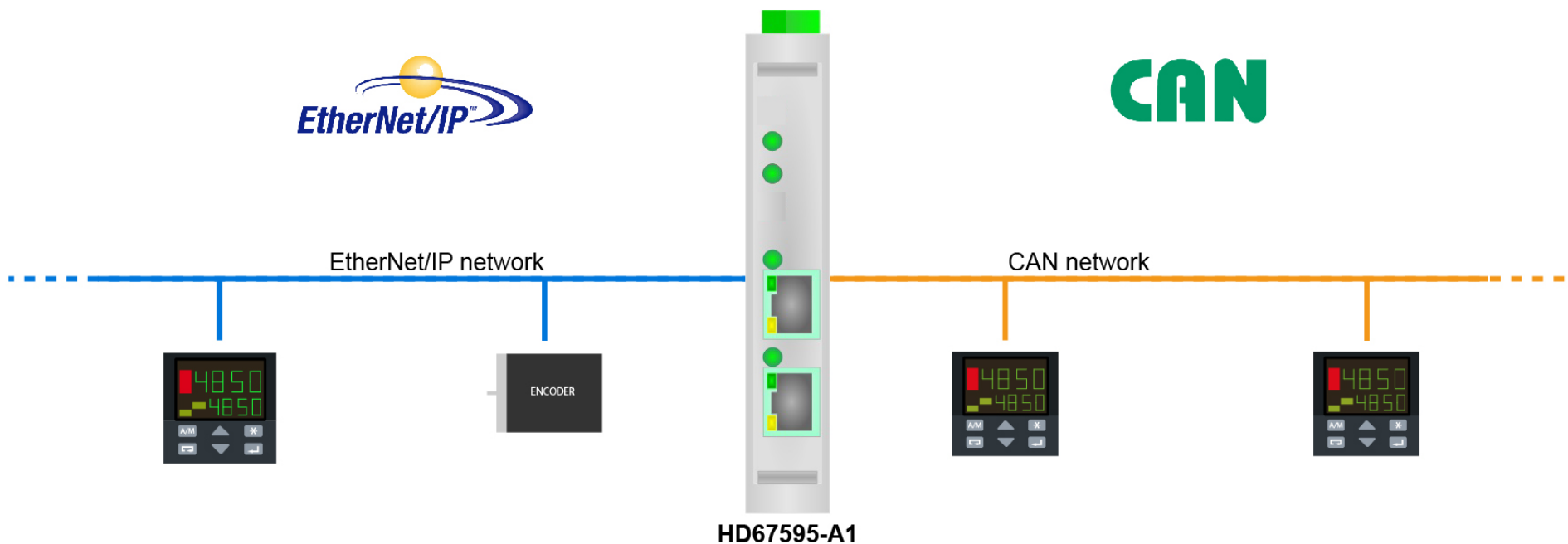

ADFweb.com



+39 0438 309 131



+39 349 440 9592



support@adfweb.com

CONNECTION SCHEME:

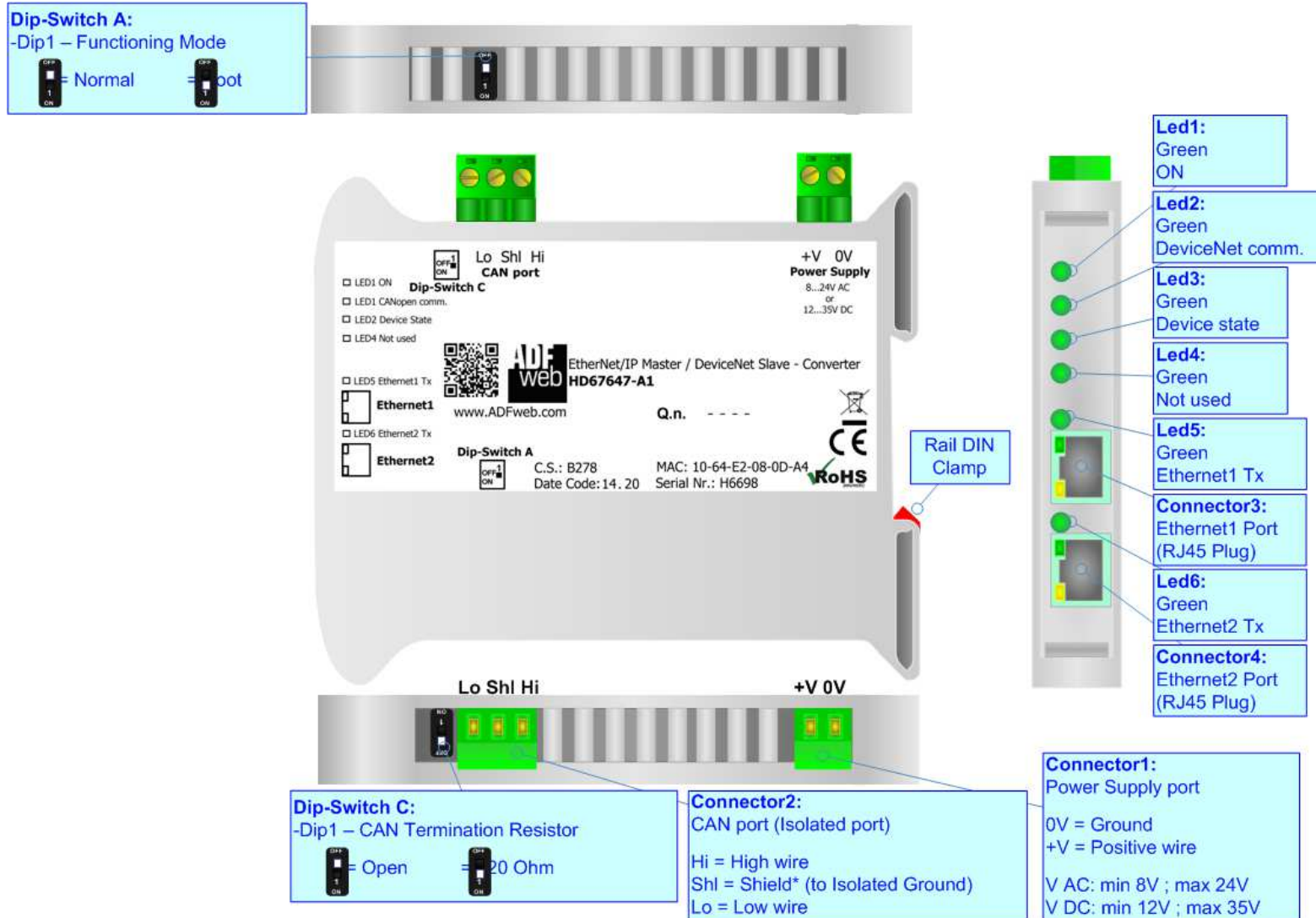

Figure 1: Connection scheme for HD67647-A1

CHARACTERISTICS:

The HD67647-A1 are EtherNet/IP / DeviceNet - Converters.

It allows for the following characteristics:

- Isolation between EtherNet/IP – DeviceNet – Power Supply;
- Two-directional information between EtherNet/IP bus and DeviceNet bus;
- Mountable on 35mm Rail DIN;
- Wide power supply input range: 8...24V AC or 12...35V DC;
- Wide temperature range: -40°C / 85°C [-40°F / +185°F].

CONFIGURATION:

You need Compositor SW67647 software on your PC in order to perform the following:

- Define the parameters of EtherNet/IP line;
- Define the parameters of DeviceNet line;
- Define the list of EtherNet/IP slaves connected to the converter;
- Update the device.

POWER SUPPLY:

The devices can be powered at 8...24V AC and 12...35V DC. For more details see the two tables below.

VAC		VDC	
Vmin	Vmax	Vmin	Vmax
8V	24V	12V	35V

Consumption at 24V DC:

Device	Consumption [W/VA]
HD67647-A1	3.5

Caution: Do not reverse the polarity power

Dip-Switch A:
 -Dip1 – Must be at ON
 -Dip2 – Functioning Mode

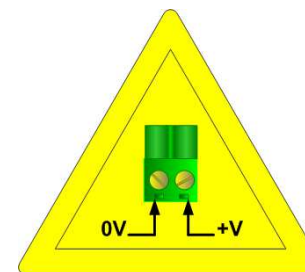

HD67647-A1

FUNCTION MODES:

The device has got two function modes depending on the position of the 'Dip1 of Dip-Switch A':

- The first, with 'Dip1 of Dip-Switch A' at "OFF" position, is used for the normal working of the device.
- The second, with 'Dip1 of Dip-Switch A' at "ON" position, is used for uploading the Project and/or Firmware.

For the operations to follow for the updating, see 'UPDATE DEVICE' section.

According to the functioning mode, the LEDs will have specific functions, see 'LEDS' section.

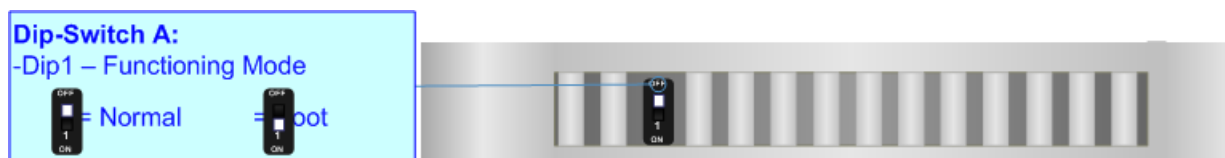

LEDS:

The device has got seven LEDs that are used to give information about the functioning status.
The various meanings of the LEDs are described in the table below.

LED	Normal Mode	Boot Mode
1: ON (green)	ON: Device powered OFF: Device not powered	ON: Device powered OFF: Device not powered
2: CAN comm. (green)	It blinks when a CAN message is received	Blinks quickly: Boot state Blinks very slowly (~0.5Hz): update in progress
3: Device State (green)	Blinks slowly (~1Hz)	Blinks quickly: Boot state Blinks very slowly (~0.5Hz): update in progress
4: Ethernet comm. (green)	It blinks when EtherNet/IP communication is running	Blinks quickly: Boot state Blinks very slowly (~0.5Hz): update in progress
5: Ethernet1 link (green)	ON: Ethernet cable connected OFF: Ethernet cable disconnected	ON: Ethernet cable connected OFF: Ethernet cable disconnected
6: Ethernet2 link (green)	ON: Ethernet cable connected OFF: Ethernet cable disconnected	ON: Ethernet cable connected OFF: Ethernet cable disconnected

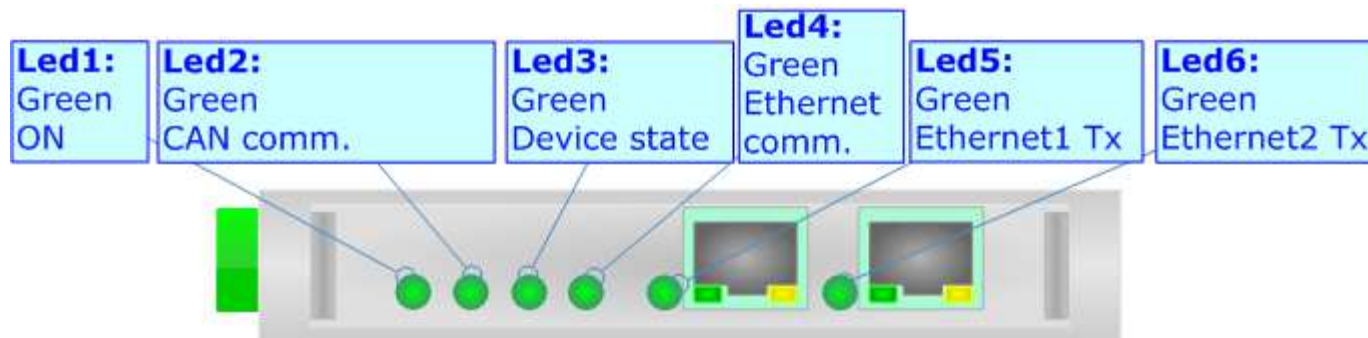

CAN:

For terminating the CAN line with a 120Ω resistor it is necessary that the Dip1 of 'Dip-Switch C' is at ON position.

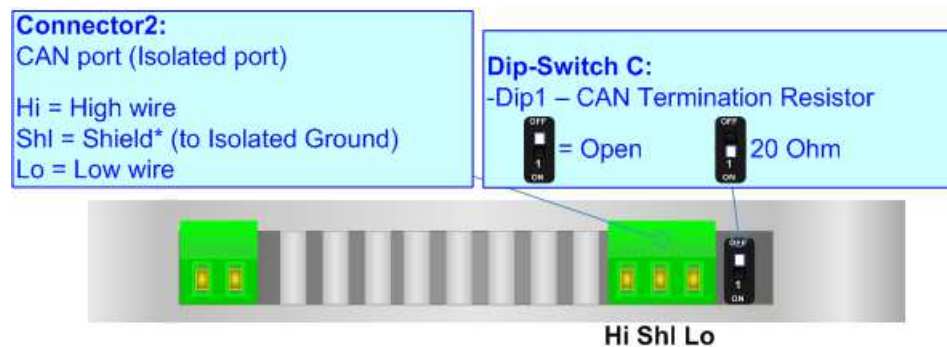

Cable characteristics:

DC parameter:	Impedance	70 Ohm/m
AC parameters:	Impedance	120 Ohm/m
	Delay	5 ns/m
Length	Baud Rate [bps]	Length MAX [m]
	10 K	5000
	20 K	2500
	50 K	1000
	100 K	650
	125 K	500
	250 K	250
	500 K	100
	800 K	50
	1000 K	25

ETHERNET:

The updating of the converter must be made using Connector3 and Connector4 of the HD67647-A1 with at least a Category 5E cable. The maximum length of the cable should not exceed 100m. The cable has to conform to the T568 norms relative to connections in cat.5 up to 100 Mbps. To connect the device to an Hub/Switch is recommended the use of a straight cable, to connect the device to a PC/PLC/other is recommended the use of a cross cable.

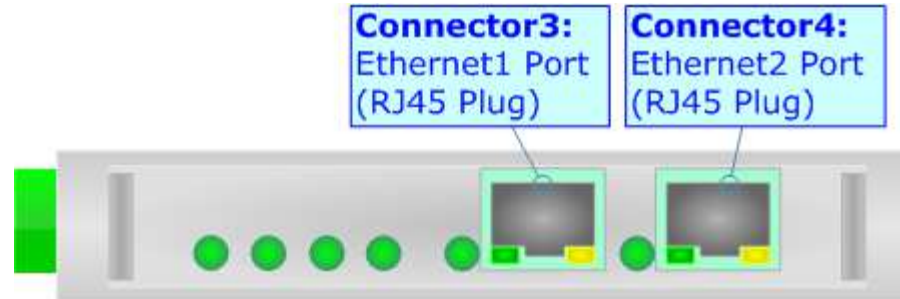

USE OF COMPOSITOR SW67647:

To configure the Converter, use the available software that runs with Windows called SW67647. It is downloadable on the site www.adfweb.com and its operation is described in this document. (*This manual is referenced to the last version of the software present on our web site*). The software works with MSWindows (XP, Vista, Seven, 8, 10; 32/64bit).

When launching the SW67647, the window below appears (Fig. 2).

**Note:**

It is necessary to have installed .Net Framework 4.



Figure 2: Main window for SW67647

NEW CONFIGURATION / OPEN CONFIGURATION:

The “**New Configuration**” button creates the folder which contains the entire device’s configuration.

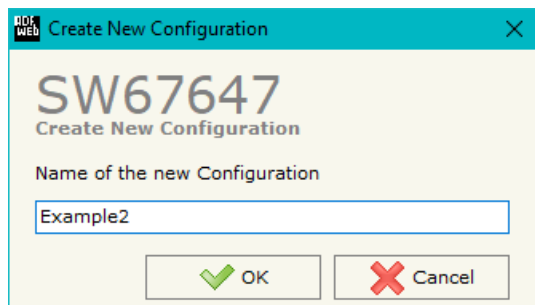

A device’s configuration can also be imported or exported:

- To clone the configurations of a programmable “EtherNet/IP Master / DeviceNet Slave - Converter” in order to configure another device in the same manner, it is necessary to maintain the folder and all its contents;
- To clone a project in order to obtain a different version of the project, it is sufficient to duplicate the project folder with another name and open the new folder with the button “**Open Configuration**”.

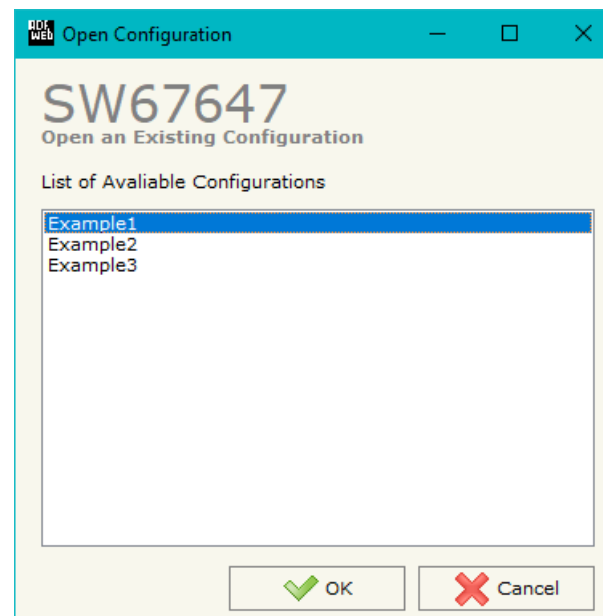

SOFTWARE OPTIONS:

By pressing the “**Settings**” () button there is the possibility to change the language of the software and check the updatings for the compositor.

In the section “Language” it is possible to change the language of the software.

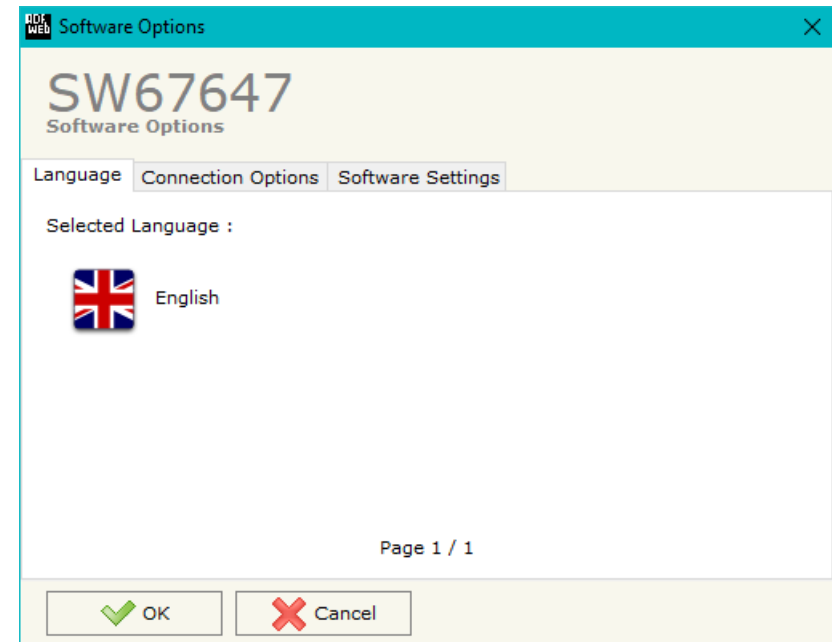
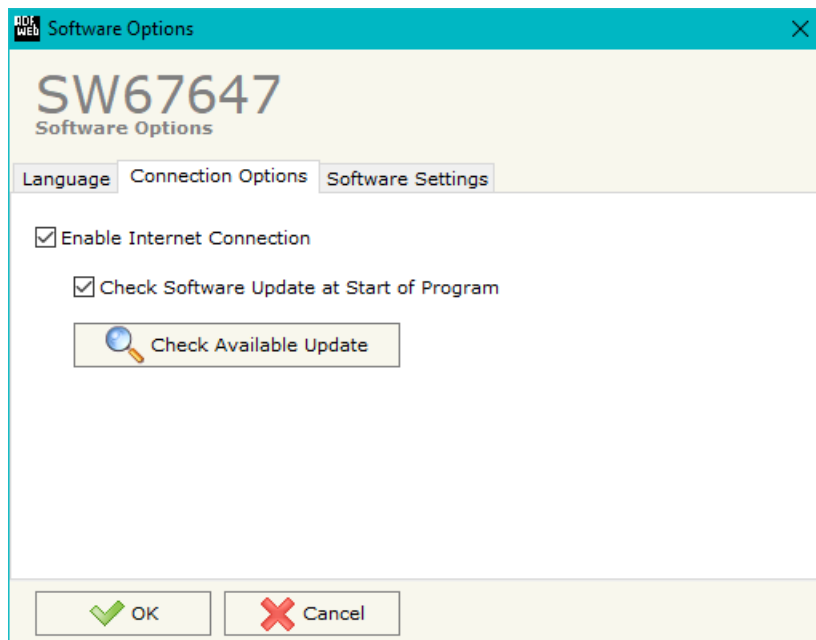

In the section “Connection Options”, it is possible to check if there are some updatings of the software compositor in ADFweb.com website. Checking the option “**Check Software Update at Start of Program**”, the SW67647 checks automatically if there are updatings when it is launched.

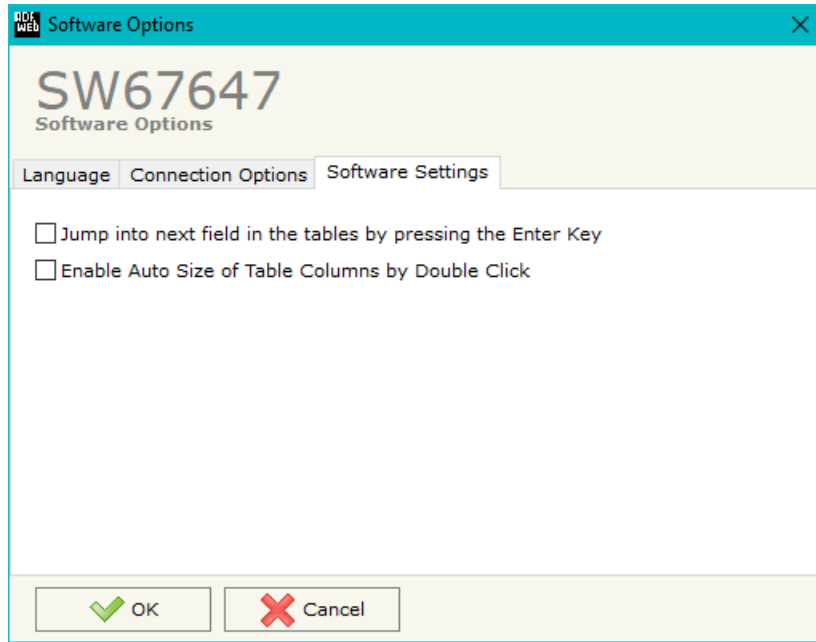

In the section "Software Settings", it is possible to enable/disable some keyboard's commands for an easier navigation inside the tables contained in the different sections of the software.

SET COMMUNICATION:

This section define the fundamental communication parameters of two buses, EtherNet/IP and DeviceNet.

By Pressing the **“Set Communication”** button from the main window for SW67647 (Fig. 2) the window **“Set Communication”** appears (Fig. 3).

The means of the fields for the **“DeviceNet Slave”** section are:

- In the field **“ID Device”** the address for the DeviceNet Master is defined;
- In the field **“Baudrate”** the velocity of the DeviceNet Slave bus is defined;
- In the field **“Number Byte IN”** the number input bytes of DeviceNet Master is defined (max 455 bytes);
- In the field **“Number Byte OUT”** the number output bytes of DeviceNet Master is defined (max 455 bytes).

The means of the fields for **“EtherNet/IP Master”** are:

- In the fields **“IP ADDRESS”** the IP address for EtherNet/IP side of the converter is defined;
- In the fields **“SUBNET Mask”** the SubNet Mask for EtherNet/IP side of the converter is defined;
- In the fields **“GATEWAY”** the default gateway of the net is defined. This feature can be enabled or disabled pressing the Check Box field. This feature is used for going out of the net;
- In the field **“Port”** the port used for EtherNet/IP communication is defined. The port has a fixed value of 44818.

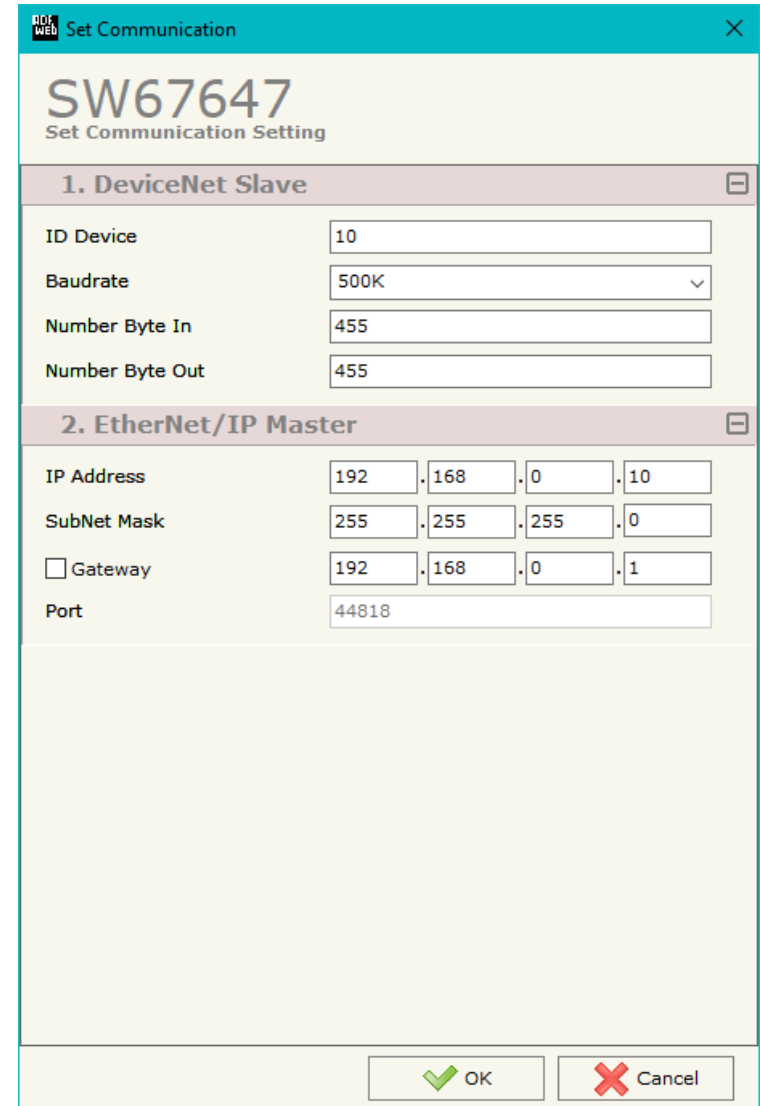

Figure 3: **“Set Communication”** window

ETHERNET/IP ACCESS:

By Pressing the “**EtherNet/IP Access**” button from the main window for SW67647 (Fig. 2) the window “Set EtherNet/IP Master Access” appears (Fig. 4).

This section is used to define the list of the EtherNet/IP Slaves to read/write with the DeviceNet Master.

N	Enable	IP Address	Start Input	Num Input	Start Output	Num Output	Time Poll	Instance T > O	Conn. Point T > O	Instance O > T	Conn. Point O > T	Dim Header T > O	Dim Header O > T	Mnemonic
1	<input checked="" type="checkbox"/>	192.168.0.12	0	10	5	15	1000	1	100	1	101	Default	Default	
2	<input checked="" type="checkbox"/>	192.168.2.13	1	5	0	0	2500	1	100	1	101	Default	Default	
3	<input checked="" type="checkbox"/>													
4	<input checked="" type="checkbox"/>													
5	<input checked="" type="checkbox"/>													

Figure 4: “Set EtherNet/IP Slaves Access” window

The means of the fields are:

- If the field “**Enable**” is checked, the polling to the EtherNet/IP Slave is enabled;
- In the field “**IP Address**” the IP Address of the EtherNet/IP Slave is defined;
- In the field “**Start Input**” the starting Input byte of the EtherNet/IP Slave to map on DeviceNet side is defined;
- In the field “**Num Input**” the number of consecutive Input byte to map on DeviceNet side is defined;
- In the field “**Start Output**” the starting Output byte of the EtherNet/IP Slave to write from DeviceNet side is defined;
- In the field “**Num Output**” the number of consecutive Output byte to write from DeviceNet side is defined;
- In the field “**Time Poll**” the polling time in ms is defined;
- In the field “**Instance T > O**” the instance of the assembly for the Target to Originator data direction is defined;
- In the field “**Conn. Point T > O**” the connection point of the assembly for the Target to Originator data direction is defined;
- In the field “**Instance O > T**” the instance of the assembly for the Originator to Target data direction is defined;
- In the field “**Conn. Point O > T**” the connection point of the assembly for the Originator to Target data direction is defined;
- In the field “**Dim Header T > O**” the dimension of the header for the Target to Originator data direction is defined;
- In the field “**Dim Header O > T**” the dimension of the header for the Originator to Target data direction is defined;
- In the field “**Mnemonic**” a brief description is defined.

UPDATE DEVICE:

By pressing the **“Update Device”** button, it is possible to load the created Configuration into the device; and also the Firmware, if necessary. This by using the Ethernet port.

If you don't know the actual IP address of the device you have to use this procedure:

- Turn OFF the Device;
- Put Dip1 of 'Dip-Switch A' in ON position;
- Turn ON the device
- Connect the Ethernet cable;
- Insert the IP **“192.168.2.205”**;
- Select which operations you want to do;
- Press the **“Execute update firmware”** button to start the upload;
- When all the operations are “OK” turn OFF the Device;
- Put Dip1 of 'Dip-Switch A' in OFF position;
- Turn ON the device.

If you know the actual IP address of the device, you have to use this procedure:

- Turn ON the Device with the Ethernet cable inserted;
- Insert the actual IP of the Converter;
- Select which operations you want to do;
- Press the **“Execute update firmware”** button to start the upload;
- When all the operations are “OK” the device automatically goes at Normal Mode.

At this point the configuration/firmware on the device is correctly updated.

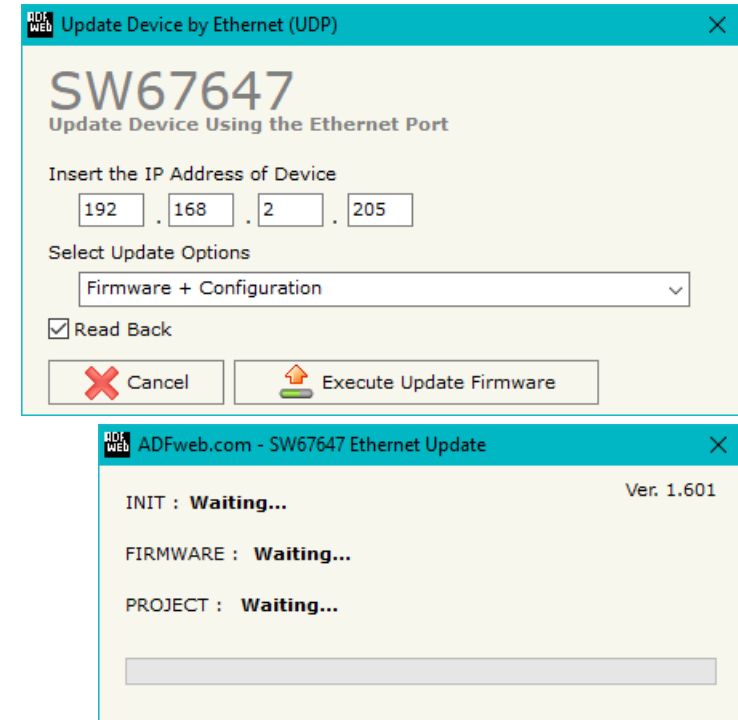

Figure 5: “Update device” windows

**Note:**

When you receive the device, for the first time, you also have to update the Firmware in the HD67647 device.

**Warning:**

If Fig. 6 appears when you try to do the Update try these points before seeking assistance:

- Try to repeat the operations for the updating;
- Try with another PC;
- Try to restart the PC;
- Check the LAN settings;
- If you are using the program inside a Virtual Machine, try to use in the main Operating System;
- If you are using Windows Seven, Vista, 8 or 10 make sure that you have the administrator privileges;
- In case you have to program more than one device, using the "UDP Update", you have to cancel the ARP table every time you connect a new device on Ethernet. For do this you have to launch the "Command Prompt" and write the command "arp -d". Pay attention that with Windows Vista, Seven, 8, 10 you have to launch the "Command Prompt" with Administrator Rights;
- Pay attention at Firewall lock.

**Warning:**

In the case of HD67647 you have to use the software "HD67647": www.adfweb.com/download/filefold/SW67647.zip.

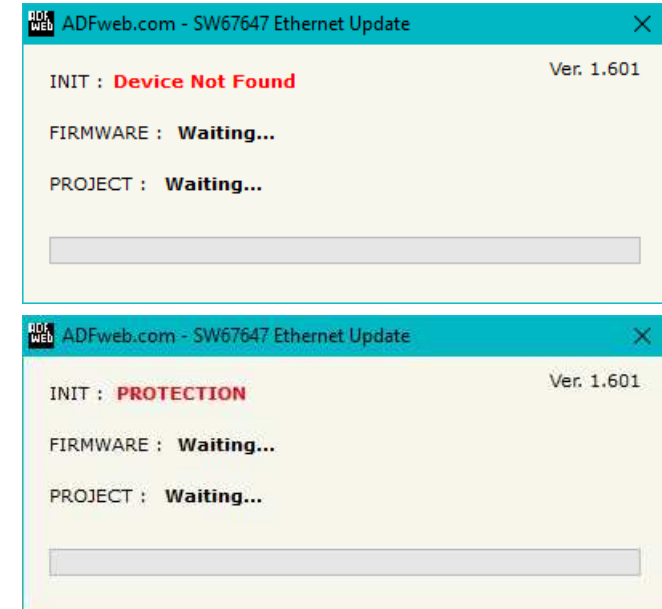

Figure 6: "Error" window

MECHANICAL DIMENSIONS:

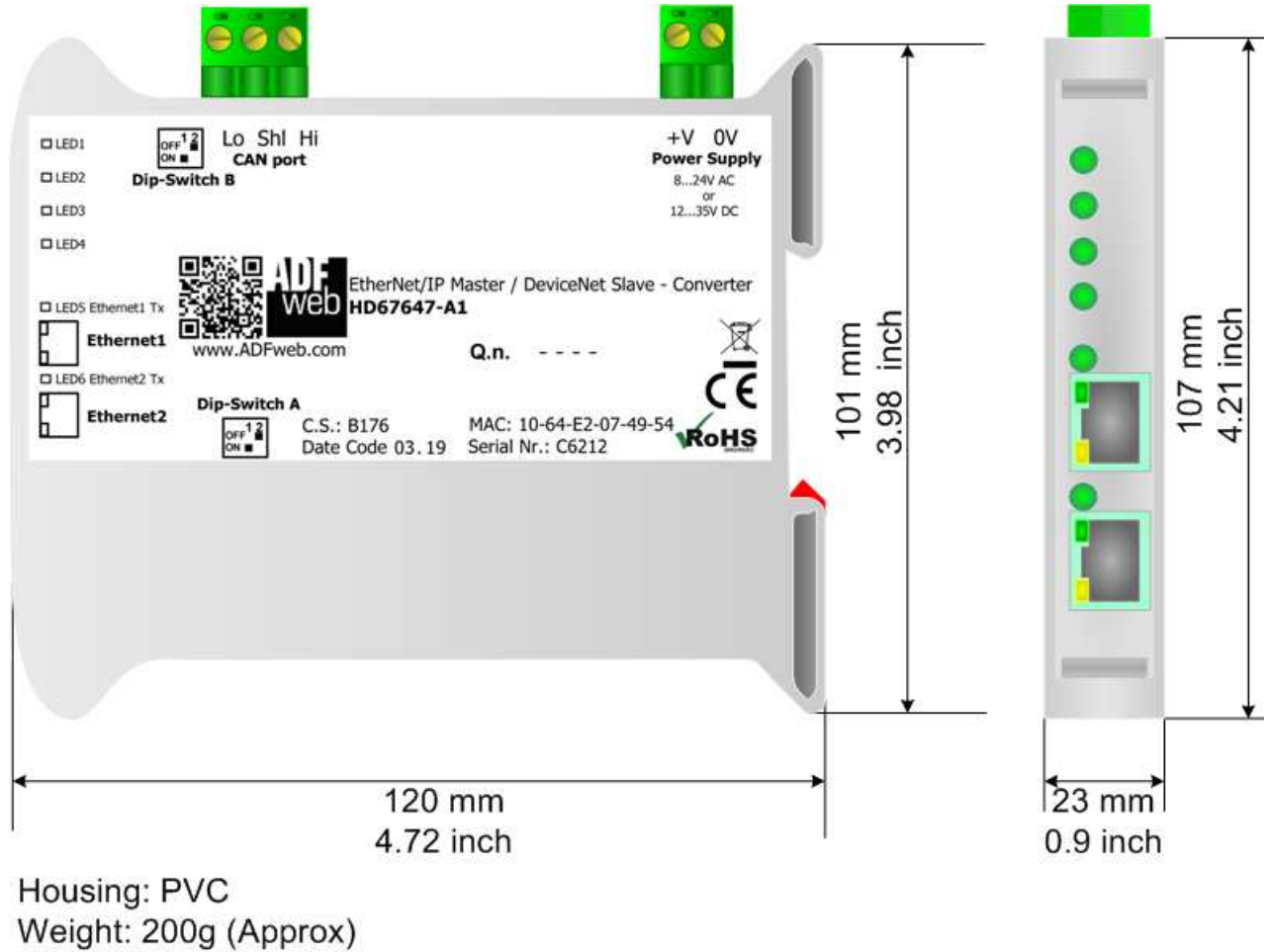
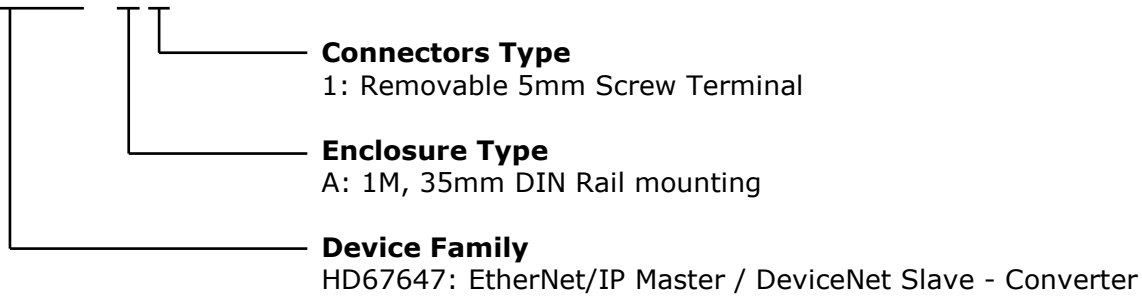

Figure 7: Mechanical dimensions scheme for HD67647-A1

ORDERING INFORMATIONS:

The ordering part number is formed by a valid combination of the following:

HD67647 - xx



Order Code: **HD67647-A1** - EtherNet/IP Master / DeviceNet Slave – Converter

ACCESSORIES:

Order Code: **AC34011** - 35mm Rail DIN - Power Supply 220/240V AC 50/60Hz – 12 V DC

Order Code: **AC34012** - 35mm Rail DIN - Power Supply 220/240V AC 50/60Hz – 24 V DC

DISCLAIMER:

All technical content within this document can be modified without notice. The content of the document is a under continual renewal. For losses due to fire, earthquake, third party access or other accidents, or intentional or accidental abuse, misuse, or use under abnormal conditions repairs are charged to the user. ADFweb.com S.r.l. will not be liable for accidental loss of use or inability to use this product, such as loss of business income. ADFweb.com S.r.l. shall not be liable for consequences of improper use.

OTHER REGULATIONS AND STANDARDS:**WEEE INFORMATION**

Disposal of old electrical and electronic equipment (as in the European Union and other European countries with separate collection systems).

— This symbol on the product or on its packaging indicates that this product may not be treated as household rubbish. Instead, it should be taken to an applicable collection point for the recycling of electrical and electronic equipment. If the product is disposed correctly, you will help prevent potential negative environmental factors and impact of human health, which could otherwise be caused by inappropriate disposal. The recycling of materials will help to conserve natural resources. For more information about recycling this product, please contact your local city office, your household waste disposal service or the shop where you purchased the product.

RESTRICTION OF HAZARDOUS SUBSTANCES DIRECTIVE

The device respects the 2002/95/EC Directive on the restriction of the use of certain hazardous substances in electrical and electronic equipment (commonly referred to as Restriction of Hazardous Substances Directive or RoHS).

CE MARKING

The product conforms with the essential requirements of the applicable EC directives.

WARRANTIES AND TECHNICAL SUPPORT:

For fast and easy technical support for your ADFweb.com SRL products, consult our internet support at www.adfweb.com.
Otherwise contact us at the address support@adfweb.com

RETURN POLICY:

If while using your product you have any problem and you wish to exchange or repair it, please do the following:

- Obtain a Product Return Number (PRN) from our internet support at www.adfweb.com. Together with the request, you need to provide detailed information about the problem.
- Send the product to the address provided with the PRN, having prepaid the shipping costs (shipment costs billed to us will not be accepted).

If the product is within the warranty of twelve months, it will be repaired or exchanged and returned within three weeks. If the product is no longer under warranty, you will receive a repair estimate.



ADFweb.com S.r.l.
Via Strada Nuova, 17
IT-31010 Mareno di Piave
TREVISO (Italy)
Phone +39.0438.30.91.31
Fax +39.0438.49.20.99
www.adfweb.com

