

User Manual

Revision 1.100
English

Modbus TCP Slave / KNX - Converter

(Order Code: HD67815-KNX-B2)

for Website information:

www.adfweb.com?Product=HD67815

for Price information:

www.adfweb.com?Price=HD67815-KNX-B2

Benefits and Main Features:

- ⊕ Very easy to configure
- ⊕ Electrical isolation
- ⊕ Temperature range: -40°C/85°C (-40°F/185°F)



For others KNX products, see also the following links:

Converter KNX to

- www.adfweb.com?Product=HD67801
- www.adfweb.com?Product=HD67802
- www.adfweb.com?Product=HD67803
- www.adfweb.com?Product=HD67804
- www.adfweb.com?Product=HD67807
- www.adfweb.com?Product=HD67808
- www.adfweb.com?Product=HD67809
- www.adfweb.com?Product=HD67810
- www.adfweb.com?Product=HD67811
- www.adfweb.com?Product=HD67812
- www.adfweb.com?Product=HD67813
- www.adfweb.com?Product=HD67814
- www.adfweb.com?Product=HD67818
- www.adfweb.com?Product=HD67820
- www.adfweb.com?Product=HD67821

- (BACnet Master)**
- (BACnet Slave)**
- (CAN)**
- (CANopen)**
- (EtherNet/IP)**
- (DeviceNet Master)**
- (DeviceNet Slave)**
- (J1939)**
- (M-Bus Master/wM-Bus)**
- (Modbus Master)**
- (Modbus Slave)**
- (Modbus TCP Master)**
- (PROFINET Slave)**
- (SNMP)**
- (DMX)**

Do you have an your customer protocol?

www.adfweb.com?Product=HD67003

Do you need to choose a device? do you want help?

www.adfweb.com?Cmd=helpme



User Manual

INDEX:

	Page
INDEX	2
UPDATED DOCUMENTATION	2
REVISION LIST	2
WARNING	2
TRADEMARKS	2
SECURITY ALERT	3
EXAMPLE OF CONNECTION	4
CONNECTION SCHEME	5
CHARACTERISTICS	6
CONFIGURATION	6
POWER SUPPLY	7
FUNCTION MODES	8
LEDS	9
KNX	10
ETHERNET	11
USE OF COMPOSITOR SW67815	12
NEW PROJECT / OPEN PROJECT	13
SOFTWARE OPTIONS	14
SET COMMUNICATION	15
KNX ACCESS	16
UPDATE DEVICE	18
KNX DIAGNOSTIC OVER MODBUS	20
MECHANICAL DIMENSIONS	21
ORDERING INFORMATIONS	22
ACCESSORIES	22
DISCLAIMER	23
OTHER REGULATIONS AND STANDARDS	23
WARRANTIES AND TECHNICAL SUPPORT	24
RETURN POLICY	24

UPDATED DOCUMENTATION:

Dear customer, we thank you for your attention and we remind you that you need to check that the following document is:

- ✚ Updated
- ✚ Related to the product you own

To obtain the most recently updated document, note the “document code” that appears at the top right-hand corner of each page of this document.

With this “Document Code” go to web page www.adfweb.com/download/ and search for the corresponding code on the page. Click on the proper “Document Code” and download the updates.

REVISION LIST:

Revision	Date	Author	Chapter	Description
1.000	20/04/2015	Ff	All	First Release
1.001	11/09/2015	Ff	All	Revision
1.002	26/02/2016	Nt	All	Revision
1.100	17/05/2023	Ln	All	New hardware version

WARNING:

ADFweb.com reserves the right to change information in this manual about our product without warning. ADFweb.com is not responsible for any error this manual may contain.

TRADEMARKS:

All trademarks mentioned in this document belong to their respective owners.

SECURITY ALERT:**GENERAL INFORMATION**

To ensure safe operation, the device must be operated according to the instructions in the manual. When using the device, legal and safety regulation are required for each individual application. The same applies also when using accessories.

INTENDED USE

Machines and systems must be designed so the faulty conditions do not lead to a dangerous situation for the operator (i.e. independent limit switches, mechanical interlocks, etc.).

QUALIFIED PERSONNEL

The device can be used only by qualified personnel, strictly in accordance with the specifications.

Qualified personnel are persons who are familiar with the installation, assembly, commissioning and operation of this equipment and who have appropriate qualifications for their job.

RESIDUAL RISKS

The device is state-of-the-art and is safe. The instruments can represent a potential hazard if they are inappropriately installed and operated by untrained personnel. These instructions refer to residual risks with the following symbol:



This symbol indicates that non-observance of the safety instructions is a danger for people that could lead to serious injury or death and / or the possibility of damage.

CE CONFORMITY

The declaration is made by our company. You can send an email to support@adfweb.com or give us a call if you need it.

EXAMPLE OF CONNECTION:

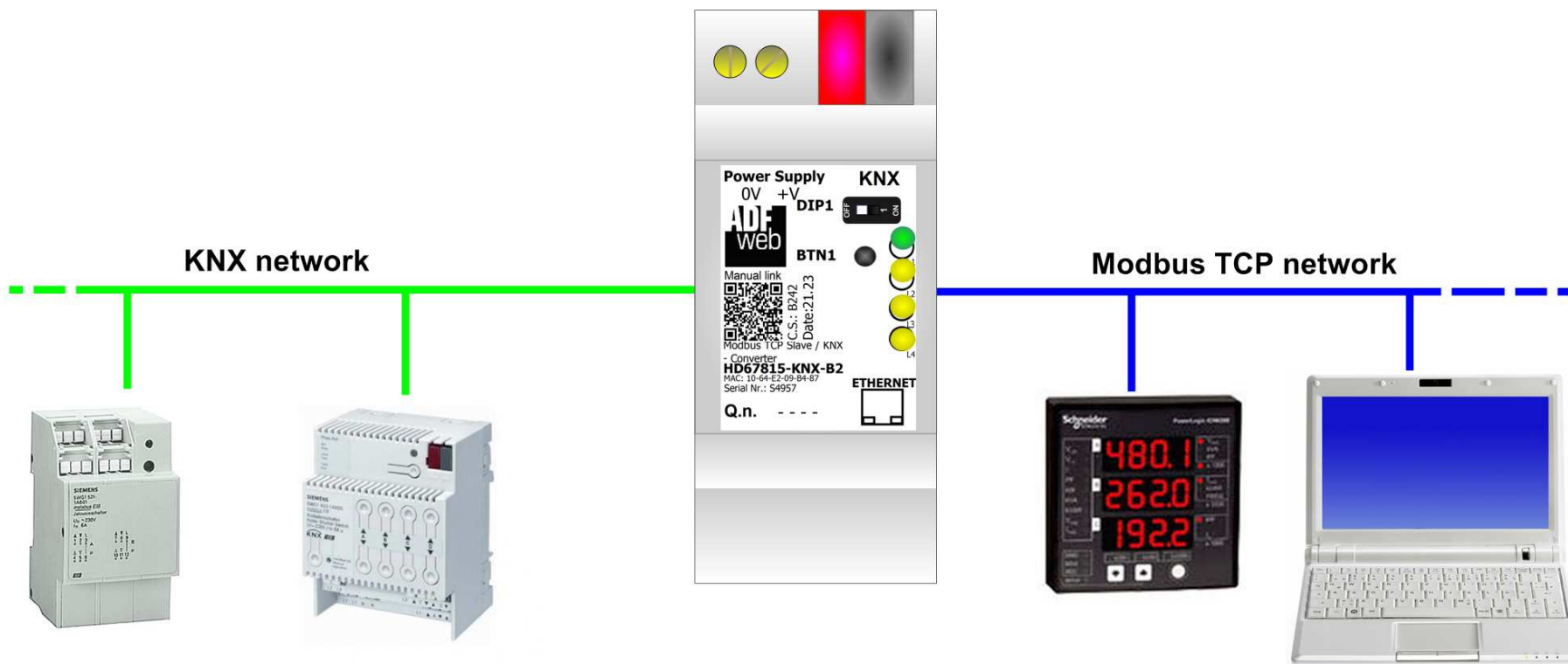

CONNECTION SCHEME:

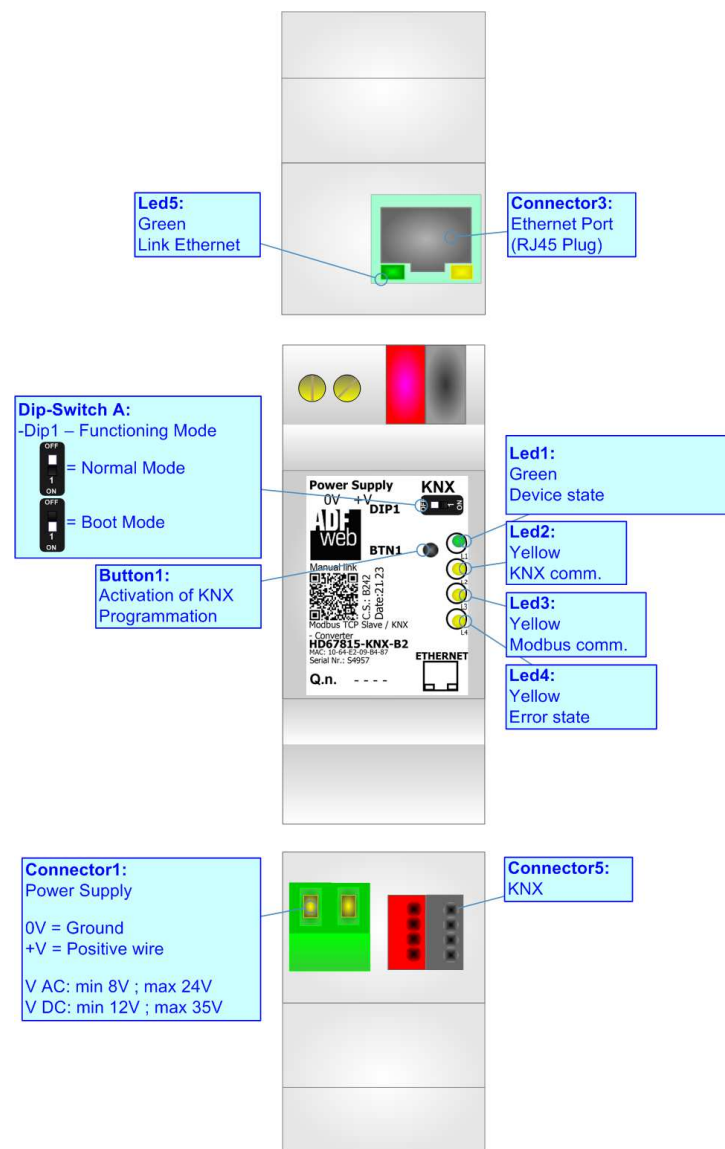

Figure 1: Connection scheme for HD67815-KNX-B2

CHARACTERISTICS:

The HD67815 is a Modbus TCP Slave / KNX Converter.

It has the following characteristics:

- Up to 1440 bytes in reading and 1440 bytes in writing;
- Triple isolation between KNX - Power Supply, KNX - Ethernet, Power Supply - Ethernet.
- Two-directional information between KNX bus and Modbus TCP bus;
- Mountable on 35mm Rail DIN;
- Wide power supply input range: 8...24V AC or 12...35V DC;
- Wide temperature range: -40°C / 85°C [-40°F / +185°F].



CONFIGURATION:

You need Compositor SW67815 software on your PC in order to perform the following:

- Define the parameter of KNX line;
- Define the parameter of Modbus TCP line;
- Update the device.

POWER SUPPLY:

The devices can be powered at 8...24V AC and 12...35V DC. For more details see the two tables below.

VAC 		VDC 	
Vmin	Vmax	Vmin	Vmax
8V	24V	12V	35V

Consumption at 24V DC:

Device	Consumption [W/VA]
HD67815-KNX-B2	3.5

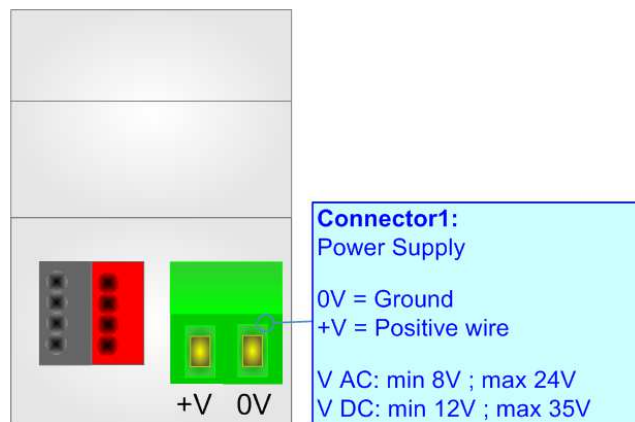

Caution: Not reverse the polarity power

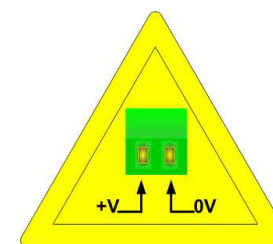

HD67815-KNX-B2

FUNCTION MODES:

The device has got two functions mode depending of the position of the 'Dip1 of Dip-Switch A':

- The first, with 'Dip1 of Dip-Switch A' at "OFF" position, is used for the normal working of the device.
- The second, with 'Dip1 of Dip-Switch A' at "ON" position, is used for upload the Project and/or Firmware.

For the operations to follow for the updating, see 'UPDATE DEVICE' section.

According to the functioning mode, the LEDs will have specifics functions, see 'LEDS' section.

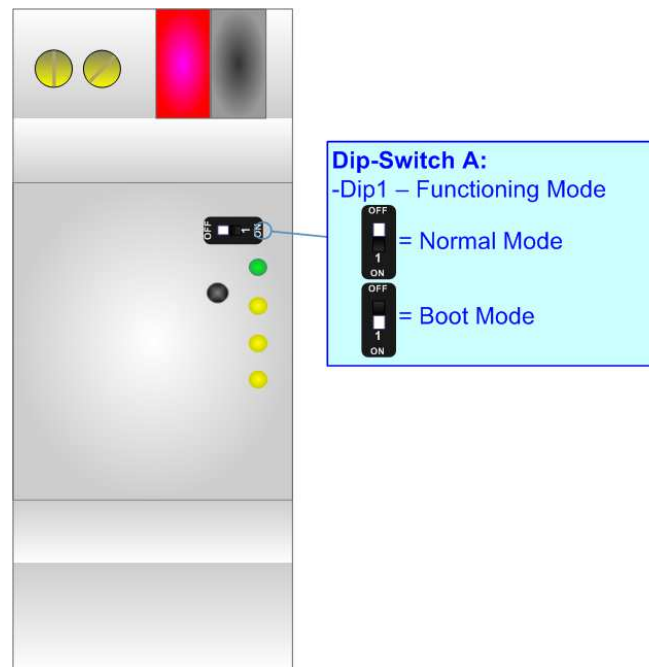

LEDS:

The device has got six LEDs that are used to give information of the functioning status. The various meanings of the LEDs are described in the table below.

LED	Normal Mode	Boot Mode
1: Device State (green)	Blinks slowly (~1Hz)	ON: Device powered OFF: Device not powered
2: KNX communication (yellow)	Blinks when KNX frame is received	
3: Modbus communication (yellow)	Blinks when Modbus TCP frame is received	Blinks quickly: Boot state Blinks very slowly (~0.5Hz): update in progress
4: Error state (yellow)	ON: No Modbus TCP requests are received OFF: No errors are present	Blinks quickly: Boot state Blinks very slowly (~0.5Hz): update in progress
5: Ethernet Link (green)	ON: Ethernet cable connected OFF: Ethernet cable disconnected	ON: Ethernet cable connected OFF: Ethernet cable disconnected

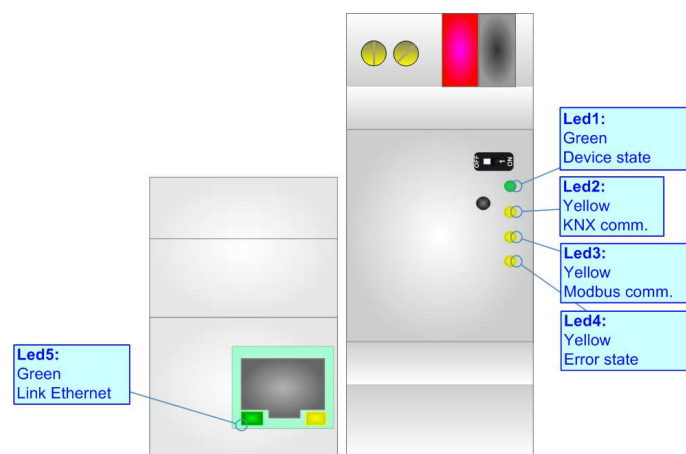

KNX:

KNX is the standard that allows the automated and decentralized management of the technologic plans of a big typology of structures: commercial buildings, factories, houses, public locals, schools and so on.

KNX can be used in all the applications and functions for the building automations: from lighting to control dampers, to the security, to the heating monitoring, to the conditioning, to the hydric control and alarms, to energy management and so on.

Characteristics	Description TP1-256
Medium	Shielded Twisted Pair
Topology	Linear, Star, Tree or mixed
Baudrate	9600 bps
Device supplying	Normal: bus powered devices Optional: remote powered devices
Device power consumption	3 mA- 12 mA
Power Supply Unit (PSU)	DC 30 V
Number of PSU's per physical Segment	Max. 2
Number of connectable devices per physical Segment	Max. 256
Number of addressable devices per physical Segment	Max. 255
Total cable length per physical Segment	Max. 1000 m
Distance between two devices	Max. 700 m

(*) Taken from KNX specifications

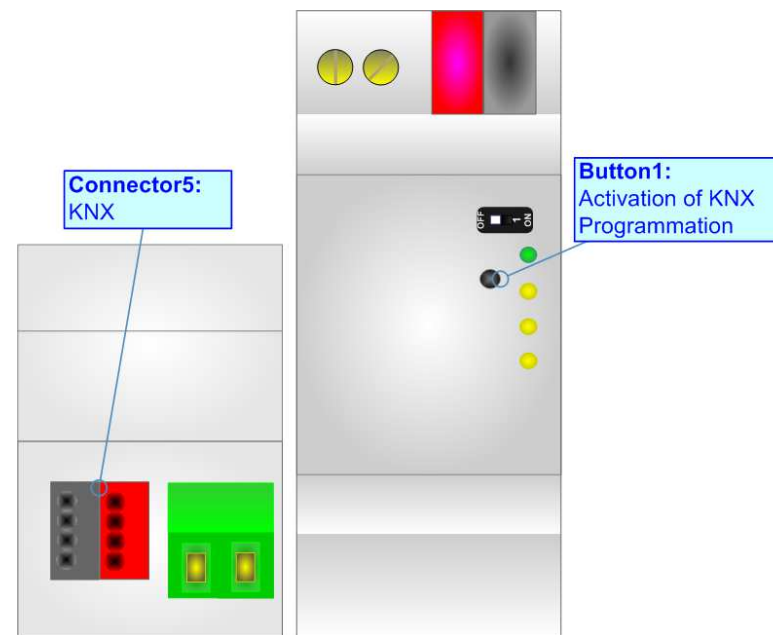

ETHERNET:

The Ethernet port is used for the Modbus TCP communication and for programming the device.

The Ethernet connection must be made using Connector2 of HD67815-KNX-B2 with at least a Category 5E cable. The maximum length of the cable should not exceed 100m. The cable has to conform to the T568 norms relative to connections in cat.5 up to 100 Mbps. To connect the device to an Hub/Switch is recommended the use of a straight cable, to connect the device to a PC is recommended the use of a cross cable.

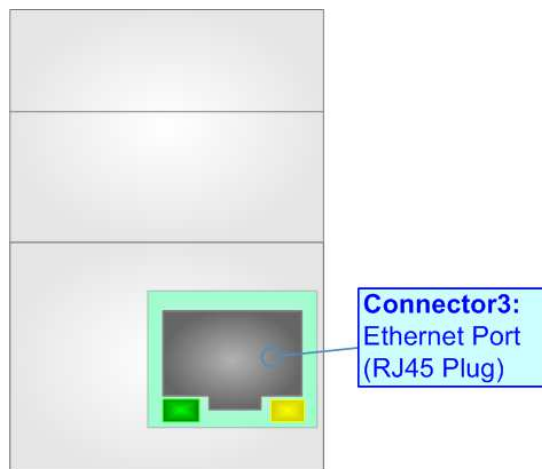

USE OF COMPOSITOR SW67815:

To configure the Converter, use the available software that runs with Windows called SW67815. It is downloadable on the site www.adfweb.com and its operation is described in this document. (*This manual is referenced to the last version of the software present on our web site*). The software works with MSWindows (XP, Vista, Seven, 8, 10 or 11; 32/64bit).

When launching the SW67815, the window below appears (Fig. 2).



Note:

It is necessary to have installed .Net Framework 4.



Figure 2: Main window for SW67815

NEW CONFIGURATION / OPEN CONFIGURATION:

The “**New Configuration**” button creates the folder which contains the entire device’s configuration.

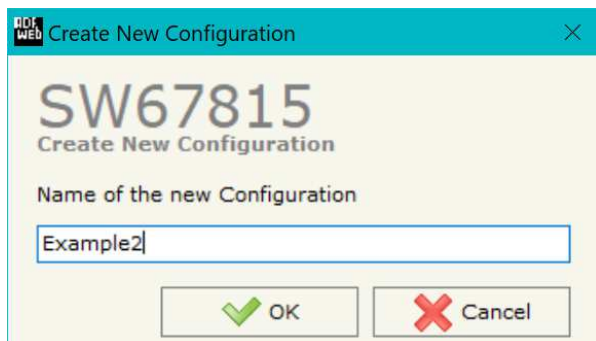

A device’s configuration can also be imported or exported:

- To clone the configurations of a Programmable “Modbus TCP Slave / KNX - Converter” in order to configure another device in the same manner, it is necessary to maintain the folder and all its contents;
- To clone a project in order to obtain a different version of the project, it is sufficient to duplicate the project folder with another name and open the new folder with the button “**Open Configuration**”.

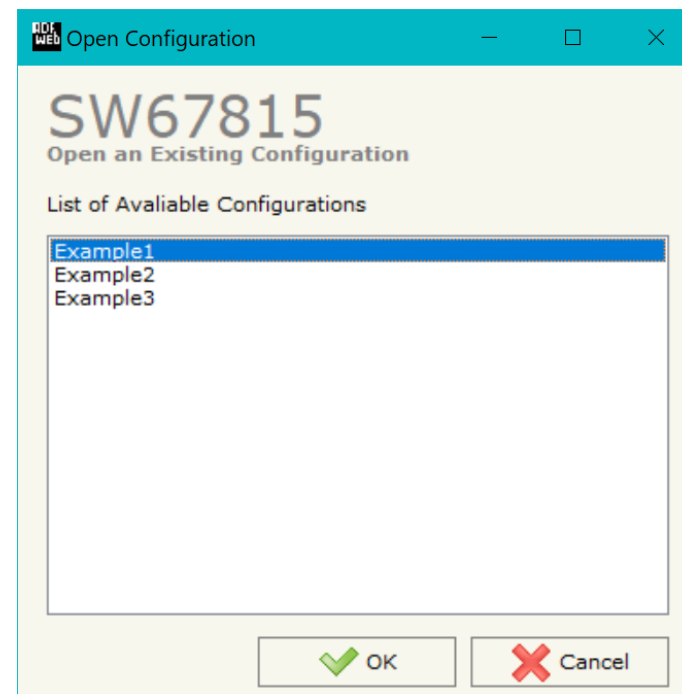

SOFTWARE OPTIONS:

By pressing the “**Settings**” () button there is the possibility to change the language of the software and check the updatings for the compositor.

In the section “Language” it is possible to change the language of the software.

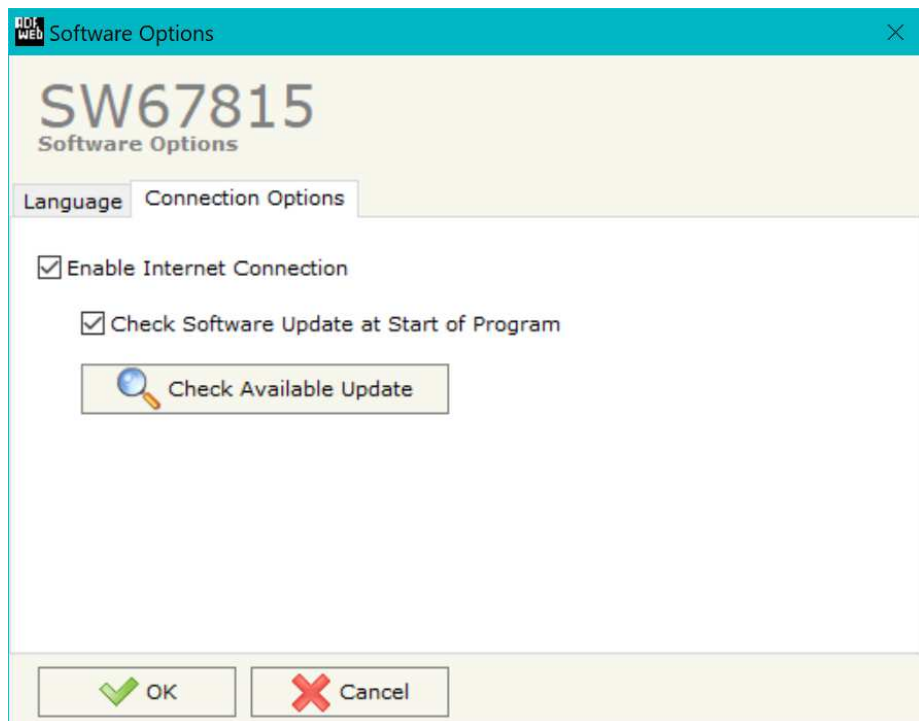

In the section “Connection Options”, it is possible to check if there are some updatings of the software compositor in ADFweb.com website. Checking the option “**Check Software Update at Start of Program**”, the SW67815 check automatically if there are updatings when it is launched.

SET COMMUNICATION:

This section define the fundamental communication parameters of two buses, KNX and Modbus TCP.

By Pressing the **"Set Communication"** button from the main window for SW67815 (Fig. 2) the window "Set Communication" appears (Fig. 3).

The window is divided in two sections, one for the KNX and one for the Modbus TCP.

The means of the fields for "KNX" are:

- In the field **"Type"** the type of KNX is defined (fixd to 'KNX TP');
- In the field **"ID Device"** the ID of the KNX side of the converter is defined.

The means of the fields for the "Modbus TCP Slave" section are:

- In the fields **"IP ADDRESS"** the IP address that you want to give to the Converter is defined;
- In the fields **"SUBNET Mask"** the SubNet Mask is defined;
- In the fields **"GATEWAY"** the default gateway that you want to use is defined. This feature can be enabled or disabled pressing the Check Box field. This feature is used for going out of the net;
- In the field **"Port"** the TCP port for the Modbus TCP communication is defined.
- In the field **"Diagnostic"** insert the starting byte of the memory array where you will save the diagnostic of KNX. It is possible to enable/disable this function using the checkbox. For more informations about the diagnostic, see "Diagnostic" section on page 20.

The screenshot shows a software window titled "Set Communication" for device "SW67815". It contains two main configuration sections. The "KNX" section includes a "Type" dropdown menu currently set to "KNX TP" and an "ID Device" text input field containing "3.3.3". The "Modbus TCP Slave" section includes an "IP ADDRESS" field with the value "192.168.0.10", a "SUBNET Mask" field with "255.255.255.0", a "GATEWAY" section with an unchecked checkbox and a field containing "192.168.0.1", a "Port" field with "502", and a "Diagnostic" section with an unchecked checkbox and a field containing "0". At the bottom of the window are "OK" and "Cancel" buttons.

Figure 3: "Set Communication" window

KNX ACCESS:

By pressing the “**KNX Access**” button from the main window for SW67815 (Fig. 2) the “KNX Access” window appears (Fig. 4).

N	Enable	Source Add	Dest/Group	APCI	Priority	Format	Extended	ReTest	OnCMD	OnChange	OnTimer	Poll Time	Position	Bit Mode	Length	TimeOut	Mnemonic
1	<input checked="" type="checkbox"/>	2.4.8	31/7/255	4	Normal	None	<input type="checkbox"/>	<input type="checkbox"/>	<input type="checkbox"/>	<input type="checkbox"/>	<input checked="" type="checkbox"/>	1000	0	No	2	0	
2	<input checked="" type="checkbox"/>						<input type="checkbox"/>	<input type="checkbox"/>	<input type="checkbox"/>	<input type="checkbox"/>	<input type="checkbox"/>						
3	<input checked="" type="checkbox"/>						<input type="checkbox"/>	<input type="checkbox"/>	<input type="checkbox"/>	<input type="checkbox"/>	<input type="checkbox"/>						
4	<input checked="" type="checkbox"/>						<input type="checkbox"/>	<input type="checkbox"/>	<input type="checkbox"/>	<input type="checkbox"/>	<input type="checkbox"/>						
5	<input checked="" type="checkbox"/>						<input type="checkbox"/>	<input type="checkbox"/>	<input type="checkbox"/>	<input type="checkbox"/>	<input type="checkbox"/>						
6	<input checked="" type="checkbox"/>						<input type="checkbox"/>	<input type="checkbox"/>	<input type="checkbox"/>	<input type="checkbox"/>	<input type="checkbox"/>						
7	<input checked="" type="checkbox"/>						<input type="checkbox"/>	<input type="checkbox"/>	<input type="checkbox"/>	<input type="checkbox"/>	<input type="checkbox"/>						
8	<input checked="" type="checkbox"/>						<input type="checkbox"/>	<input type="checkbox"/>	<input type="checkbox"/>	<input type="checkbox"/>	<input type="checkbox"/>						
9	<input checked="" type="checkbox"/>						<input type="checkbox"/>	<input type="checkbox"/>	<input type="checkbox"/>	<input type="checkbox"/>	<input type="checkbox"/>						

Figure 4: “KNX Set Access” window

The means of the fields are:

- ✦ If the field “**Enable**” is checked, the KNX message is enabled;
- ✦ In the field “**Source Address**” the Source Address to assign to the KNX message is defined;
- ✦ In the field “**Dest/Group**” the Group address (2 level structure, 3 level structure or free address structure) or the device address is defined. In case of Group address, the levels must be separated by ‘/’, in case of Device address, the parts of the address must be separated by ‘.’;
- ✦ In the field “**APCI**” the APCI of the KNX message is defined. You can choose between the following:
 - Read: it is used to send a reading request to a KNX device;
 - Write: it is used to send a writing request to a KNX device;
 - Specific value (edited manually).

- ✦ In the field "**Priority**" the Priority of the KNX message is defined. You can choose between the following:
 - System (Highest);
 - Urgent;
 - Normal;
 - Low (Lowest).
- ✦ In the field "**Format**" the data format of the KNX message is defined;
- ✦ If the field "**Extended**" is checked, the extended format of the KNX message is used;
- ✦ If the field "**ReTest**" is checked, the KNX message is re-sent in case of not correct response;
- ✦ If the field "**On CMD**" is checked, the gateway sends the KNX command when a Modbus request is received;
- ✦ If the field "**On Change**" is checked, the gateway sends the KNX command when the data on Modbus change the value;
- ✦ If the field "**On Timer**" is checked, the gateway sends the KNX command cyclically;
- ✦ In the field "**Poll Time**" the delay in ms between two KNX commands is defined (if "On Timer" is checked);
- ✦ In the field "**Position**" insert the address of the internal array where placing the information;
- ✦ In the field "**Bit Mode**" insert the start bit of the first byte of the field "Position" where start to insert the data read;
- ✦ In the field "**Lenght**" the dimension of the KNX message is defined;
- ✦ In the field "**Timeout**" the timeout in ms for KNX data point is defined. If the data point is not received for the time defined, the data on Modbus side are set to '0';
- ✦ In the field "**Mnemonic**" the description for the request is defined.

**Note:**

If the field "On change" is checked and the "Poll Time" is different from 0, the converter sends the KNX command cyclically and also when the data is changed.

**Note:**

If the fields "On CMD", "OnChange" and "OnTimer" are not checked, the converter only sniffs the bus in order to monitor the status of the KNX message.

UPDATE DEVICE:

By pressing the **"Update Device"** button, it is possible to load the created Configuration into the device; and also the Firmware, if necessary. This by using the Ethernet port.

If you don't know the actual IP address of the device you have to use this procedure:

- Turn OFF the Device;
- Put Dip1 of 'Dip-Switch A' in ON position;
- Turn ON the device
- Connect the Ethernet cable;
- Insert the IP **"192.168.2.205"**;
- Select which operations you want to do;
- Press the **"Execute update firmware"** button to start the upload;
- When all the operations are "OK" turn OFF the Device;
- Put Dip1 of 'Dip-Switch A' in OFF position;
- Turn ON the device.

If you know the actual IP address of the device, you have to use this procedure:

- Turn ON the Device with the Ethernet cable inserted;
- Insert the actual IP of the Converter;
- Select which operations you want to do;
- Press the **"Execute update firmware"** button to start the upload;
- When all the operations are "OK" the device automatically goes at Normal Mode.

At this point the configuration/firmware on the device is correctly updated.

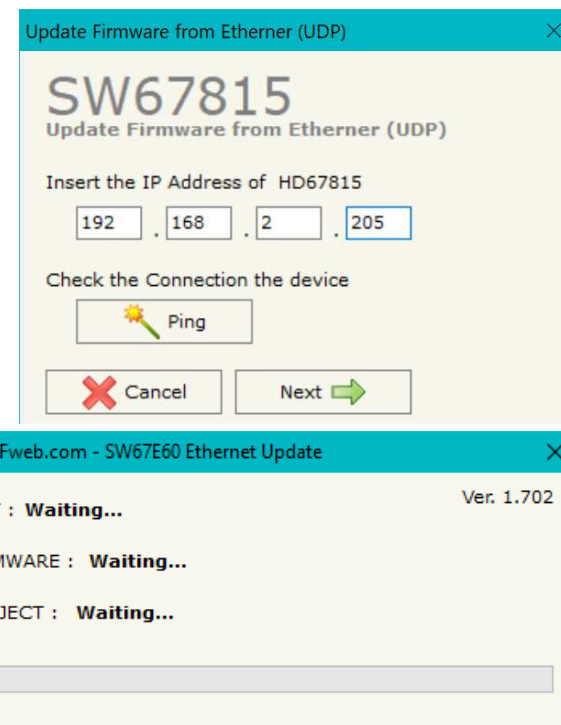

Figure 5: "Update device" windows

**Note:**

When you receive the device, for the first time, you also have to update the Firmware in the HD67815 device.

**Warning:**

If Fig. 6 appears when you try to do the Update try these points before seeking assistance:

- Try to repeat the operations for the updating;
- Try with another PC;
- Try to restart the PC;
- Check the LAN settings;
- If you are using the program inside a Virtual Machine, try to use in the main Operating System;
- If you are using Windows Seven, Vista, 8 or 10 or 11 make sure that you have the administrator privileges;
- In case you have to program more than one device, using the "UDP Update", you have to cancel the ARP table every time you connect a new device on Ethernet. For do this you have to launch the "Command Prompt" and write the command "arp -d". Pay attention that with Windows Vista, Seven, 8, 10 or 11 you have to launch the "Command Prompt" with Administrator Rights;
- Pay attention at Firewall lock.

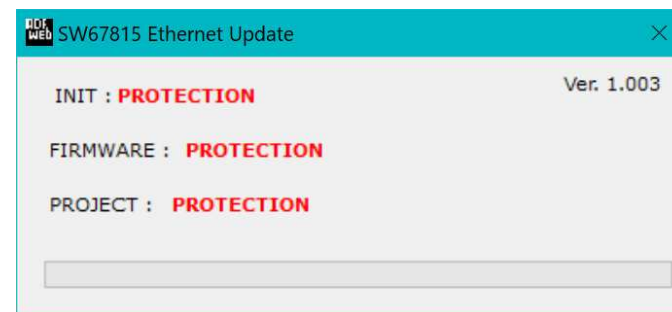

Figure 6: "Error" window

**Warning:**

In the case of HD67815 you have to use the software "HD67815": www.adfweb.com/download/filefold/SW67815.zip.

KNX DIAGNOSTIC OVER MODBUS:

It is possible to save the KNX Diagnostic on Output Modbus array using the field "Diagnostic" of the section "Set Communication". In this case, the status of each KNX message defined in the section "KNX Access" is saved starting from the byte of the memory array defined in the section "Set Communication".

Each bit will represent the status of a KNX request:

- If the converter receives a correct message before the timeout, the status bit is put to '0';
- If the converter doesn't receive a correct message before the timeout, the status bit is put to '1'.

Example:

In the section "KNX Access", 16 KNX messages are defined. First 8 KNX messages are received in the timeout and the last 8 are not working.

The status bits of the KNX Diagnostic on Modbus will be:

Byte x								Byte x+1							
bit7	bit6	bit5	bit4	bit3	bit2	bit1	bit0	bit7	bit6	bit5	bit4	bit3	bit2	bit1	bit0
0	0	0	0	0	0	0	0	1	1	1	1	1	1	1	1

where 'x' is the starting byte of the memory array where the KNX diagnostic is saved.

MECHANICAL DIMENSIONS:

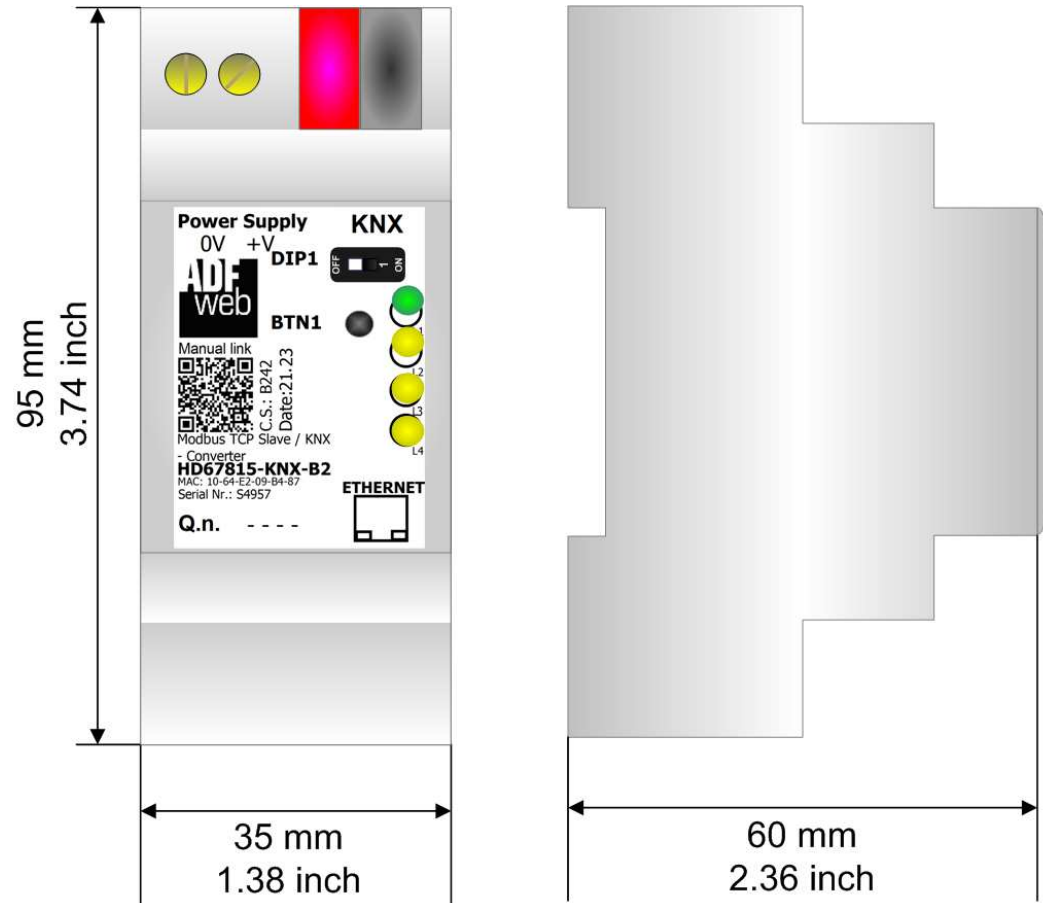

Housing: PVC
 Weight: 200g
 (Approx)

Figure 7: Mechanical dimensions scheme for HD67815-KNX-B2

ORDERING INFORMATIONS:

The ordering part number is formed by a valid combination of the following:

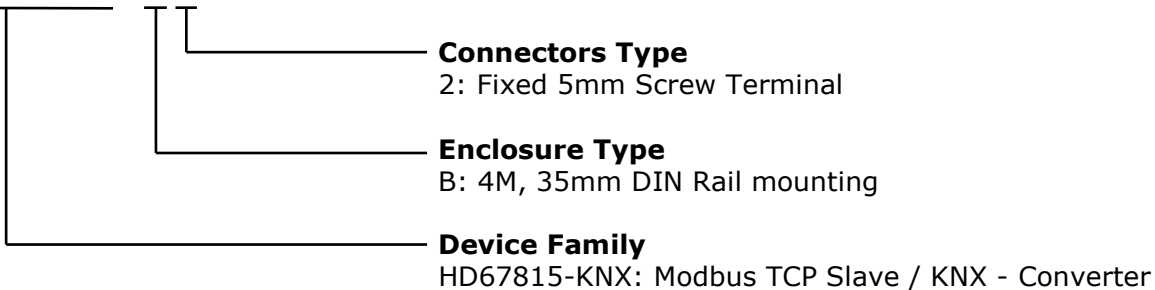
HD67815 – KNX – B 2

Order Code: **HD67815-KNX-B2** - Modbus TCP Slave / KNX – Converter

ACCESSORIES:

Order Code: **AC34001** - 35mm Rail DIN - Power Supply 220/240V AC 50/60Hz – 12 V AC

Order Code: **AC34002** - 35mm Rail DIN - Power Supply 110V AC 50/60Hz – 12 V AC

DISCLAIMER:

All technical content within this document can be modified without notice. The content of the document is a under continual renewal. For losses due to fire, earthquake, third party access or other accidents, or intentional or accidental abuse, misuse, or use under abnormal conditions repairs are charged to the user. ADFweb.com S.r.l. will not be liable for accidental loss of use or inability to use this product, such as loss of business income. ADFweb.com S.r.l. shall not be liable for consequences of improper use.

OTHER REGULATIONS AND STANDARDS:**WEEE INFORMATION**

Disposal of old electrical and electronic equipment (as in the European Union and other European countries with separate collection systems).

— This symbol on the product or on its packaging indicates that this product may not be treated as household rubbish. Instead, it should be taken to an applicable collection point for the recycling of electrical and electronic equipment. If the product is disposed correctly, you will help prevent potential negative environmental factors and impact of human health, which could otherwise be caused by inappropriate disposal. The recycling of materials will help to conserve natural resources. For more information about recycling this product, please contact your local city office, your household waste disposal service or the shop where you purchased the product.

RESTRICTION OF HAZARDOUS SUBSTANCES DIRECTIVE

The device respects the 2002/95/EC Directive on the restriction of the use of certain hazardous substances in electrical and electronic equipment (commonly referred to as Restriction of Hazardous Substances Directive or RoHS).

CE MARKING

The product conforms with the essential requirements of the applicable EC directives.

WARRANTIES AND TECHNICAL SUPPORT:

For fast and easy technical support for your ADFweb.com SRL products, consult our internet support at www.adfweb.com.
Otherwise contact us at the address support@adfweb.com

RETURN POLICY:

If while using your product you have any problem and you wish to exchange or repair it, please do the following:

- Obtain a Product Return Number (PRN) from our internet support at www.adfweb.com. Together with the request, you need to provide detailed information about the problem.
- Send the product to the address provided with the PRN, having prepaid the shipping costs (shipment costs billed to us will not be accepted).

If the product is within the warranty of twelve months, it will be repaired or exchanged and returned within three weeks. If the product is no longer under warranty, you will receive a repair estimate.



ADFweb.com S.r.l.
Via Strada Nuova, 17
IT-31010 Mareno di Piave
TREVISO (Italy)
Phone +39.0438.30.91.31
Fax +39.0438.49.20.99
www.adfweb.com

