

# User Manual

Revision 1.000  
English

## MQTT / HART Master - Converter

(Order Code: HD67910-A1)

For Website information:

[www.adfweb.com?Product=HD67910](http://www.adfweb.com?Product=HD67910)

For Price information:

[www.adfweb.com?Price=HD67910-A1](http://www.adfweb.com?Price=HD67910-A1)

### Benefits and Main Features:

- ⊕ Very easy to configure
- ⊕ Triple Electrical isolation
- ⊕ Temperature range: -40°C/+85°C (-40°F/+185°F)

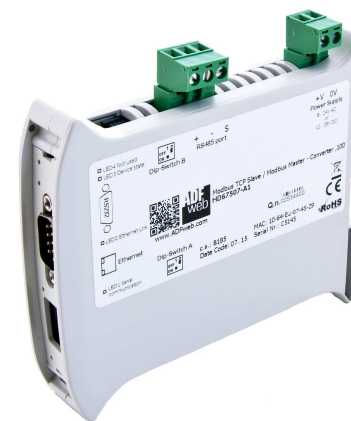

For other HART products see also the following link:

### Converter IEC 61850 Server to

- [www.adfweb.com?Product=HD67900](http://www.adfweb.com?Product=HD67900)
- [www.adfweb.com?Product=HD67901](http://www.adfweb.com?Product=HD67901)
- [www.adfweb.com?Product=HD67902](http://www.adfweb.com?Product=HD67902)
- [www.adfweb.com?Product=HD67903](http://www.adfweb.com?Product=HD67903)
- [www.adfweb.com?Product=HD67904](http://www.adfweb.com?Product=HD67904)
- [www.adfweb.com?Product=HD67905](http://www.adfweb.com?Product=HD67905)
- [www.adfweb.com?Product=HD67906](http://www.adfweb.com?Product=HD67906)
- [www.adfweb.com?Product=HD67908](http://www.adfweb.com?Product=HD67908)
- [www.adfweb.com?Product=HD67909](http://www.adfweb.com?Product=HD67909)
- [www.adfweb.com?Product=HD67910](http://www.adfweb.com?Product=HD67910)
- [www.adfweb.com?Product=HD67912](http://www.adfweb.com?Product=HD67912)
- [www.adfweb.com?Product=HD67913](http://www.adfweb.com?Product=HD67913)

- (Serial)**
- (BACnet Slave)**
- (CAN)**
- (CANopen)**
- (DeviceNet Slave)**
- (Ethernet)**
- (EtherNet/IP Slave)**
- (Modbus Slave)**
- (Modbus TCP Slave)**
- (MQTT)**
- (PROFINET Slave)**
- (SNMP Agent)**

Do you have your customer protocol? Then go to:

[www.adfweb.com?Product=HD67003](http://www.adfweb.com?Product=HD67003)

Do you need to choose a device? Do you want help?

[www.adfweb.com?Cmd=helpme](http://www.adfweb.com?Cmd=helpme)



User Manual

**INDEX:**

	Page
INDEX	2
UPDATED DOCUMENTATION	2
REVISION LIST	2
WARNING	2
TRADEMARKS	2
SECURITY ALERT	3
EXAMPLE OF CONNECTION	4
CONNECTION SCHEME	5
CHARACTERISTICS	6
CONFIGURATION	6
POWER SUPPLY	7
FUNCTION MODES	8
LEDS	9
HART	10
ETHERNET	11
USE OF COMPOSITOR SW67910	12
NEW CONFIGURATION / OPEN CONFIGURATION	13
SOFTWARE OPTIONS	14
SET COMMUNICATION	16
HART VARIABLES	20
MQTT SET TOPICS	22
UPDATE DEVICE	24
SCAN FUNCTION	26
TEMPLATE STRING: DEFINITION OF MQTT PAYLOAD	32
MECHANICAL DIMENSIONS	33
ORDERING INFORMATIONS	34
ACCESSORIES	34
DISCLAIMER	35
OTHER REGULATIONS AND STANDARDS	35
WARRANTIES AND TECHNICAL SUPPORT	36
RETURN POLICY	36

**UPDATED DOCUMENTATION:**

Dear customer, we thank you for your attention and we remind you that you need to check that the following document is:

- Updated
- Related to the product you own

To obtain the most recently updated document, note the “document code” that appears at the top right-hand corner of each page of this document.

With this “Document Code” go to web page [www.adfweb.com/download/](http://www.adfweb.com/download/) and search for the corresponding code on the page. Click on the proper “Document Code” and download the updates.

**REVISION LIST:**

Revision	Date	Author	Chapter	Description
1.000	18/09/2020	Ff	All	First Release

**WARNING:**

ADFweb.com reserves the right to change information in this manual about our product without warning.  
ADFweb.com is not responsible for any error this manual may contain.

**TRADEMARKS:**

All trademarks mentioned in this document belong to their respective owners.

**SECURITY ALERT:****GENERAL INFORMATION**

To ensure safe operation, the device must be operated according to the instructions in the manual. When using the device, legal and safety regulation are required for each individual application. The same applies also when using accessories.

**INTENDED USE**

Machines and systems must be designed so the faulty conditions do not lead to a dangerous situation for the operator (i.e. independent limit switches, mechanical interlocks, etc.).

**QUALIFIED PERSONNEL**

The device can be used only by qualified personnel, strictly in accordance with the specifications. Qualified personnel are persons who are familiar with the installation, assembly, commissioning and operation of this equipment and who have appropriate qualifications for their job.

**RESIDUAL RISKS**

The device is state-of-the-art and is safe. The instruments can represent a potential hazard if they are inappropriately installed and operated by untrained personnel. These instructions refer to residual risks with the following symbol:



This symbol indicates that non-observance of the safety instructions is a danger for people that could lead to serious injury or death and / or the possibility of damage.

**CE CONFORMITY**

The declaration is made by our company. You can send an email to [support@adfweb.com](mailto:support@adfweb.com) or give us a call if you need it.

**EXAMPLES OF CONNECTION:**

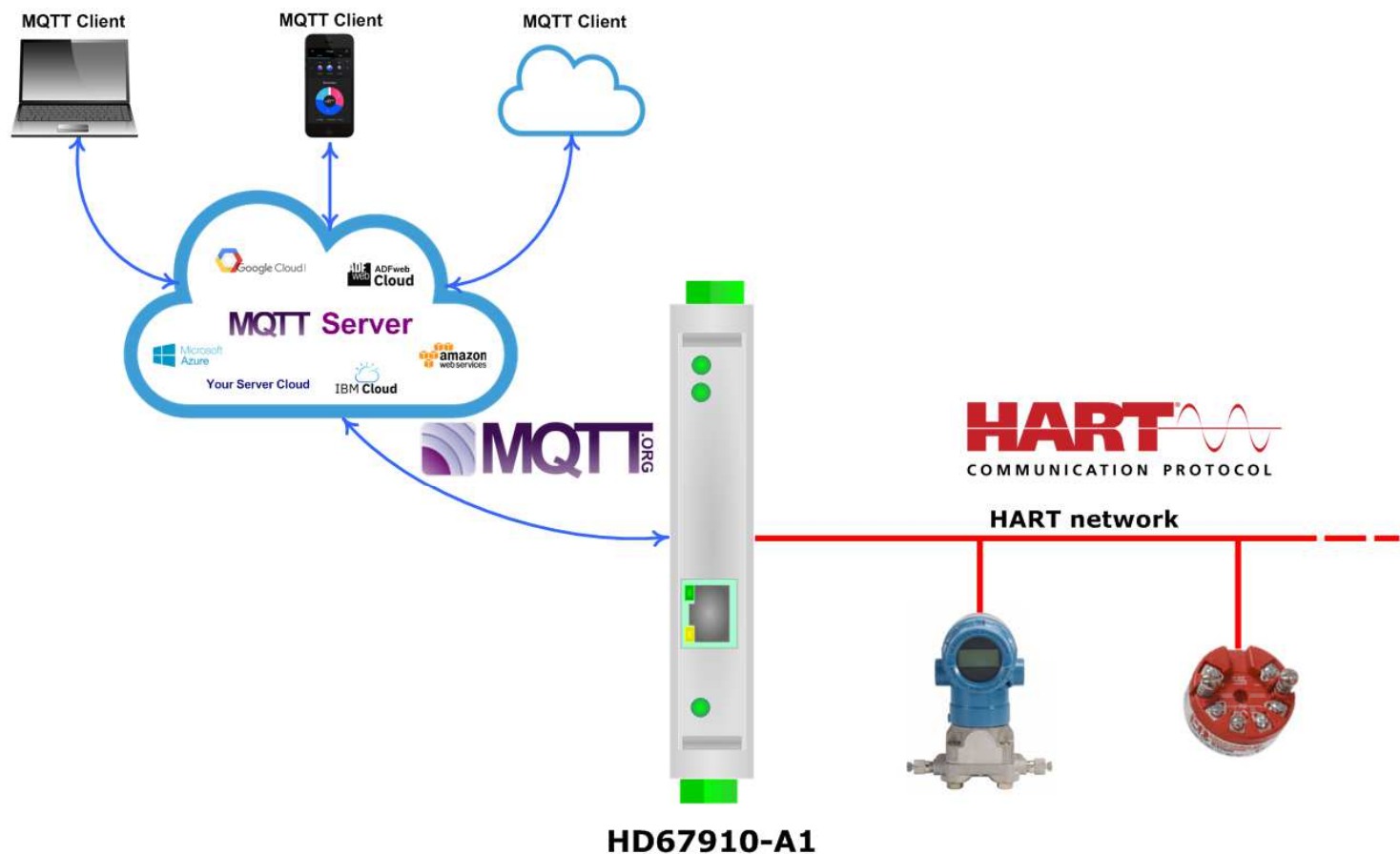

**ADFweb.com**  
 tel. +39 - 0438.30.91.31  
[www.adfweb.com](http://www.adfweb.com)  
[info@adfweb.com](mailto:info@adfweb.com)

**CONNECTION SCHEME:**

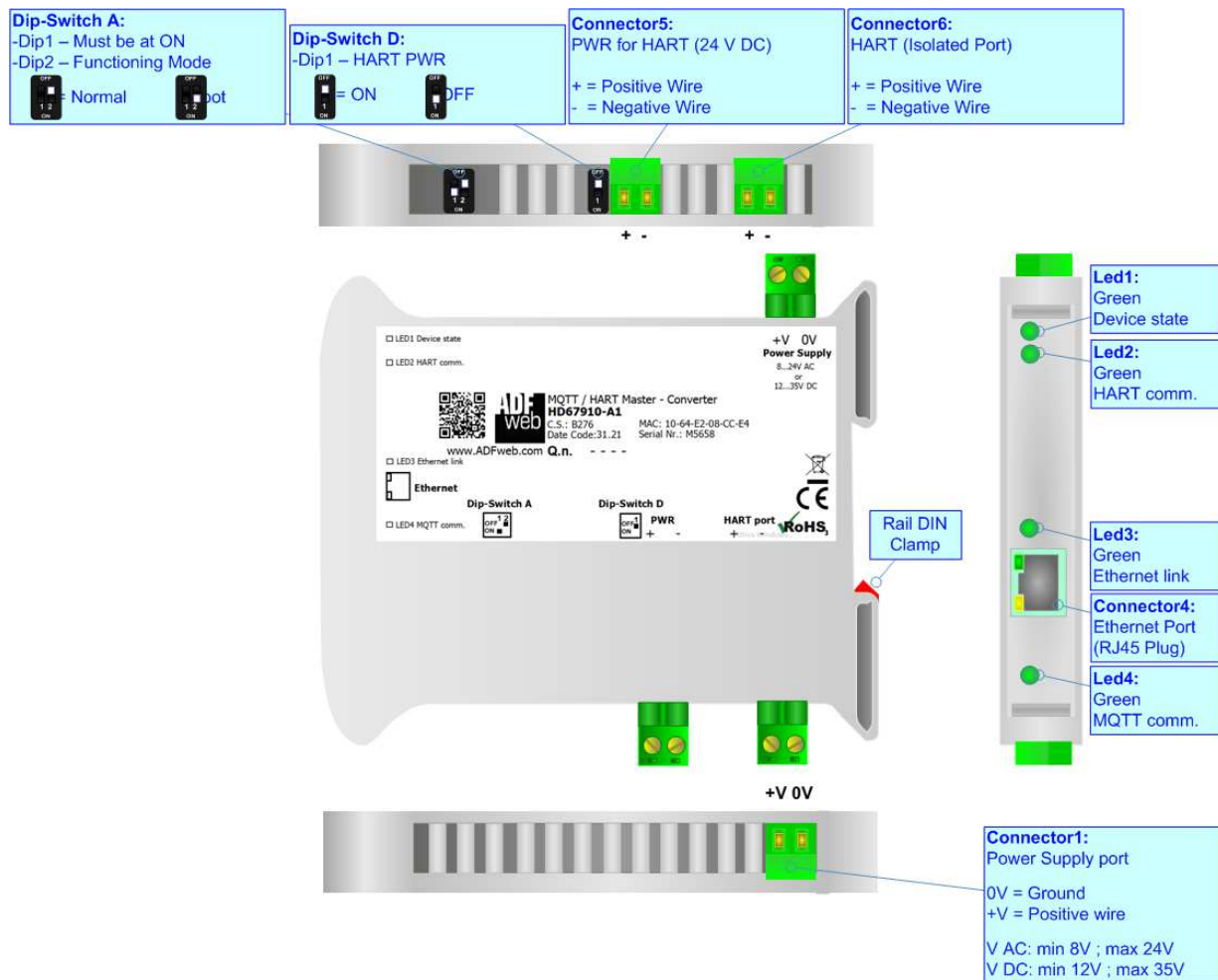

Figure 1: Connection scheme for HD67910-A1

**CHARACTERISTICS:**

The HD67910-A1 are MQTT / HART Master - Converters.

It allows for the following characteristics:

- Triple isolation between Ethernet - Power Supply, Ethernet - HART, HART - Power Supply;
- Two-directional information between Ethernet bus and HART bus;
- Mountable on 35mm Rail DIN;
- Wide power supply input range: 8...24V AC or 12...35V DC;
- Wide temperature range: -40°C / 85°C [-40°F / +185°F].



**CONFIGURATION:**

You need Compositor SW67910 software on your PC in order to perform the following:

- Define the parameters of MQTT;
- Define the parameters of HART line;
- Define HART variables in read/write;
- Define the MQTT topics to be published/subscribed in the MQTT Server;
- Update the device.

**POWER SUPPLY:**

The devices can be powered at 8...24V AC and 12...35V DC. For more details see the two tables below.

VAC 		VDC 	
Vmin	Vmax	Vmin	Vmax
8V	24V	12V	35V

Consumption at 24V DC:

Device	Consumption [W/VA]
HD67910-A1	3.5

**Connector1:**  
 Power Supply port  
 0V = Ground  
 +V = Positive wire  
 V AC: min 8V ; max 24V  
 V DC: min 12V ; max 35V



**Caution: Do not reverse the polarity power**

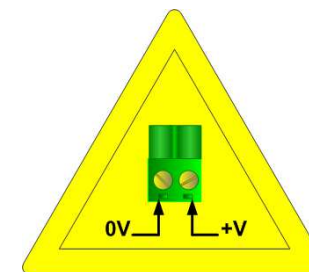

HD67910-A1

**FUNCTION MODES:**

The device has got two function modes depending on the position of the 'Dip2 of Dip-Switch A':

- The first, with 'Dip2 of Dip-Switch A' at "OFF" position, is used for the normal working of the device.
- The second, with 'Dip2 of Dip-Switch A' at "ON" position, is used for uploading the Project and/or Firmware.

For the operations to follow for the updating, see 'UPDATE DEVICE' section.

According to the functioning mode, the LEDs will have specific functions, see 'LEDS' section.

**Warning:**

Dip1 of 'Dip-Switch A' must be at ON position to work even if the Ethernet cable is not inserted.



**LEDS:**

The device has got six LEDs that are used to give information about the functioning status.  
The various meanings of the LEDs are described in the table below.

LED	Normal Mode	Boot Mode
1: Device State (green)	Blinks slowly (~1Hz)	<b>Blinks quickly:</b> Boot state <b>Blinks very slowly (~0.5Hz):</b> update in progress
1: HART communication (green)	It blinks when HART communication is running	<b>Blinks quickly:</b> Boot state <b>Blinks very slowly (~0.5Hz):</b> update in progress
2: Ethernet link (green)	<b>ON:</b> Ethernet cable connected <b>OFF:</b> Ethernet cable disconnected	<b>ON:</b> Ethernet cable connected <b>OFF:</b> Ethernet cable disconnected
4: MQTT communication (green)	It blinks when an MQTT message is received	<b>Blinks quickly:</b> Boot state <b>Blinks very slowly (~0.5Hz):</b> update in progress

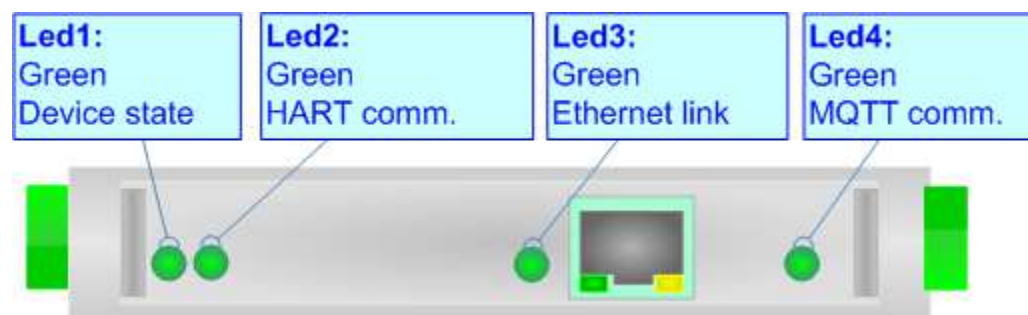

**HART:**

“HART” is an acronym for Highway Addressable Remote Transducer. The HART Protocol makes use of Frequency Shift Keying (FSK) standard to superimpose digital communication signals at a low level on top of the 4-20mA. This enables two-way field communication to take place and makes it possible for additional information beyond just the normal process variable to be communicated to/from a smart field instrument.

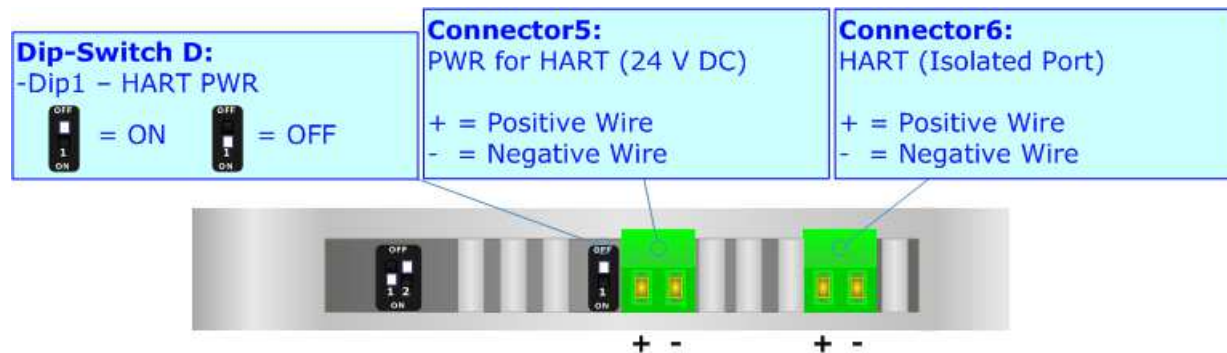

It is possible to provide the current loop for HART communication and an additional low power supply @ 24 V DC for feeding HART devices by setting Dip-Switch D at ON position. Current loop for HART is required when there is not an external device in the bus that provides it.

**ETHERNET:**

The updating of the converters and Ethernet communication must be made using Connector4 of the HD67910-A1 with at least a Category 5E cable. The maximum length of the cable should not exceed 100m. The cable has to conform to the T568 norms relative to connections in cat.5 up to 100 Mbps. To connect the device to an Hub/Switch is recommended the use of a straight cable, to connect the device to a PC/PLC/other is recommended the use of a cross cable.

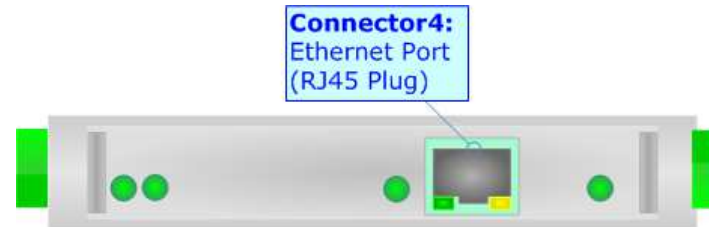

**USE OF COMPOSITOR SW67910:**

To configure the Converter, use the available software that runs with Windows called SW67910. It is downloadable on the site [www.adfweb.com](http://www.adfweb.com) and its operation is described in this document. *(This manual is referenced to the last version of the software present on our web site).* The software works with MSWindows (XP, Vista, Seven, 8, 10; 32/64bit).

When launching the SW67910, the window below appears (Fig. 2).

 **Note:**  
It is necessary to have installed .Net Framework 4.

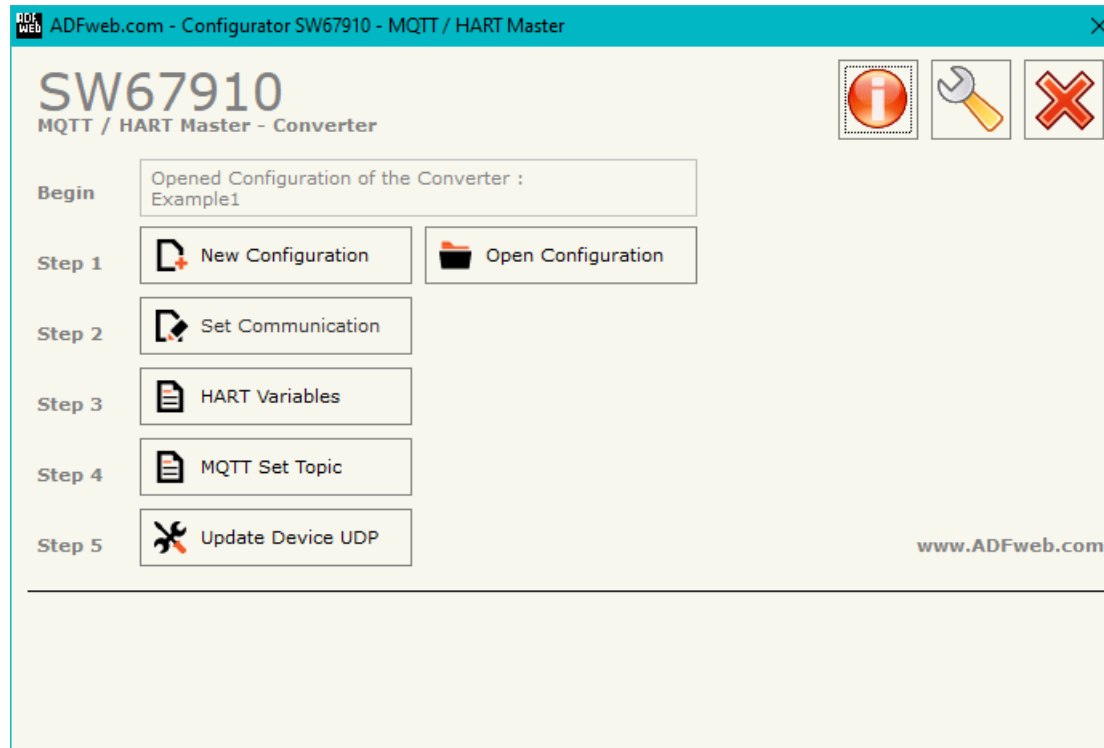
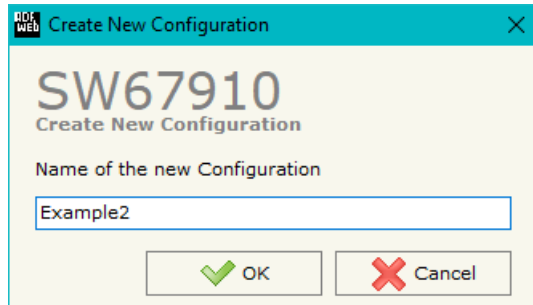

Figure 2: Main window for SW67910

**NEW CONFIGURATION / OPEN CONFIGURATION:**

The “**New Configuration**” button creates the folder which contains the entire device’s configuration.



A device’s configuration can also be imported or exported:

- To clone the configurations of a programmable “MQTT / HART Master” in order to configure another device in the same manner, it is necessary to maintain the folder and all its contents;
- To clone a project in order to obtain a different version of the project, it is sufficient to duplicate the project folder with another name and open the new folder with the button “**Open Configuration**”.

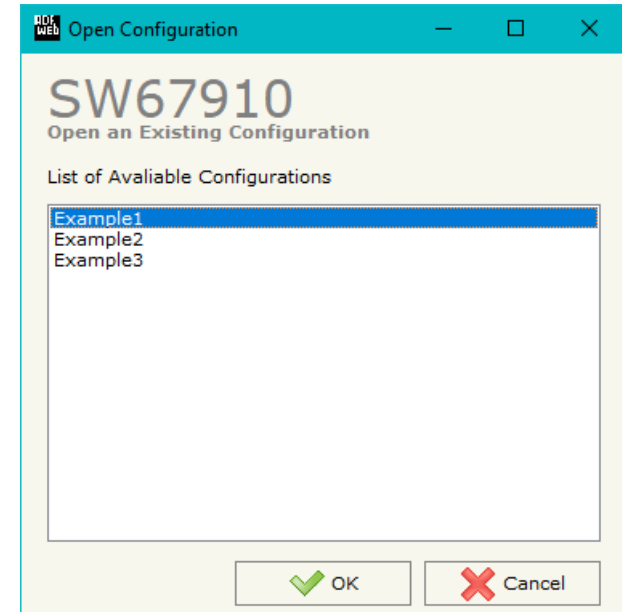

**SOFTWARE OPTIONS:**

By pressing the “**Settings**” () button there is the possibility to change the language of the software and check the updatings for the compositor.

In the section “Language” it is possible to change the language of the software.

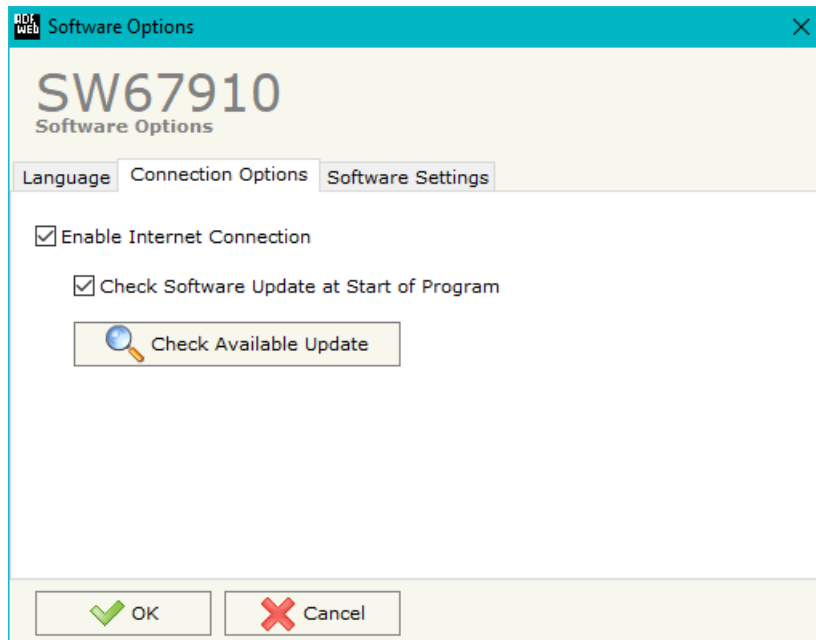

In the section “Connection Options”, it is possible to check if there are some updatings of the software compositor in ADFweb.com website. Checking the option “**Check Software Update at Start of Program**”, the SW67910 checks automatically if there are updatings when it is launched.

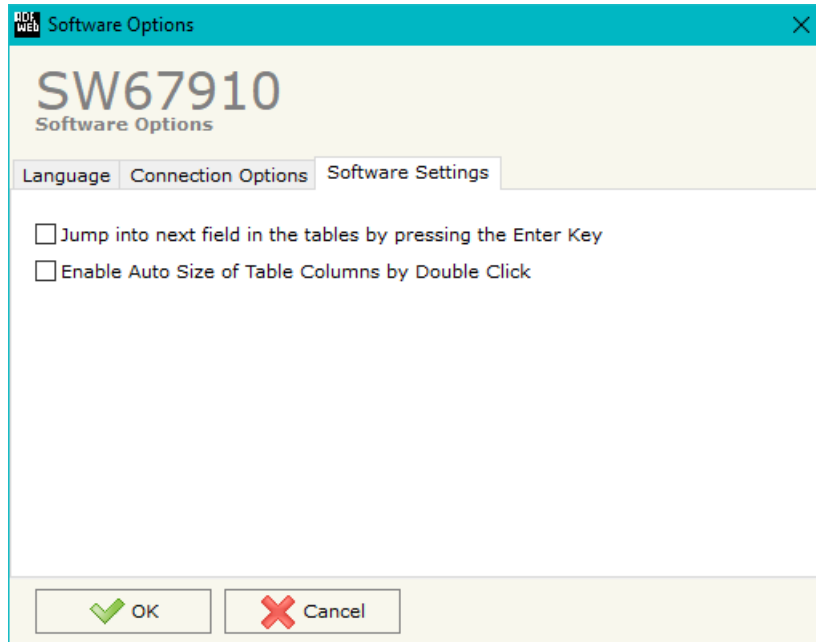

In the section "Software Settings", it is possible to enable/disable some keyboard's commands for an easier navigation inside the tables contained in the different sections of the software.

**SET COMMUNICATION:**

By Pressing the "**Set Communication**" button from the main window for SW67910 (Fig. 2) the window "Set Communication" appears (Fig. 3).

The window is divided in different sections in order to define the different parameters of the converter:

- ➔ HART Master
- ➔ MQTT
- ➔ Ethernet
- ➔ TLS (Transport Layer Security)
- ➔ NTP (Network Time Protocol)
- ➔ Web Pages

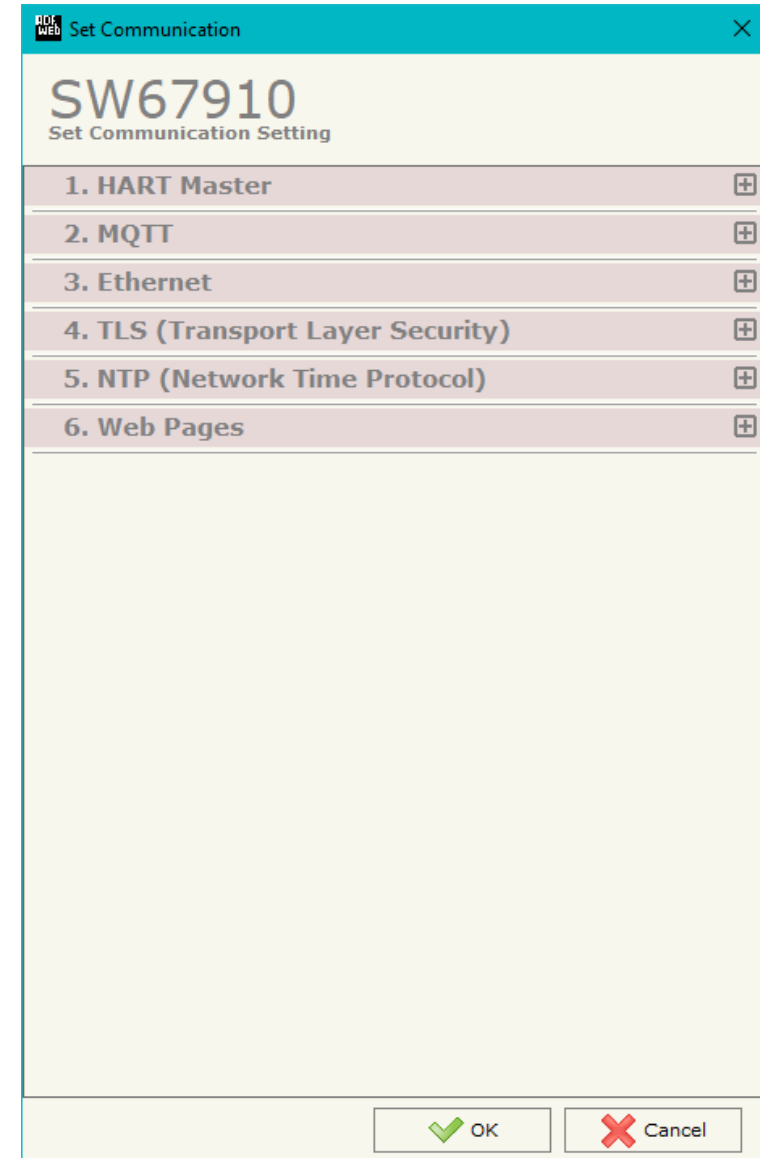

Figure 3a: "Set Communication" window



### **HART MASTER:**

This section is used to define the main parameters of HART Master line. The means of the fields are:

- In the field "**Address**" the type of Master is defined;
- In the field "**Retry Limit**" the maximum number of retries in case of missing response from HART device is defined;

### **MQTT:**

This section is used to define the main parameters of MQTT line. The means of the fields are:

- In the field "**Server URL**" the URL or the IP Address of the MQTT Server is defined;
- In the field "**Server Port**" the port used for MQTT communication is defined;
- In the field "**Client ID**" the Client ID of the converter is defined (if ned);
- In the field "**Keep Alive (seconds)**" the delay with which the Keep Alive message is sent on MQTT is defined;
- If the field "**Clean Session**" is checked, the last MQTT messages are deleted by the Server and the Client in case of missing ACK. If unchecked, the Server and the Client hold the last MQTT messages and, in case of incorrect disconnection or missing ACK, they try to send again them since all the ACK messages are exchanged correctly (valid only for QoS 1 and QoS 2);
- If the field "**Will Flag**" is checked, the converter will publish the Will topic at the connection to the Server. With this feature, in case of incorrect disconnection, the Server will publish this topic to all the MQTT Clients that subscribed it;
- In the field "**Topic Name Will**" the topic used for Will message is defined;
- In the field "**Message Will**" the payload of the Will message is defined;
- In the field "**Retained Will**" the converter will send the Will message with Retain flag enabled. In this way, the Server will hold the last Will message;
- In the field "**QoS Will**" the QoS type for Will message is defined;
- In the field "**Username**" the username for the connection to the MQTT server is defined;

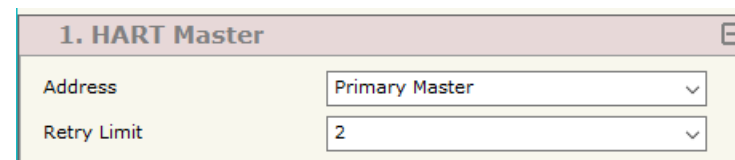

1. HART Master	
Address	Primary Master
Retry Limit	2

Figure 3b: "Set Communication → HART Master" window

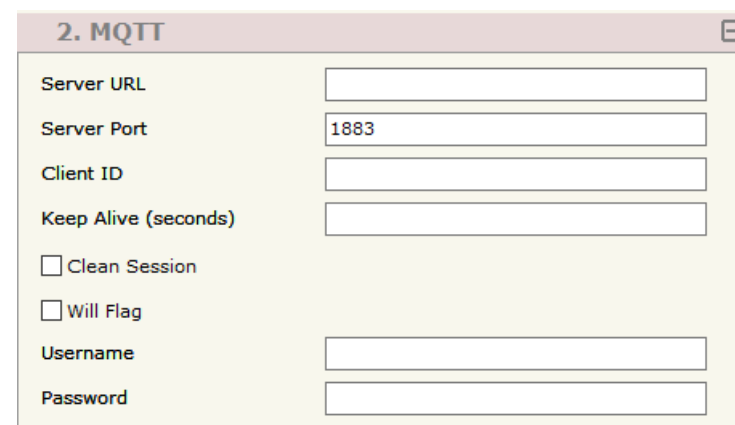

2. MQTT	
Server URL	
Server Port	1883
Client ID	
Keep Alive (seconds)	
<input type="checkbox"/> Clean Session	
<input type="checkbox"/> Will Flag	
Username	
Password	

Figure 3c: "Set Communication → MQTT" window

- In the field "**Password**" the password for the connection to the MQTT server is defined;

**ETHERNET:**

This section is used to define the main parameters of Ethernet protocol. The means of the fields are:

- In the fields "**IP Address**" the IP address for Ethernet side of the converter is defined;
- In the fields "**SubNet Mask**" the SubNet Mask for Ethernet side of the converter is defined;
- In the fields "**Gateway**" the default gateway of the net is defined. This feature can be enabled or disabled pressing the Check Box field. This feature is used for going out of the net;
- In the field "**DNS**" the DNS address is defined. This field is required if the server address is define by URL and not IP Address.

**TLS (TRANSPORT LAYER SECURITY) SERVER:**

This section is used to define the main parameters of TLS protocol. The means of the fields are:

- If the field "**Enable TLS**" is checked, the TLS protocol for secure connection is enabled;
- If the field "**Server Authentication**" is checked, the authentication of the Server using TLS is enabled.
  - If enabled, in the field "**Server Certificate**" the certificate from the Server is defined;
- If the field "**Client Authentication**" is checked, the authentication of the Client using TLS is enabled. If enabled:
  - in the field "**Client Certificate**" the certificate from the Client is defined;
  - in the field "**Client Key**" the private key of the Client is defined;
  - in the field "**Client Key Password**" the password for the private key of the Client is defined.

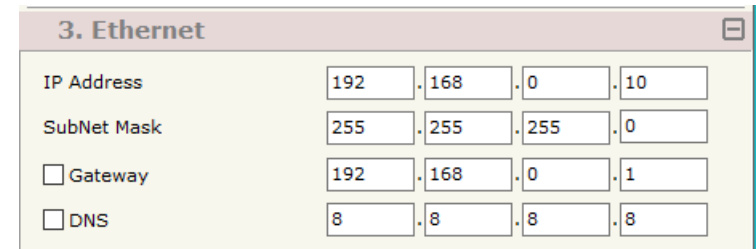

3. Ethernet				
IP Address	192	.168	.0	.10
SubNet Mask	255	.255	.255	.0
<input type="checkbox"/> Gateway	192	.168	.0	.1
<input type="checkbox"/> DNS	8	.8	.8	.8

Figure 3d: "Set Communication → Ethernet" window

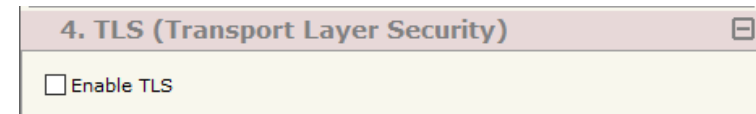

4. TLS (Transport Layer Security)
<input type="checkbox"/> Enable TLS

Figure 3e: "Set Communication → TLS" window

**NTP:**

This section is used to define the general parameters of NTP. The means of the fields are:

- In the field "**Server URL**" the URL or the IP Address of the NTP Server is defined;
- In the field "**Poll Time (seconds)**" the polling time for the time synchronization is defined.

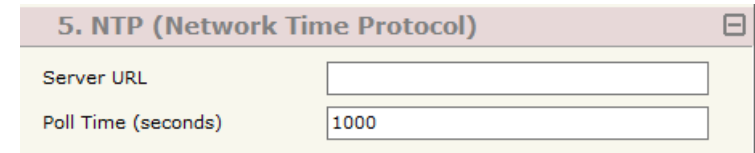

*Figure 3f: "Set Communication → NTP" window*

**WEB PAGES:**

The means of the fields for the "Web Pages" section are:

- In the field "**User**" the user name for webserver's authentication is defined;
- In the field "**Password**" the password for webserver's authentication is defined.

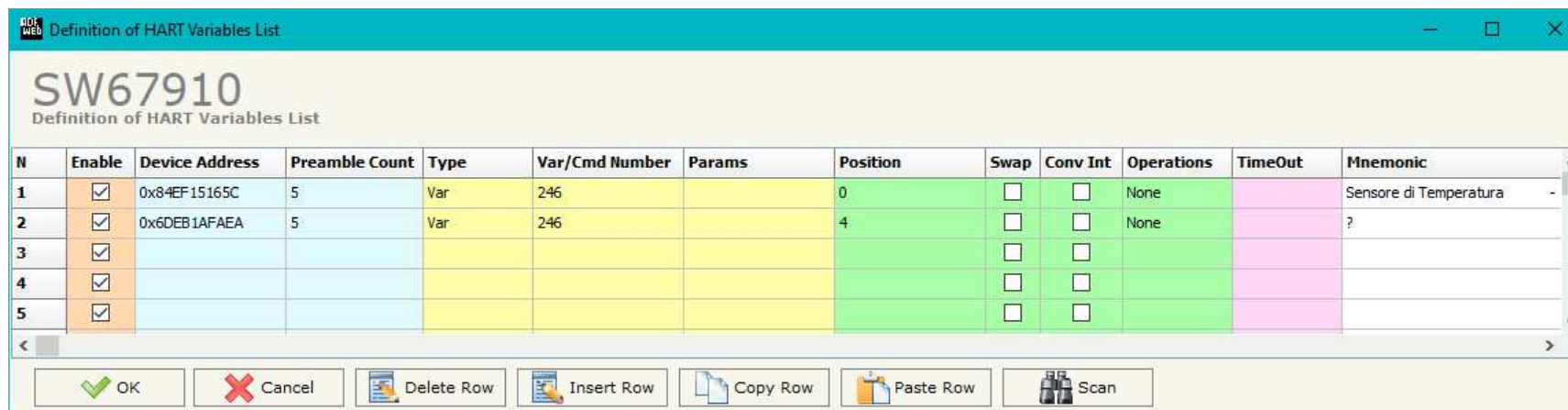

*Figure 3g: "Set Communication → Web Pages" window*

### HART VARIABLES:

By Pressing the **"HART Variables"** button from the main window for SW67910 (Fig. 2) the window "Definition of HART Variables List" appears (Fig. 4).

This section is used to define the HART variables to read/write from MQTT network.



N	Enable	Device Address	Preamble Count	Type	Var/Cmd Number	Params	Position	Swap	Conv Int	Operations	TimeOut	Mnemonic
1	<input checked="" type="checkbox"/>	0x84EF15165C	5	Var	246		0	<input type="checkbox"/>	<input type="checkbox"/>	None		Sensore di Temperatura
2	<input checked="" type="checkbox"/>	0x6DEB1AFAEA	5	Var	246		4	<input type="checkbox"/>	<input type="checkbox"/>	None		?
3	<input checked="" type="checkbox"/>							<input type="checkbox"/>	<input type="checkbox"/>			
4	<input checked="" type="checkbox"/>							<input type="checkbox"/>	<input type="checkbox"/>			
5	<input checked="" type="checkbox"/>							<input type="checkbox"/>	<input type="checkbox"/>			

Figure 4: "HART Variables" window

The means of the fields are:

- If the field **"Enable"** is checked, the HART variable is enabled;
- In the field **"Device Address"** the address of HART device is defined;
- In the field **"Preamble Count"** the number of bytes for the synchronization is defined;
- If the field **"Type"** the type of HART parameter is defined;
- In the field **"Var/Cmd Number"** the identification of variable/command to read/write is defined. From HART standard, the most used numbers are:
  - 246: Primary Variable;
  - 247: Secondary Variable;
  - 248: Tertiary Variable;
  - 249: Quaternary Variable.

- In the field "**Params**" the parameters for the commands are defined;
- In the field "**Position**" the starting byte of the internal array where mapping the HART data is defined;
- In the field "**Swap**" the bytes' order is reversed;
- In the field "**Conv Int**" the data from HART device is converted in Integer format;
- In the field "**Operations**" a post-operation on the data read is defined;
- In the field "**TimeOut**" the time for resetting the data on MQTT side is defined. If no data is not received for the timeout defined (in ms), the data on MQTT are set to 0;
- In the field "**Mnemonic**" a description of the variable is defined.

**Note:**

In order to configure the HART devices and their variables, it is possible to scan the HART network and get the data automatically. It is enough to click on "Scan" button. See page 26 for more info.

### MQTT SET TOPIC:

By Pressing the **"MQTT Set Topic"** button from the main window for SW67910 (Fig. 2) the window "Set MQTT Topics" appears (Fig. 5). This section is used to define the MQTT topics where the converter will publish the data from HART and the topic that the converter will subscribes for writing the data to HART.

### MQTT PUBLISH

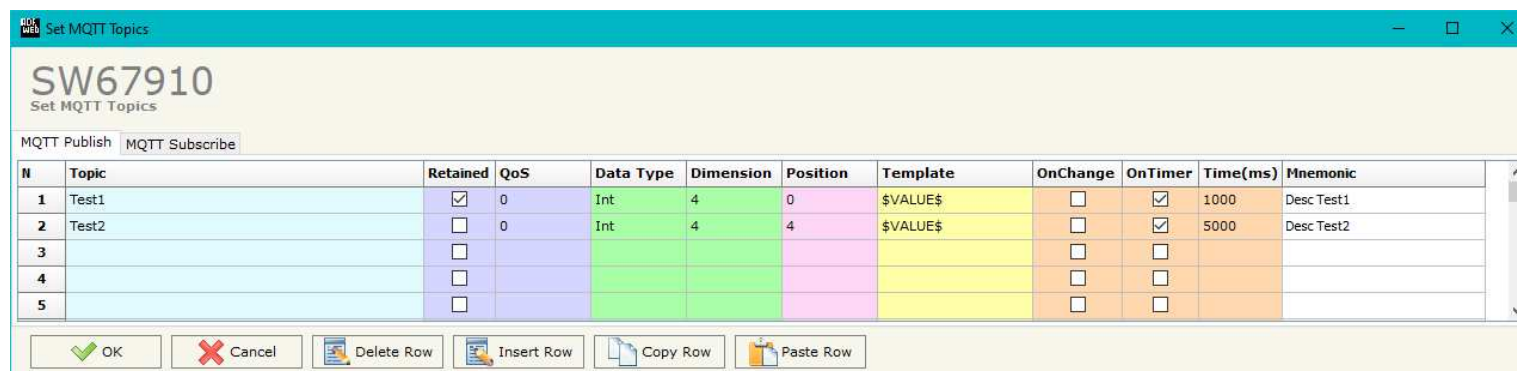

Figure 5a: "Set MQTT Topics → MQTT Publish" window

The means of the fields are:

- In the field **"Topic"** the MQTT topic is defined;
- If the field **"Retained"** is defined, the retained flag is enabled. The MQTT server will hold the last topic published;
- In the field **"QoS"** the QoS level is defined;
- In the field **"Data Type"** the type of data to use is defined;
- In the field **"Dimension"** the dimension in byte of the data is defined;
- In the field **"Position"** the starting byte of the internal memory array where taking the data is defined;
- In the field **"Template"** the structure of the MQTT payload is defined. With a double click on it, it is possible to open a window for
- If the field **"On Change"** is checked, the converter publishes the topic when the data from HART are changed;
- If the field **"OnCMD"** is checked, the converter publishes the topic when a HART message is received;
- If the field **"On Timer"** is checked, the converter publishes the topic cyclically with the delay defined in the field **"Time (ms)";**
- In the field **"Mnemonic"** a description of the topic is defined.

**MQTT SUBSCRIBE**

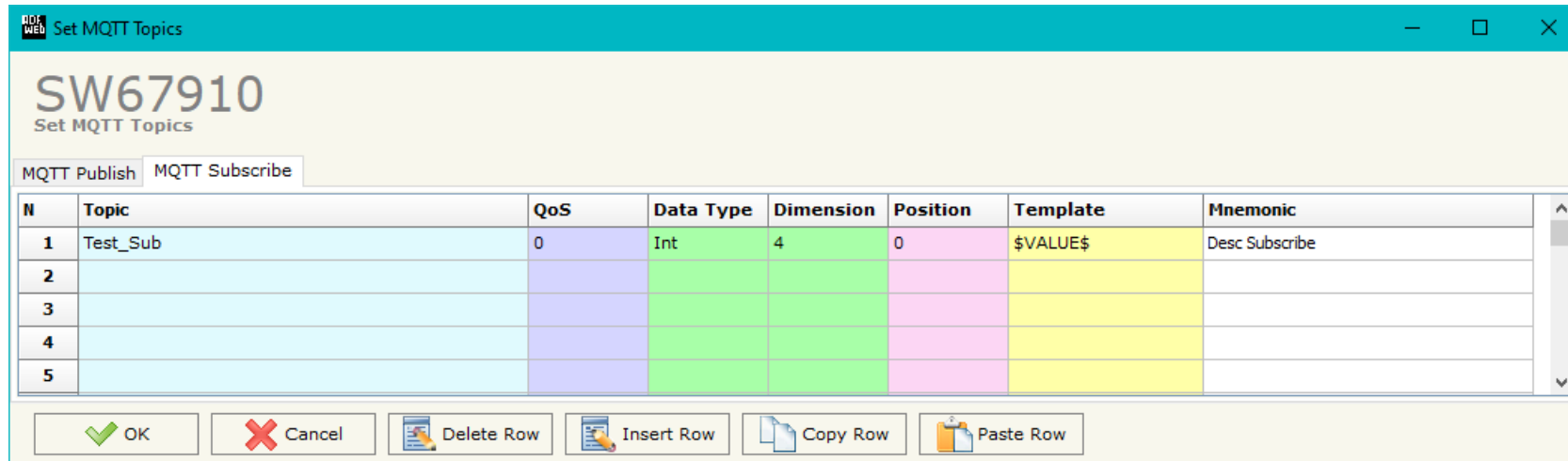

Figure 5b: "Set MQTT Topics → MQTT Subscribe" window

The means of the fields are:

- In the field "**Topic**" the MQTT topic is defined;
- In the field "**QoS**" the QoS level is defined;
- In the field "**Data Type**" the type of data to use is defined;
- In the field "**Dimension**" the dimension in byte of the data is defined;
- In the field "**Position**" the starting byte of the internal memory array where placing the data is defined;
- In the field "**Template**" the structure of the MQTT payload is defined. With a double click on it, it is possible to open a window for editing it;
- In the field "**Mnemonic**" a description of the topic is defined.

### UPDATE DEVICE:

By pressing the **“Update Device”** button, it is possible to load the created Configuration into the device; and also the Firmware, if necessary. This by using the Ethernet port.

If you don't know the actual IP address of the device you have to use this procedure:

- Turn OFF the Device;
- Put Dip2 of 'Dip-Switch A' in ON position;
- Turn ON the device
- Connect the Ethernet cable;
- Insert the IP **“192.168.2.205”**;
- Select which operations you want to do;
- Press the **“Execute update firmware”** button to start the upload;
- When all the operations are “OK” turn OFF the Device;
- Put Dip2 of 'Dip-Switch A' in OFF position;
- Turn ON the device.

If you know the actual IP address of the device, you have to use this procedure:

- Turn ON the Device with the Ethernet cable inserted;
- Insert the actual IP of the Converter;
- Select which operations you want to do;
- Press the **“Execute update firmware”** button to start the upload;
- When all the operations are “OK” the device automatically goes at Normal Mode.

At this point the configuration/firmware on the device is correctly updated.

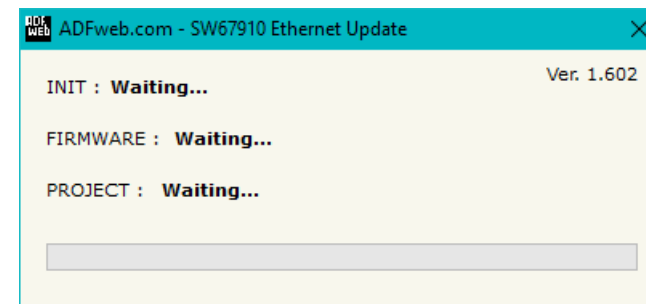
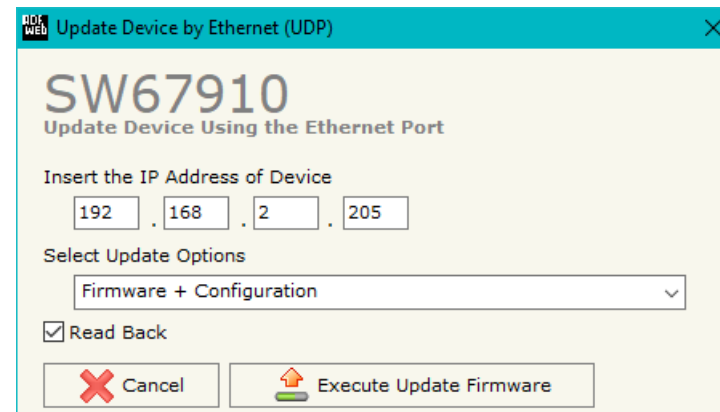

Figure 6: “Update device” windows





**Note:**

When you receive the device, for the first time, you also have to update the Firmware in the HD67910 device.



**Warning:**

If Fig. 7 appears when you try to do the Update try these points before seeking assistance:

- ➔ Try to repeat the operations for the updating;
- ➔ Try with another PC;
- ➔ Try to restart the PC;
- ➔ Check the LAN settings;
- ➔ If you are using the program inside a Virtual Machine, try to use in the main Operating System;
- ➔ If you are using Windows Seven, Vista, 8 or 10 make sure that you have the administrator privileges;
- ➔ In case you have to program more than one device, using the "UDP Update", you have to cancel the ARP table every time you connect a new device on Ethernet. For do this you have to launch the "Command Prompt" and write the command "arp -d". Pay attention that with Windows Vista, Seven, 8, 10 you have to launch the "Command Prompt" with Administrator Rights;
- ➔ Pay attention at Firewall lock.

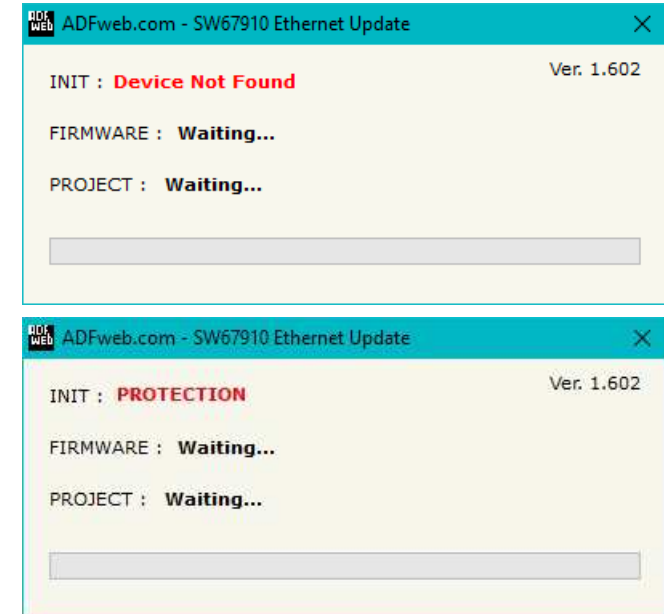

Figure 7: "Error" window



**Warning:**

In the case of HD67910 you have to use the software "SW67910": [www.adfweb.com/download/filefold/SW67910.zip](http://www.adfweb.com/download/filefold/SW67910.zip).

**SCAN FUNCTION:**

“SCAN” function is integrated in the configurator software SW67910. It is possible to access to these functions by simple click on the “Scan” button in “HART Variables” section.

It has the following characteristics:

- Possibility to scan HART network;
- Automatic decode of HART messages;
- Easy connection directly through the Ethernet port of the converter.

In order to start the Scan, it is necessary to use this procedure after having set the IP Address inside the converter:

- Connect the converter in Normal Mode to the PC using Ethernet port;
- Open the section “HART Variables” of SW67910;
- Click on “Scan” button. The window that appears will be like below:

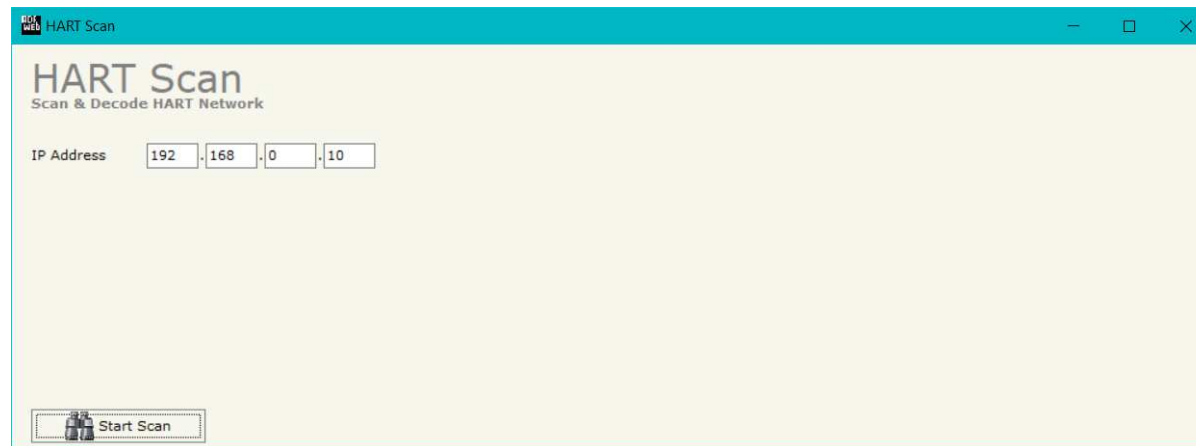

Figure 8a: “HART Scan” window

- Insert the IP Address configured in the converter;
- Start the Scan by clicking on "Start Scan" button. The window will appear like below:

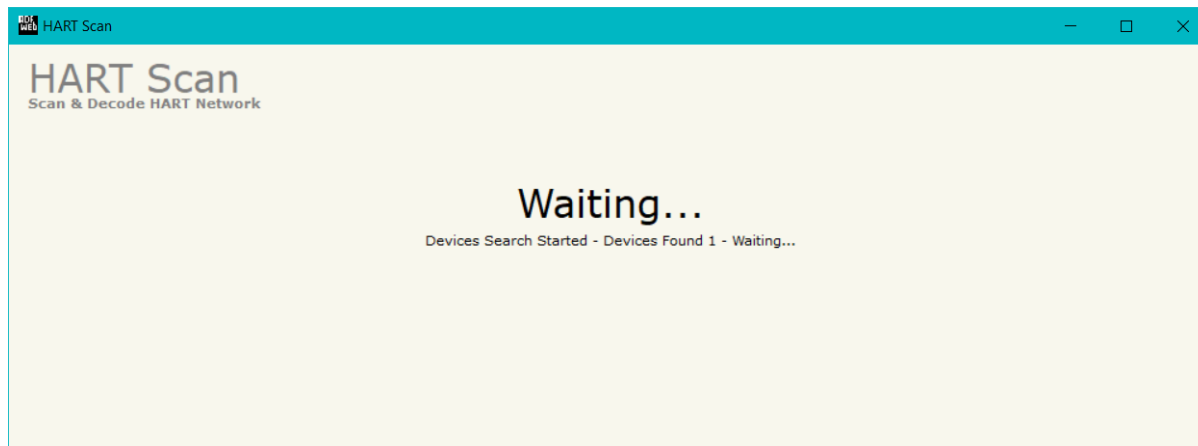

Figure 8b: "HART Scan" window

- When the Scan is complete, the software will show the results. You can import the data by clicking on "OK" button after having selected the required variables. The results will be displayed as below:

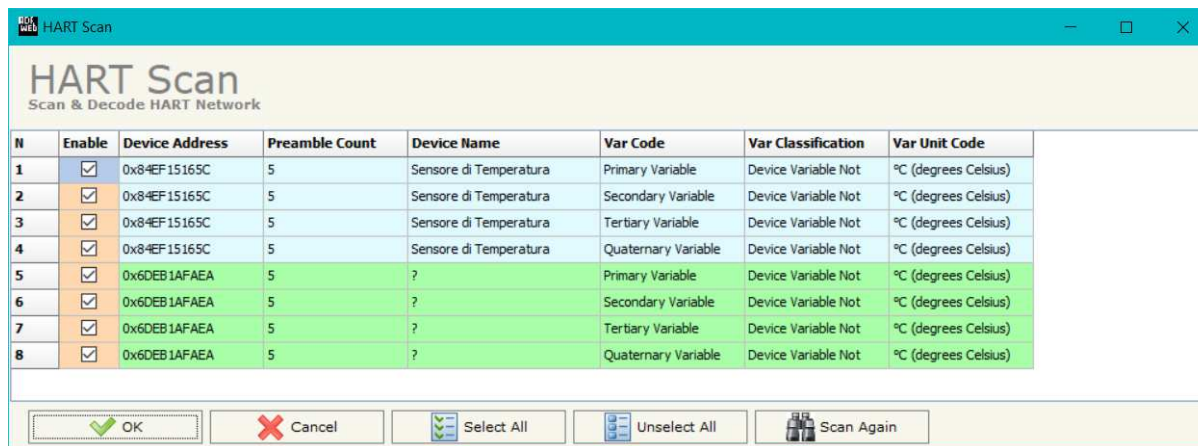

Figure 8c: "HART Scan" window

## WEBSERVER INTERFACE:

The HD67910-A1 has an integrated Webserver that allows to scan HART network, discover HART devices and program them for first installation. It is possible to use the most common browser like Internet Explorer, Google Chrome, Mozilla Firefox by editing the IP Address of the converter in the address bar of the browser.

### WELCOME



Figure 9: "Welcome" window

As soon as the connection to the Webserver interface of the Data Logger is done, "**Welcome**" window appears (Fig. 9). It has the following structure:

- "**HART Scan**" button: it is possible to go to the HART scan section where you can discover the connected HART devices;
- "**HART Control**" button: it is possible to go to the HART control section where you can program the ID and the name of the HART devices.

When one of the buttons of the “Welcome” page are pressed, it is necessary to do the login, using the “Admin” and “Password” defined in the section “Set Communication” of SW67910 (Fig. 3).

Accedi

http://192.168.2.195

La connessione a questo sito non è privata

Nome utente

Password

*Figure 10: “Login” window*

**HART SCAN**



Figure 11: "HART Scan" window

When the "HART Scan" button is pressed, the "HART Scan" window appears (Fig. 11). It has the following fields:

- "NUMBER OF DEVICES TO SEARCH FOR (Maximum 16)" field: number of Hart devices connected;
- "Scan Start" button: it is possible to start the scan of the HART network and discover the devices;
- "Read Results" button: it is possible to read the result of the last HART scan;

**HART CONTROL**

ADFweb Our converters for your connections

Hart Scan

Hart Control

### Hart Control

UNIQUE ID

POLLING  **SET NEW ADDRESS**

WRITE LONG TAG  **WRITE LONG TAG**

Figure 12: "Data Logger Commands" window

When the "HART Control" button is pressed or when a discovered HART node from HART Scan section is selected, the "**HART Control**" window appears (Fig. 13). It has the following fields:

- "**UNIQUE ID**": it is possible to insert the unique ID of the HART device to control;
- "**POLLING**": it is possible to insert the new address to assign to the HART device;
- "**WRITE LONG TAG**": it is possible to defined the description of the HART device.

## TEMPLATE STRING: DEFINITION OF MQTT PAYLOAD

In the section "MQTT Set Topic" of the SW67910, it is possible to define a Template string for the MQTT messages. The template is necessary in order to define the structure of the payload of the MQTT message and the info contained. It is possible to have a simple text format or a JSON format.

The definition of the template can be done using Key words, used to link a specific information from/to HART. The key words used and their meanings are:

- VALUE: value of the HART variable
- TIME: date and time of the MQTT message
- DESC: description of the message



### Warning:

The key words must be defined between "\$" chars in order to be recognized (Ex.: \$VALUE\$).



**MECHANICAL DIMENSIONS:**

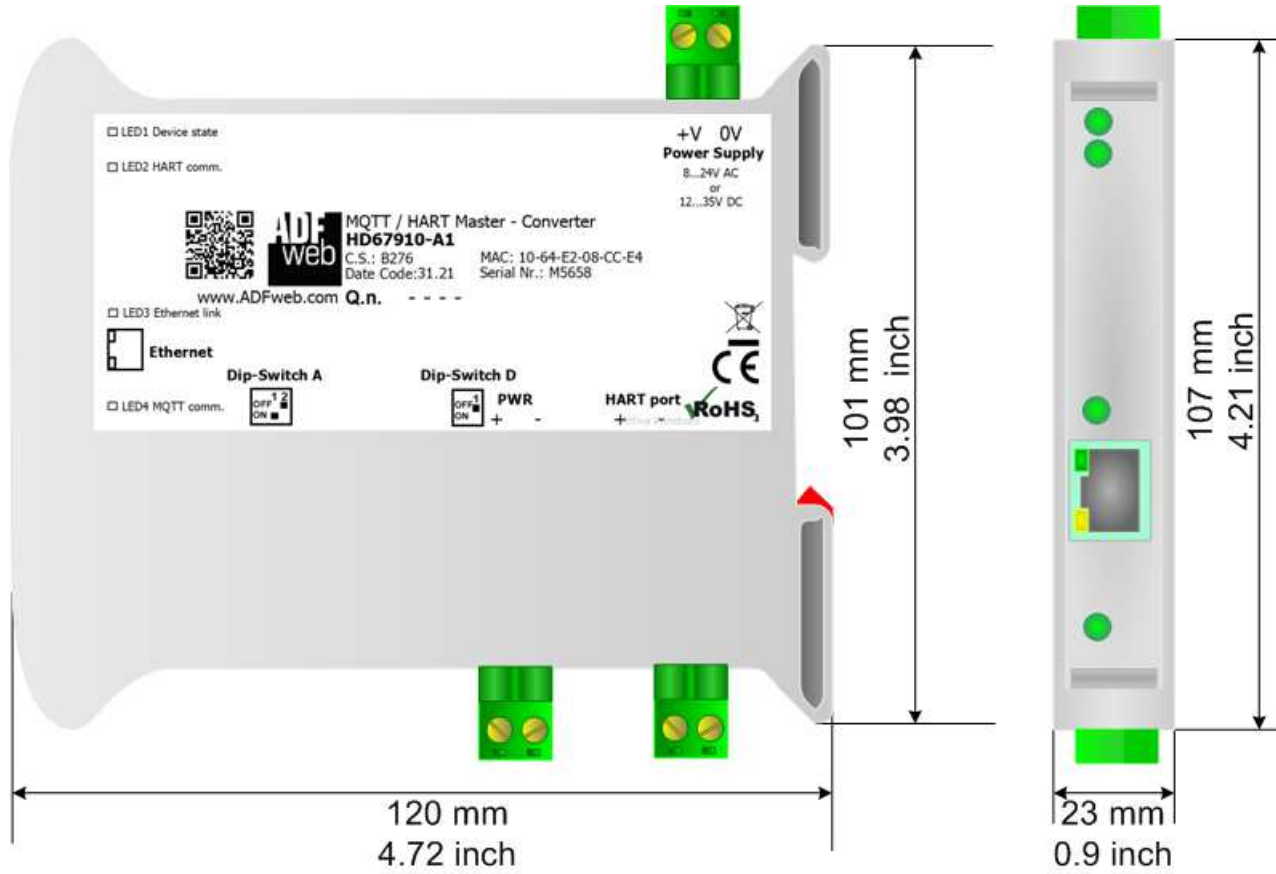

Housing: PVC  
Weight: 200g (Approx)

Figure 13: Mechanical dimensions scheme for HD67910-A1

**ORDERING INFORMATIONS:**

The ordering part number is formed by a valid combination of the following:

**HD67910 - xx**

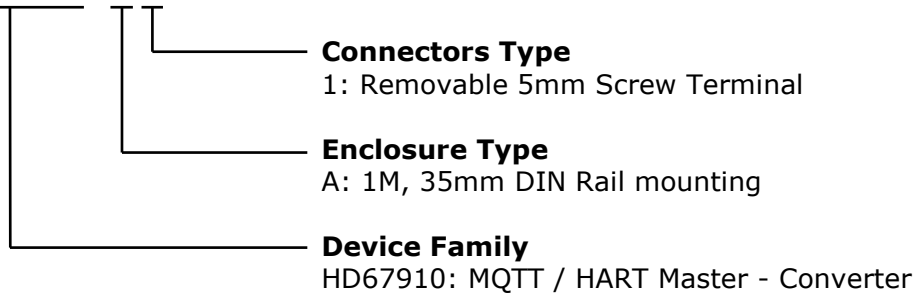

Order Code: **HD67910-A1** - MQTT / HART Master - Converter

**ACCESSORIES:**

Order Code: **AC34011** - 35mm Rail DIN - Power Supply 220/240V AC 50/60Hz – 12 V DC

Order Code: **AC34012** - 35mm Rail DIN - Power Supply 220/240V AC 50/60Hz – 24 V DC

**DISCLAIMER:**

All technical content within this document can be modified without notice. The content of the document is a under continual renewal. For losses due to fire, earthquake, third party access or other accidents, or intentional or accidental abuse, misuse, or use under abnormal conditions repairs are charged to the user. ADFweb.com S.r.l. will not be liable for accidental loss of use or inability to use this product, such as loss of business income. ADFweb.com S.r.l. shall not be liable for consequences of improper use.

**OTHER REGULATIONS AND STANDARDS:****WEEE INFORMATION**

Disposal of old electrical and electronic equipment (as in the European Union and other European countries with separate collection systems).

— This symbol on the product or on its packaging indicates that this product may not be treated as household rubbish. Instead, it should be taken to an applicable collection point for the recycling of electrical and electronic equipment. If the product is disposed correctly, you will help prevent potential negative environmental factors and impact of human health, which could otherwise be caused by inappropriate disposal. The recycling of materials will help to conserve natural resources. For more information about recycling this product, please contact your local city office, your household waste disposal service or the shop where you purchased the product.

**RESTRICTION OF HAZARDOUS SUBSTANCES DIRECTIVE**

The device respects the 2002/95/EC Directive on the restriction of the use of certain hazardous substances in electrical and electronic equipment (commonly referred to as Restriction of Hazardous Substances Directive or RoHS).

**CE MARKING**

The product conforms with the essential requirements of the applicable EC directives.

**WARRANTIES AND TECHNICAL SUPPORT:**

For fast and easy technical support for your ADFweb.com SRL products, consult our internet support at [www.adfweb.com](http://www.adfweb.com).  
Otherwise contact us at the address [support@adfweb.com](mailto:support@adfweb.com)

**RETURN POLICY:**

If while using your product you have any problem and you wish to exchange or repair it, please do the following:

- Obtain a Product Return Number (PRN) from our internet support at [www.adfweb.com](http://www.adfweb.com). Together with the request, you need to provide detailed information about the problem.
- Send the product to the address provided with the PRN, having prepaid the shipping costs (shipment costs billed to us will not be accepted).

If the product is within the warranty of twelve months, it will be repaired or exchanged and returned within three weeks. If the product is no longer under warranty, you will receive a repair estimate.



**ADFweb.com S.r.l.**  
Via Strada Nuova, 17  
IT-31010 Mareno di Piave  
TREVISO (Italy)  
Phone +39.0438.30.91.31  
Fax +39.0438.49.20.99  
[www.adfweb.com](http://www.adfweb.com)

