

User Manual

Revision 1.000
English

OPC UA Client / Modbus Slave - Converter

(Order Code: HD67B09-2-B2 , HD67B09-5-B2)

for Website information:

www.adfweb.com/?Product=HD67B09

for Price information:

www.adfweb.com/?Price=HD67B09-2-B2

www.adfweb.com/?Price=HD67B09-5-B2

Benefits and Main Features:

- ✦ Triple electrical isolation
- ✦ Power Supply 18...35V DC and 8...24 V AC
- ✦ Temperature range: -40°C/+85°C (-40°F/+185°F)



For others OPC UA Client devices, see also the following links:

OPC UA Client from/to ...

- | | |
|--|---------------------|
| www.adfweb.com?Product=HD67B08 | (Serial) |
| www.adfweb.com?Product=HD67B10 | (Modbus TCP Slave) |
| www.adfweb.com?Product=HD67B11 | (Bacnet Slave) |
| www.adfweb.com?Product=HD67B12 | (CAN) |
| www.adfweb.com?Product=HD67B13 | (CANopen) |
| www.adfweb.com?Product=HD67B14 | (DeviceNet Slave) |
| www.adfweb.com?Product=HD67B15 | (DMX) |
| www.adfweb.com?Product=HD67B16 | (EtherNet/IP Slave) |
| www.adfweb.com?Product=HD67B17 | (J1939) |
| www.adfweb.com?Product=HD67B18 | (KNX) |
| www.adfweb.com?Product=HD67B19 | (MQTT) |
| www.adfweb.com?Product=HD67B20 | (NMEA0183) |
| www.adfweb.com?Product=HD67B21 | (NMEA2000) |
| www.adfweb.com?Product=HD67B22 | (PROFINET) |
| www.adfweb.com?Product=HD67B23 | (SNMP Agent) |

Do you have an your customer protocol?

See the following links:

www.adfweb.com?Product=HD67003

Do you need to choose a device? do you want help?

Ask it to the following link:

www.adfweb.com?Cmd=helpme



User Manual

INDEX:

	Page
INDEX	2
UPDATED DOCUMENTATION	2
REVISION LIST	2
WARNING	2
TRADEMARKS	2
SECURITY ALERT	3
EXAMPLE OF CONNECTION	4
CONNECTION SCHEME	5
CHARACTERISTICS	7
CONFIGURATION	7
POWER SUPPLY	8
FUNCTION MODES	9
LEDS	10
RS232	11
RS485	12
ETHERNET	13
USE OF COMPOSITOR SW67B09	14
NEW CONFIGURATION / OPEN CONFIGURATION	15
SOFTWARE OPTIONS	16
SET COMMUNICATION	18
OPC UA ACCESS	20
UPDATE DEVICE	26
MODBUS MAP	28
MECHANICAL DIMENSIONS	30
ORDERING INFORMATIONS	31
ACCESSORIES	31
DISCLAIMER	32
OTHER REGULATIONS AND STANDARDS	32
WARRANTIES AND TECHNICAL SUPPORT	33
RETURN POLICY	33

UPDATED DOCUMENTATION:

Dear customer, we thank you for your attention and we remind you that you need to check that the following document is:

- ✚ Updated
- ✚ Related to the product you own

To obtain the most recently updated document, note the “document code” that appears at the top right-hand corner of each page of this document.

With this “Document Code” go to web page www.adfweb.com/download/ and search for the corresponding code on the page. Click on the proper “Document Code” and download the updates.

REVISION LIST:

Revision	Date	Author	Chapter	Description
1.000	13/03/2019	Tf	All	First release version

WARNING:

ADFweb.com reserves the right to change information in this manual about our product without warning.
ADFweb.com is not responsible for any error this manual may contain.

TRADEMARKS:

All trademarks mentioned in this document belong to their respective owners.

SECURITY ALERT:**GENERAL INFORMATION**

To ensure safe operation, the device must be operated according to the instructions in the manual. When using the device, legal and safety regulation are required for each individual application. The same applies also when using accessories.

INTENDED USE

Machines and systems must be designed so the faulty conditions do not lead to a dangerous situation for the operator (i.e. independent limit switches, mechanical interlocks, etc.).

QUALIFIED PERSONNEL

The device can be used only by qualified personnel, strictly in accordance with the specifications.

Qualified personnel are persons who are familiar with the installation, assembly, commissioning and operation of this equipment and who have appropriate qualifications for their job.

RESIDUAL RISKS

The device is state-of-the-art and is safe. The instruments can represent a potential hazard if they are inappropriately installed and operated by untrained personnel. These instructions refer to residual risks with the following symbol:



This symbol indicates that non-observance of the safety instructions is a danger for people that could lead to serious injury or death and / or the possibility of damage.

CE CONFORMITY

The declaration is made by our company. You can send an email to support@adfweb.com or give us a call if you need it.

EXAMPLE OF CONNECTION:

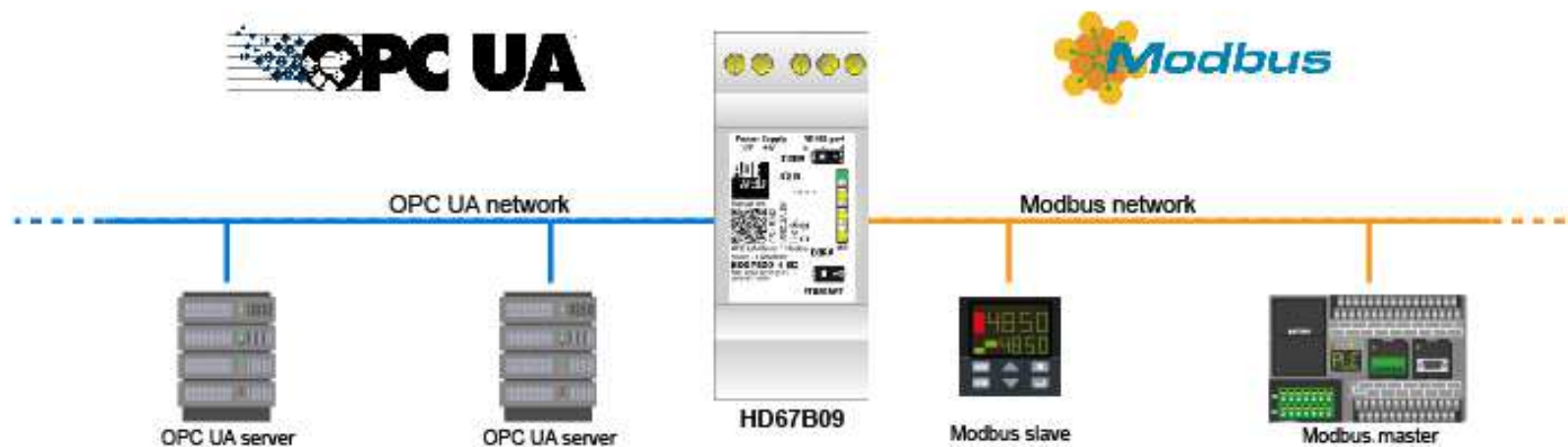

ADFweb.com srl
 Tel. +39 0438 309 131 - Fax +39 0438 492 099
 info@adfweb-com - www.adfweb.com

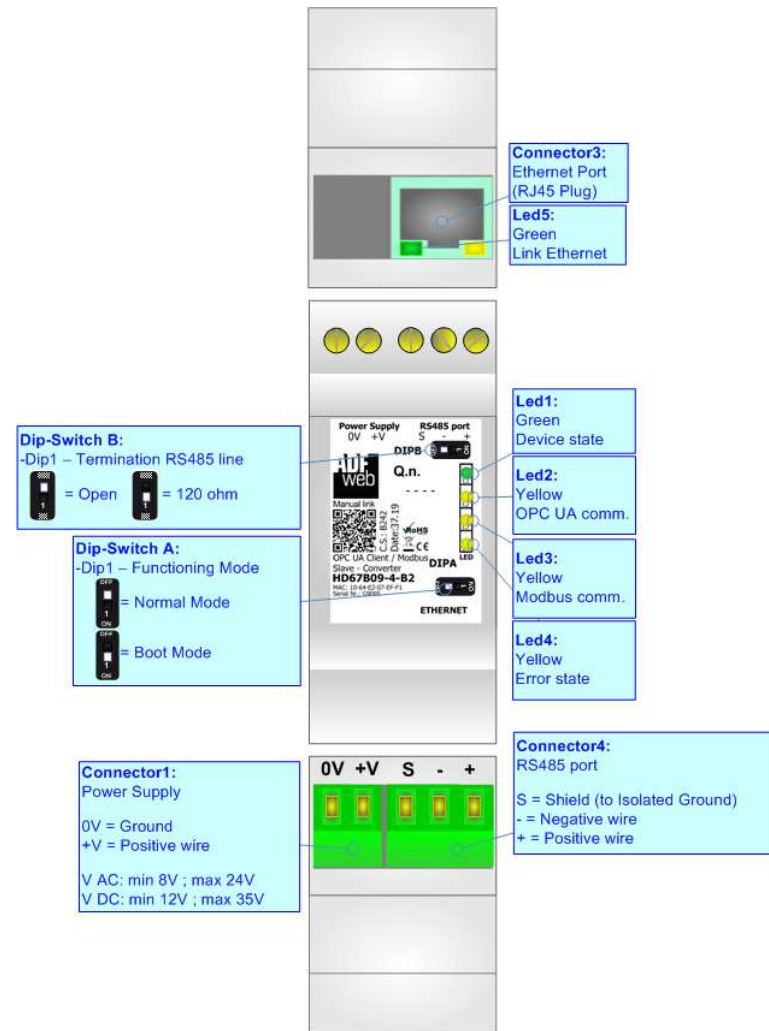

Figure 1b: Connection scheme for HD67B09-5-B2

CHARACTERISTICS:

The HD67B09-B2 is a OPC UA Client / Modbus Slave converter.

It allows the following characteristics:

- Up to 1500 bytes in reading and 1500 bytes in writing;
- Two-directional information between Modbus bus and OPC UA bus;
- Mountable on 35mm Rail DIN;
- Wide power supply input range: 8...24V AC or 12...35V DC;
- Wide temperature range: -40°C / 85°C [-40°F / +185°F].

CONFIGURATION:

You need Compositor SW67B09 software on your PC in order to perform the following:

- Define the parameter of OPC UA line;
- Define the parameter of Modbus line;
- Update the device.

POWER SUPPLY:

The devices can be powered between a wide range of tensions. For more details see the two tables below.

	VAC		VDC	
	Vmin	Vmax	Vmin	Vmax
HD67B09-B2	8V	24V	12V	35V

Consumption at 24V DC:

Device	W/VA
HD67B09-B2	4



Caution: Not reverse the polarity power

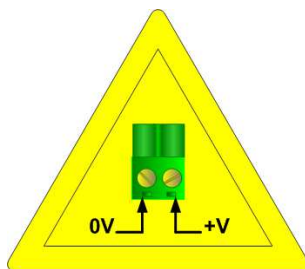

HD67B09-B2



Connector1:
Power Supply
0V = Ground
+V = Positive wire
V AC: min 8V ; max 24V
V DC: min 12V ; max 35V

FUNCTION MODES:

The device has got two functions mode depending of the position of the Dip1 of 'Dip-Switch A':

- The first, with Dip1 in Off position (factory setting), is used for the normal working of the device.
- The second, with Dip1 in On position, is used for upload the Project/Firmware.

For the operations to follow for the updating (see 'UPDATE DEVICE' section).

According to the functioning mode, the LEDs will have specifics functions (see 'LEDS' section).

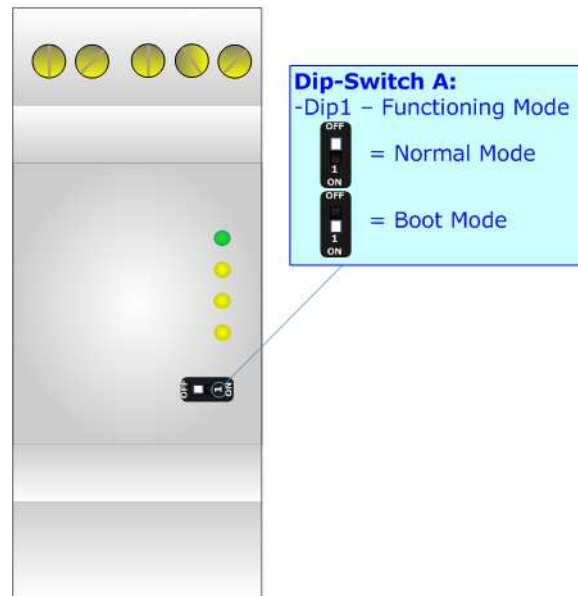

LEDS:

The device has got six LEDs that are used to give information of the functioning status. The various meanings of the LEDs are described in the table below.

LED	Normal Mode	Boot Mode
1: Device State (green)	Blinks slowly (~1Hz)	Blinks quickly: Boot state Blinks very slowly (~0.5Hz): update in progress
2: OPC UA comm. (yellow)	Flashing: OPC UA request OFF: No OPC UA request	Blinks quickly: Boot state Blinks very slowly (~0.5Hz): update in progress
3: Modbus comm. (yellow)	Flashing: Modbus response OFF: No Modbus response	Blinks quickly: Boot state Blinks very slowly (~0.5Hz): update in progress
4: Error state (yellow)	ON: An error has occurred OFF: The device is correctly running	Blinks quickly: Boot state Blinks very slowly (~0.5Hz): update in progress
5: Link Ethernet (green)	ON: Ethernet cable connected OFF: Ethernet cable disconnected	ON: Ethernet cable connected OFF: Ethernet cable disconnected

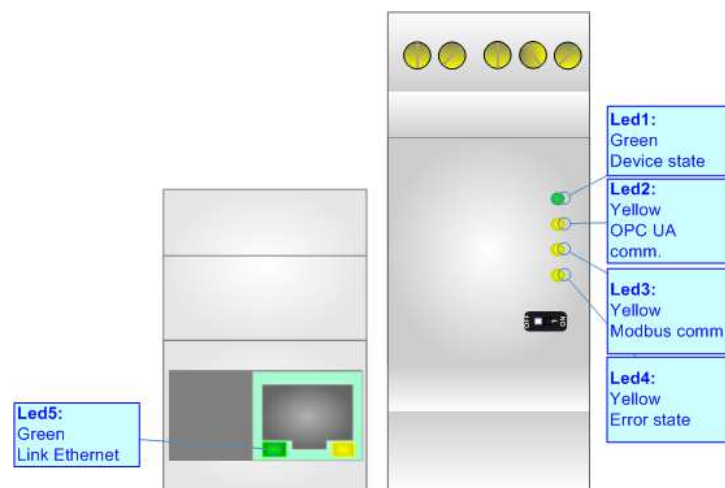

RS232:

The connection from RS232 socket to a serial port (example one from a personal computer) must be made with a Null Modem cable (a serial cable where the pins 2 and 3 are crossed). It is recommended that the RS232 cable not exceed 15 meters.

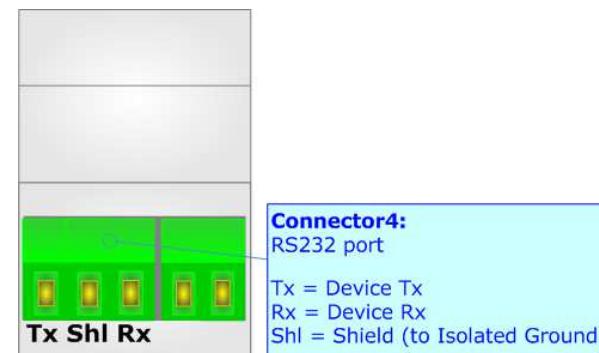

RS485:

For terminate the RS485 line with a 120Ω resistor it is necessary to put ON dip 1, like in figure.

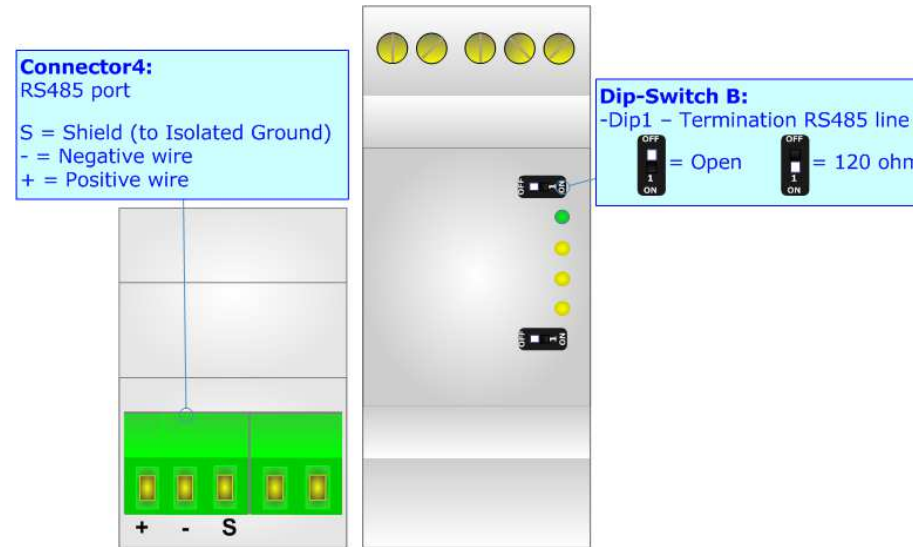

The maximum length of the cable should be 1200m (4000 feet).

Here some codes of cables:

- Belden: p/n 8132 - 2x 28AWG stranded twisted pairs conductor + foil shield + braid shield;
- Belden p/n 82842 - 2x 24AWG stranded twisted pairs conductor + foil shield + braid shield;
- Tasker: p/n C521 - 1x 24AWG twisted pair conductor + foil shield + braid shield;
- Tasker: p/n C522 - 2x 24AWG twisted pairs conductor + foil shield + braid shield.

ETHERNET:

The Ethernet connection must be made using Connector3 of HD67B09-x-B2 with at least a Category 5E cable. The maximum length of the cable should not exceed 100m. The cable has to conform to the T568 norms relative to connections in cat.5 up to 100 Mbps. To connect the device to an Hub/Switch is recommended the use of a straight cable, to connect the device to a PC/PLC/other is recommended the use of a cross cable.



USE OF COMPOSITOR SW67B09:

To configure the Converter, use the available software that runs with Windows called SW67B09. It is downloadable on the site www.adfweb.com and its operation is described in this document. *(This manual is referenced to the last version of the software present on our web site)*. The software works with MSWindows (XP, Vista, Seven, 8, 10; 32/64bit).

When launching the SW67B09, the window below appears (Fig. 2).

 **Note:**
It is necessary to have installed .Net Framework 4.



Figure 2: Main window for SW67B09

NEW CONFIGURATION / OPEN CONFIGURATION:

The “**New Configuration**” button creates the folder which contains the entire device’s configuration.



A device’s configuration can also be imported or exported:

- To clone the configurations of a programmable “OPC UA Client / Modbus Slave - Converter” in order to configure another device in the same manner, it is necessary to maintain the folder and all its contents;
- To clone a project in order to obtain a different version of the project, it is sufficient to duplicate the project folder with another name and open the new folder with the button “**Open Configuration**”.

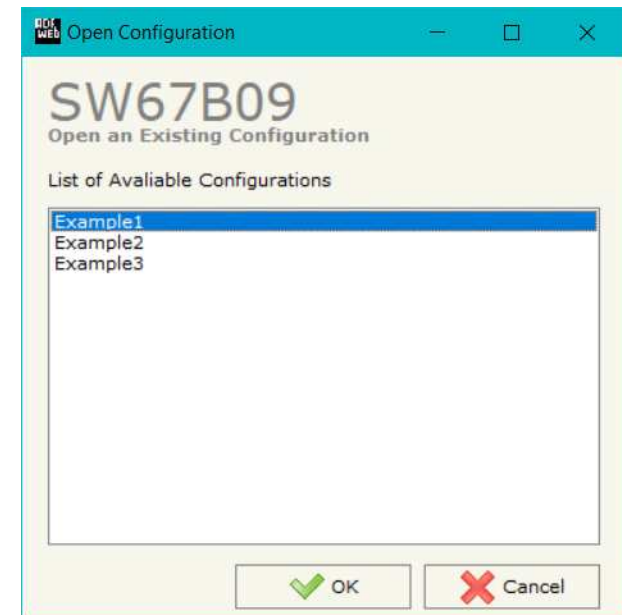

SOFTWARE OPTIONS:

By pressing the “**Settings**” () button there is the possibility to change the language of the software and check the updatings for the compositor.

In the section “Language” it is possible to change the language of the software.

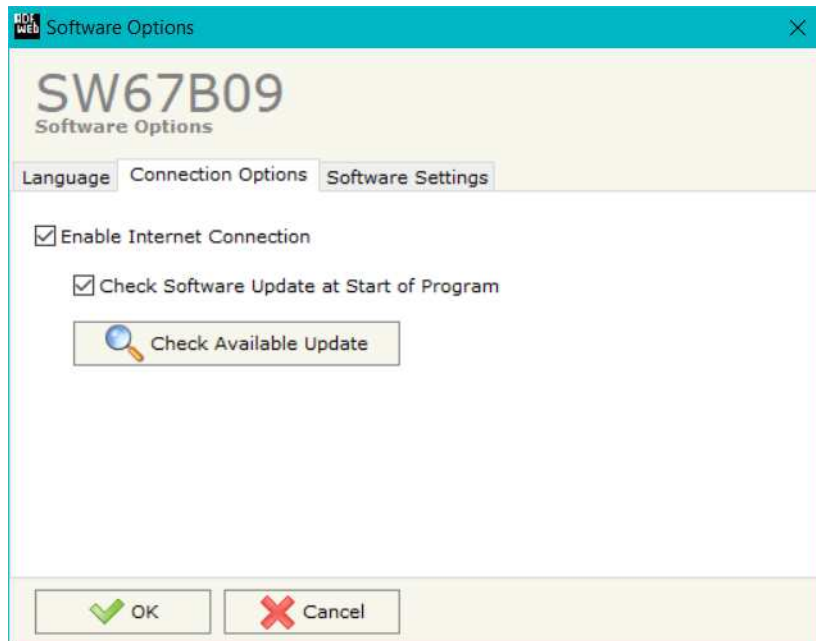

In the section “Connection Options”, it is possible to check if there are some updatings of the software compositor in ADFweb.com website. Checking the option “**Check Software Update at Start of Program**”, the SW67B09 check automatically if there are updatings when it is launched.

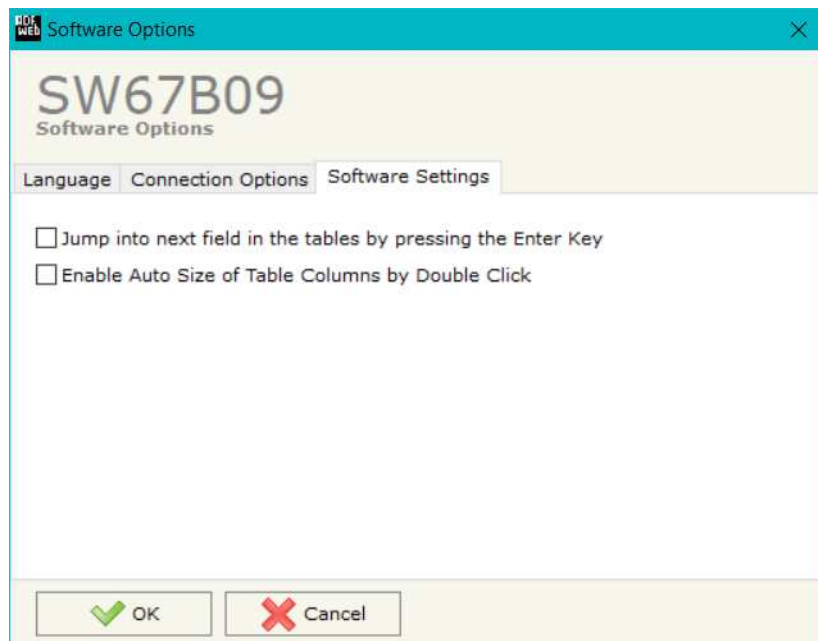

In the section "Software Settings", it is possible to enable/disable some keyboard's commands for an easier navigation inside the tables contained in the different sections of the software.

SET COMMUNICATION:

This section define the fundamental communication parameters of two buses, OPC UA and Modbus.

By Pressing the **"Set Communication"** button from the main window for SW67B09 (Fig. 2) the window "Set Communication" appears (Fig. 3).

The means of the fields for "OPC UA Client" are:

- In the field **"IP Address"** the IP address for OPC UA side of the converter is defined;
- In the field **"SubNet Mask"** the SubNet Mask for OPC UA side of the converter is defined;
- In the field **"Gateway"** the default gateway of the net is defined. This feature can be enabled or disabled pressing the Check Box field. This feature is used for going out of the net;
- In the field **"DNS"** the IP Address of the DNS server is defined. This feature can be enabled or disabled pressing the Check Box field.

The means of the fields for "Modbus Slave" are:

- In the field **"Serial"** the serial lien to use for Modbus communication is defined;
- In the field **"Baudrate"** the baudrate for the serial line is defined;
- In the field **"Parity"** the parity of the serial line is defined;
- In the field **"Stop Bits"** the number of Stop Bits is defined;
- In the field **"ID Device"** the address of serial Modbus device is defined;
- If the field **"Read with Input Register / Status Function"** is checked, it is possible to read the Input bytes of OPC UA side with Input Registers (Function 04) and write the Output bytes of OPC UA side with Holding Registers (Function 06/16). The Output bytes are readable with Function 03. Otherwise, only Holding Registers will be used and the Output bytes of OPC UA side cannot be read back.

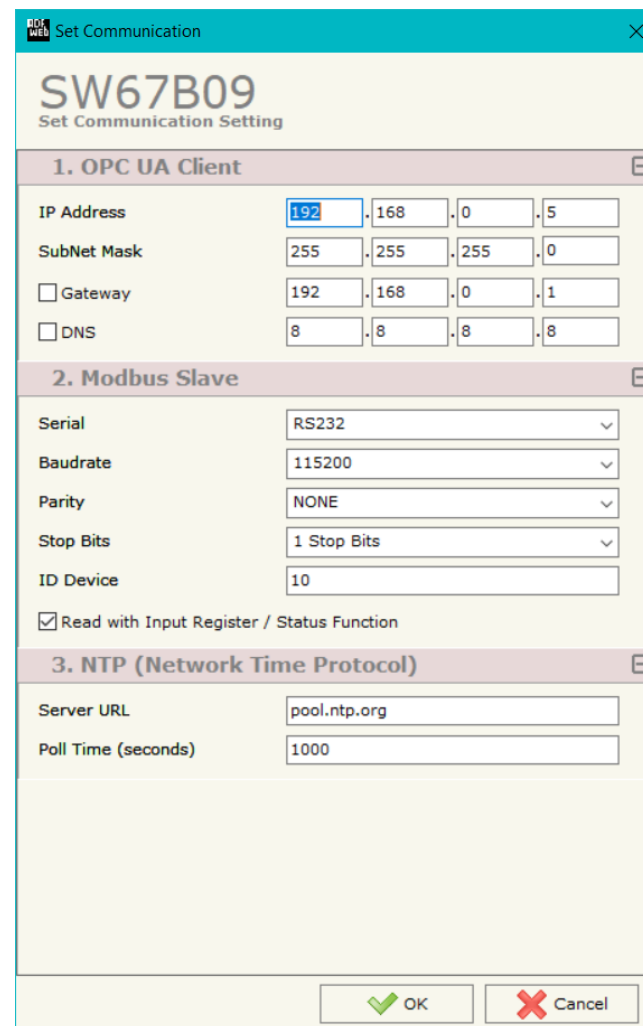

Figure 3: "Set Communication" window

The means of the fields for "NTP (Network Time Protocol)" are:

- In the field "**Server URL**" the URL or the IP Address of the NTP Server is defined;
- In the field "**Poll Time (seconds)**" the polling time for the time synchronization is defined.

OPC UA ACCESS:

By Pressing the "OPC UA Client Access" button from the main window for SW67B09 (Fig. 2) the window "OPC UA Client Access" appears (Fig. 4).

This section is used to define the list of the OPC UA Servers to read/write with the OPC UA Client.

SW67B09
OPC UA Client Access

OPC UA Server List

N	Enable	Server Address	Authorization	User	Password	Certificate	Private Key	Security Type	Security Policy	Mnemonic
1	<input checked="" type="checkbox"/>	opc.tcp://192.168.2.58:4840	Anonymous					None	None	
2	<input checked="" type="checkbox"/>	opc.tcp://192.168.2.184:4840	Username and	root	root			None	None	a1

Add
 Modify
 Delete
 Scan

OPC UA Variables List

Variables in Read Variables in Write

N	Enable	Display Name	Node Type	Node ID	Var Type	Name Space Index	Time (ms)	Position	Mnemonic
1	<input checked="" type="checkbox"/>	Temperature	String	_System.General.T	Float	3	1000	0	a1
2	<input checked="" type="checkbox"/>	R_Byte_68	String	S7.Tabella delle	UInt8	2	1200	4	a2
3	<input checked="" type="checkbox"/>								
4	<input checked="" type="checkbox"/>								
5	<input checked="" type="checkbox"/>								
6	<input checked="" type="checkbox"/>								
7	<input checked="" type="checkbox"/>								
8	<input checked="" type="checkbox"/>								
9	<input checked="" type="checkbox"/>								
10	<input checked="" type="checkbox"/>								
11	<input checked="" type="checkbox"/>								
12	<input checked="" type="checkbox"/>								

OK
 Cancel
 Delete Row
 Insert Row
 Copy Row
 Paste Row
 Auto Pos

Figure 4: "OPC UA Client Access" window

By clicking on **"Add"**, it is possible to add a new OPC UA Server inserting its characteristics (Server Address, Authorization, Security Type...). The window "Add OPC UA Server" appears (Fig. 5). By clicking on **"Modify"**, it is possible to change these characteristics for the selected Server. The window "Modify OPC UA Server" appears (Fig. 6).



Figure 5: "Add OPC UA Server"

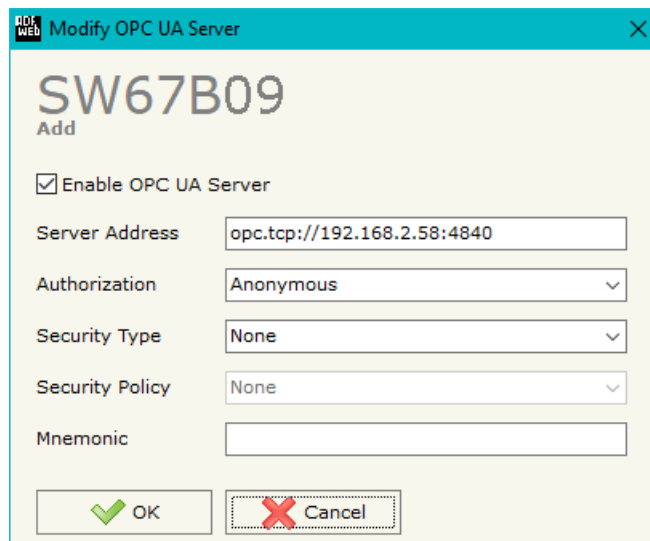
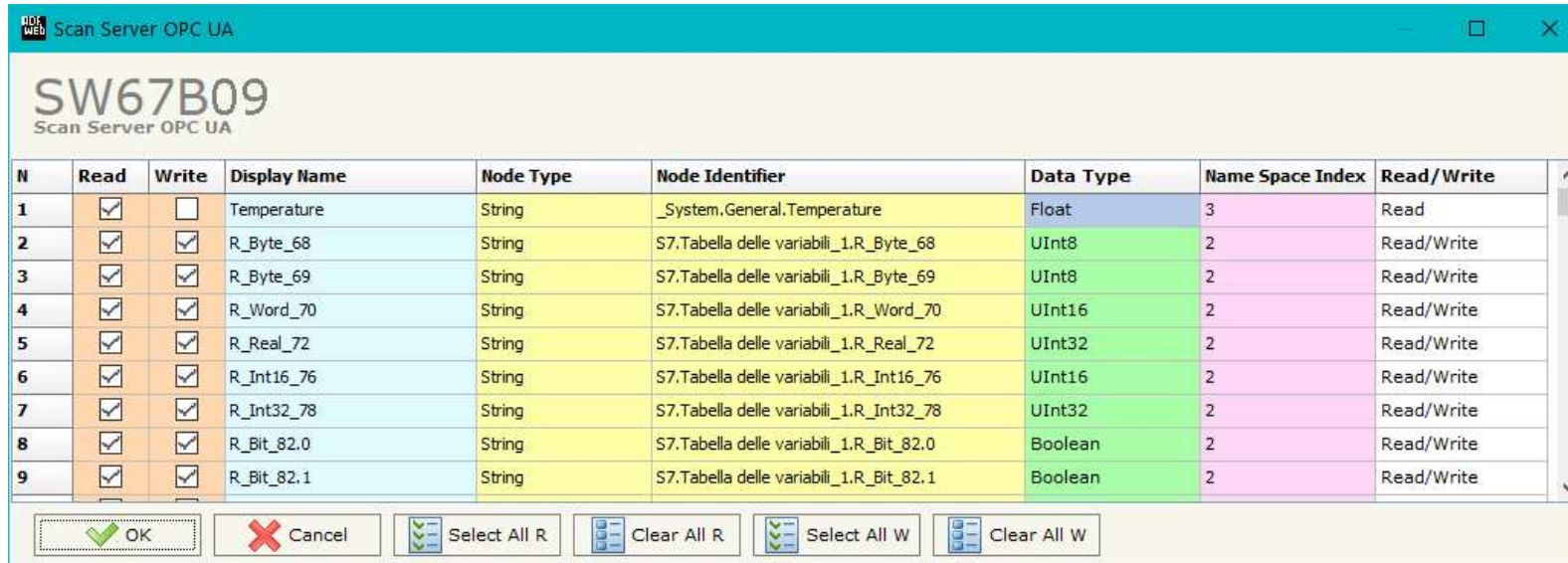

Figure 6: "Modify OPC UA Server"

By clicking on “**Scan**”, it is possible to get the list of available variables from the selected Server. The window “Scan Server OPC UA” appears (Fig. 7).



N	Read	Write	Display Name	Node Type	Node Identifier	Data Type	Name Space Index	Read/Write
1	<input checked="" type="checkbox"/>	<input type="checkbox"/>	Temperature	String	_System.General.Temperature	Float	3	Read
2	<input checked="" type="checkbox"/>	<input checked="" type="checkbox"/>	R_Byte_68	String	S7.Tabella delle variabili_1.R_Byte_68	UInt8	2	Read/Write
3	<input checked="" type="checkbox"/>	<input checked="" type="checkbox"/>	R_Byte_69	String	S7.Tabella delle variabili_1.R_Byte_69	UInt8	2	Read/Write
4	<input checked="" type="checkbox"/>	<input checked="" type="checkbox"/>	R_Word_70	String	S7.Tabella delle variabili_1.R_Word_70	UInt16	2	Read/Write
5	<input checked="" type="checkbox"/>	<input checked="" type="checkbox"/>	R_Real_72	String	S7.Tabella delle variabili_1.R_Real_72	UInt32	2	Read/Write
6	<input checked="" type="checkbox"/>	<input checked="" type="checkbox"/>	R_Int16_76	String	S7.Tabella delle variabili_1.R_Int16_76	UInt16	2	Read/Write
7	<input checked="" type="checkbox"/>	<input checked="" type="checkbox"/>	R_Int32_78	String	S7.Tabella delle variabili_1.R_Int32_78	UInt32	2	Read/Write
8	<input checked="" type="checkbox"/>	<input checked="" type="checkbox"/>	R_Bit_82.0	String	S7.Tabella delle variabili_1.R_Bit_82.0	Boolean	2	Read/Write
9	<input checked="" type="checkbox"/>	<input checked="" type="checkbox"/>	R_Bit_82.1	String	S7.Tabella delle variabili_1.R_Bit_82.1	Boolean	2	Read/Write

Figure 7: “Scan Server OPC UA” window

The means of the checkboxes inside the table are:

- If the field “**Read**” is checked, the variable can be read;
- If the field “**Write**” is checked, the variable can be written.



Note:

For each variable, it is possible to uncheck these fields and the variable will not be used in read/write.

After the scan, the selected variables will appear in “Variables in Read” and/or “Variables in Write” sections, in the lower part of the window “OPC UA Client Access” (Fig. 4).

The “Variables in Read” section is used to define the OPC UA variables to read on Modbus side (Fig. 8).

OPC UA Variables List									
Variables in Read Variables in Write									
N	Enable	Display Name	Node Type	Node ID	Var Type	Name Space Index	Time (ms)	Position	Mnemonic
1	<input checked="" type="checkbox"/>	Temperature	String	_System.General.T	Float	3	1000	0	
2	<input checked="" type="checkbox"/>	R_Byte_68	String	S7.Tabella delle	UInt8	2	2000	4	
3	<input checked="" type="checkbox"/>	R_Byte_69	String	S7.Tabella delle	UInt8	2	2000	5	
4	<input checked="" type="checkbox"/>	R_Word_70	String	S7.Tabella delle	UInt16	2	2000	6	
5	<input checked="" type="checkbox"/>	R_Real_72	String	S7.Tabella delle	UInt32	2	2000	8	
6	<input checked="" type="checkbox"/>	R_Int16_76	String	S7.Tabella delle	UInt16	2	2000	12	
7	<input checked="" type="checkbox"/>	R_Int32_78	String	S7.Tabella delle	UInt32	2	2000	14	
8	<input checked="" type="checkbox"/>	R_Bit_82.0	String	S7.Tabella delle	Boolean	2	2000	18	
9	<input checked="" type="checkbox"/>	R_Bit_82.1	String	S7.Tabella delle	Boolean	2	2000	19	
10	<input checked="" type="checkbox"/>	R_Bit_82.2	String	S7.Tabella delle	Boolean	2	2000	20	
11	<input checked="" type="checkbox"/>	R_Bit_82.3	String	S7.Tabella delle	Boolean	2	2000	21	

Figure 8: “Variables in Read” section

The means of the fields are:

- If the field “**Enable**” is checked, the OPC UA variable is enabled;
- In the field “**Display name**” the name of the OPC UA variable is defined;
- In the field “**Node Type**” the type of the OPC UA node, which includes the variable, is defined;
- In the field “**Node ID**” the name of the OPC UA node, which includes the variable, is defined;
- In the field “**Var Type**” the data format of the OPC UA variable is defined;
- In the field “**Name Space Index**” the Name Space Index of the node, which includes the variable, is defined;
- In the field “**Time (ms)**” the delay in ms between two readings of the variable is defined;
- In the field “**Position**” the starting byte of the internal memory array where saving the value is defined;
- In the field “**Mnemonic**” a description of the variable is defined.

The “Variables in Write” section is used to define the OPC UA variables to write from Modbus side (Fig. 9).

OPC UA Variables List												
Variables in Read												Variables in Write
N	Enable	Display Name	Node Type	Node ID	Var Type	Name Space Index	On Change	On CMD	On Timer	Time (ms)	Position	Mnemonic
1	<input checked="" type="checkbox"/>	R_Byte_68	String	S7.Tabella delle	UInt8	2	<input checked="" type="checkbox"/>	<input type="checkbox"/>	<input type="checkbox"/>	0	0	
2	<input checked="" type="checkbox"/>	R_Byte_69	String	S7.Tabella delle	UInt8	2	<input checked="" type="checkbox"/>	<input type="checkbox"/>	<input type="checkbox"/>	0	1	
3	<input checked="" type="checkbox"/>	R_Word_70	String	S7.Tabella delle	UInt16	2	<input checked="" type="checkbox"/>	<input type="checkbox"/>	<input type="checkbox"/>	0	2	
4	<input checked="" type="checkbox"/>	R_Real_72	String	S7.Tabella delle	UInt32	2	<input checked="" type="checkbox"/>	<input type="checkbox"/>	<input type="checkbox"/>	0	4	
5	<input checked="" type="checkbox"/>	R_Int16_76	String	S7.Tabella delle	UInt16	2	<input checked="" type="checkbox"/>	<input type="checkbox"/>	<input type="checkbox"/>	0	8	
6	<input checked="" type="checkbox"/>	R_Int32_78	String	S7.Tabella delle	UInt32	2	<input checked="" type="checkbox"/>	<input type="checkbox"/>	<input type="checkbox"/>	0	10	
7	<input checked="" type="checkbox"/>	R_Bit_82.0	String	S7.Tabella delle	Boolean	2	<input checked="" type="checkbox"/>	<input type="checkbox"/>	<input type="checkbox"/>	0	14	
8	<input checked="" type="checkbox"/>	R_Bit_82.1	String	S7.Tabella delle	Boolean	2	<input checked="" type="checkbox"/>	<input type="checkbox"/>	<input type="checkbox"/>	0	15	
9	<input checked="" type="checkbox"/>	R_Bit_82.2	String	S7.Tabella delle	Boolean	2	<input checked="" type="checkbox"/>	<input type="checkbox"/>	<input type="checkbox"/>	0	16	
10	<input checked="" type="checkbox"/>	R_Bit_82.3	String	S7.Tabella delle	Boolean	2	<input checked="" type="checkbox"/>	<input type="checkbox"/>	<input type="checkbox"/>	0	17	
11	<input checked="" type="checkbox"/>	R_Bit_82.4	String	S7.Tabella delle	Boolean	2	<input checked="" type="checkbox"/>	<input type="checkbox"/>	<input type="checkbox"/>	0	18	

Figure 9: “Variables in Write” section

In “Variables in Write” section (Fig. 8), the means of the fields are:

- If the field “**Enable**” is checked, the OPC UA variable is enabled;
- In the field “**Display name**” the name of the OPC UA variable is defined;
- In the field “**Node Type**” the type of the OPC UA node, which includes the variable, is defined;
- In the field “**Node ID**” the name of the OPC UA node, which includes the variable, is defined;
- In the field “**Var Type**” the data format of the OPC UA variable is defined;
- In the field “**Name Space Index**” the Name Space Index of the node, which includes the variable, is defined;
- If the field “**On Change**” is checked, the OPC UA variable is sent when the data on Modbus changes the value;
- If the field “**On CMD**” is checked, the OPC UA variable is sent when a Modbus request is received;
- If the field “**On Timer**” is checked, the OPC UA variable is sent cyclically;
- In the field “**Time (ms)**” the delay in ms between two writings of the variable is defined (if “On Timer” is checked);

- In the field "**Position**" the starting byte of the internal memory array where getting the value is defined;
- In the field "**Mnemonic**" a description of the variable is defined.

 Note:
By clicking on "**Auto Pos**", the position of the internal memory arrays where saving/getting the value of variable is automatically calculated.

 Note:
A variable can be added manually in "Variables in Read" and/or "Variables in Write" sections without scanning the OPC UA Server.

UPDATE DEVICE:

By pressing the **“Update Device”** button, it is possible to load the created Configuration into the device; and also the Firmware, if necessary. This by using the Ethernet port.

If you don't know the actual IP address of the device you have to use this procedure:

- Turn OFF the Device;
- Put Dip1 of 'Dip-Switch A' in ON position;
- Turn ON the device
- Connect the Ethernet cable;
- Insert the IP **“192.168.2.205”**;
- Select which operations you want to do;
- Press the **“Execute update firmware”** button to start the upload;
- When all the operations are “OK” turn OFF the Device;
- Put Dip1 of 'Dip-Switch A' in OFF position;
- Turn ON the device.

If you know the actual IP address of the device, you have to use this procedure:

- Turn ON the Device with the Ethernet cable inserted;
- Insert the actual IP of the Converter;
- Select which operations you want to do;
- Press the **“Execute update firmware”** button to start the upload;
- When all the operations are “OK” the device automatically goes at Normal Mode.

At this point the configuration/firmware on the device is correctly updated.

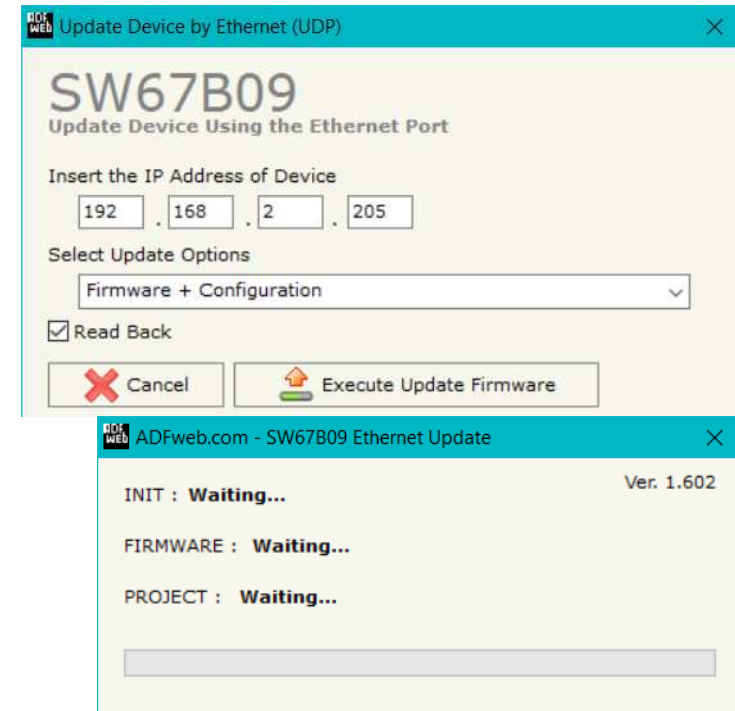

Figure 10: “Update device” windows

**Note:**

When you receive the device, for the first time, you also have to update the Firmware in the HD67B09 device.

**Warning:**

If Fig. 11 appears when you try to do the Update try these points before seeking assistance:

- Try to repeat the operations for the updating;
- Try with another PC;
- Try to restart the PC;
- Check the LAN settings;
- If you are using the program inside a Virtual Machine, try to use in the main Operating System;
- If you are using Windows Seven, Vista, 8 or 10 make sure that you have the administrator privileges;
- In case you have to program more than one device, using the "UDP Update", you have to cancel the ARP table every time you connect a new device on Ethernet. For do this you have to launch the "Command Prompt" and write the command "arp - d". Pay attention that with Windows Vista, Seven, 8, 10 you have to launch the "Command Prompt" with Administrator Rights;
- Pay attention at Firewall lock.

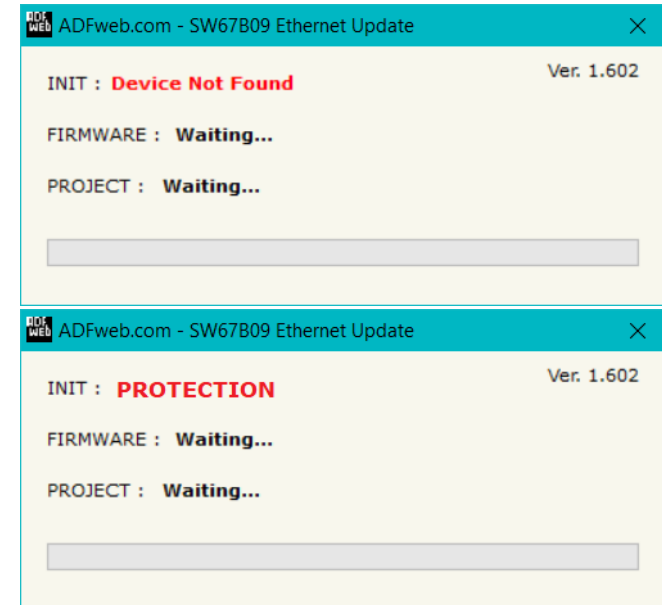

Figure 11: "Error" window

**Warning:**

In the case of HD67B09 you have to use the software "SW67B09": www.adfweb.com/download/filefold/SW67B09.zip.

MODBUS MAP:

On Modbus side, the map is created automatically.

Read with Input Register / Status Function not enabled

Data in reading:

Type	Address	Function	Description
Holding Register	0	04	Input Bytes (Position) 0-1 of internal array
Holding Register	1	04	Input Bytes (Position) 2-3 of internal array
Holding Register	2	04	Input Bytes (Position) 4-5 of internal array
.			
Holding Register	749	04	Input Bytes (Position) 1498-1499 of internal array

Data in writing:

Type	Address	Function	Description
Holding Register	0	R: 03 W: 06/16	Output Bytes 0-1 of internal array
Holding Register	1	R: 03 W: 06/16	Output Bytes 2-3 of internal array
Holding Register	2	R: 03 W: 06/16	Output Bytes 4-5 of internal array
.			
Holding Register	749	R: 03 W: 06/16	Output Bytes 1498-1499 of internal array



Note:

The data can be read/written as single bits too using Input/Coil Status (Function 02 and Functions 01/05/15).

Read with Input Register / Status Function enabled

Data in reading:

Type	Address	Function	Description
Input Register	0	04	Input Bytes (Position) 0-1 of internal array
Input Register	1	04	Input Bytes (Position) 2-3 of internal array
Input Register	2	04	Input Bytes (Position) 4-5 of internal array
.			
Input Register	749	04	Input Bytes (Position) 1498-1499 of internal array

Data in writing:

Type	Address	Function	Description
Holding Register	0	R: 03 W: 06/16	Output Bytes 0-1 of internal array
Holding Register	1	R: 03 W: 06/16	Output Bytes 2-3 of internal array
Holding Register	2	R: 03 W: 06/16	Output Bytes 4-5 of internal array
.			
Holding Register	749	R: 03 W: 06/16	Output Bytes 1498-1499 of internal array



Note:

The data can be read/written as single bits too using Input/Coil Status (Function 02 and Functions 01/05/15).

MECHANICAL DIMENSIONS:

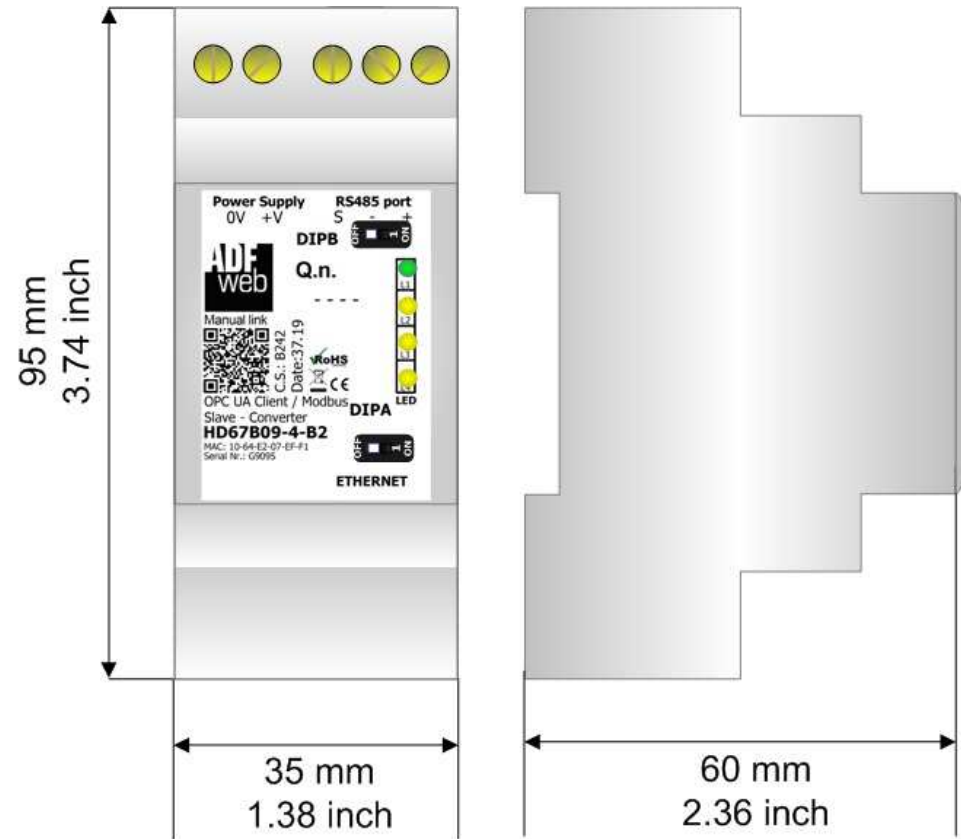

Housing: PVC
 Weight: 200g
 (Approx)

Figure 12: Mechanical dimensions scheme for HD67B09-x-B2

ORDERING INFORMATIONS:

The ordering part number is formed by a valid combination of the following:

HD67B09 - x - B 2

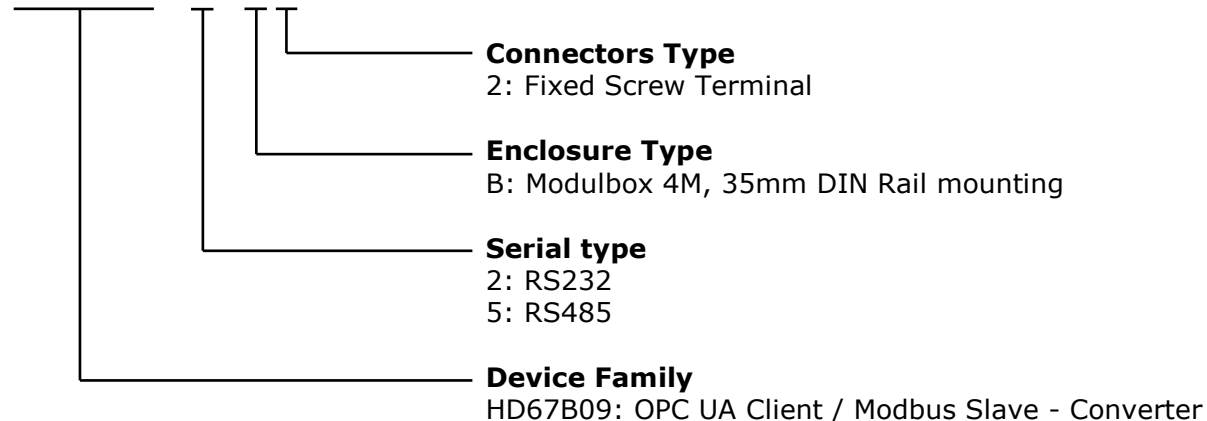

- Order Code: **HD67B09-2-A1** - OPC UA Client / Modbus Slave - Converter (Modbus port: RS232)
- Order Code: **HD67B09-5-A1** - OPC UA Client / Modbus Slave - Converter (Modbus port: RS485)

ACCESSORIES:

- Order Code: **AC34011** - 35mm Rail DIN - Power Supply 220/240V AC 50/60Hz – 12 V DC
- Order Code: **AC34012** - 35mm Rail DIN - Power Supply 220/240V AC 50/60Hz – 24 V DC

DISCLAIMER:

All technical content within this document can be modified without notice. The content of the document is a under continual renewal. For losses due to fire, earthquake, third party access or other accidents, or intentional or accidental abuse, misuse, or use under abnormal conditions repairs are charged to the user. ADFweb.com S.r.l. will not be liable for accidental loss of use or inability to use this product, such as loss of business income. ADFweb.com S.r.l. shall not be liable for consequences of improper use.

OTHER REGULATIONS AND STANDARDS:**WEEE INFORMATION**

Disposal of old electrical and electronic equipment (as in the European Union and other European countries with separate collection systems).

— This symbol on the product or on its packaging indicates that this product may not be treated as household rubbish. Instead, it should be taken to an applicable collection point for the recycling of electrical and electronic equipment. If the product is disposed correctly, you will help prevent potential negative environmental factors and impact of human health, which could otherwise be caused by inappropriate disposal. The recycling of materials will help to conserve natural resources. For more information about recycling this product, please contact your local city office, your household waste disposal service or the shop where you purchased the product.

RESTRICTION OF HAZARDOUS SUBSTANCES DIRECTIVE

The device respects the 2002/95/EC Directive on the restriction of the use of certain hazardous substances in electrical and electronic equipment (commonly referred to as Restriction of Hazardous Substances Directive or RoHS).

CE MARKING

The product conforms with the essential requirements of the applicable EC directives.

WARRANTIES AND TECHNICAL SUPPORT:

For fast and easy technical support for your ADFweb.com SRL products, consult our internet support at www.adfweb.com. Otherwise contact us at the address support@adfweb.com

RETURN POLICY:

If while using your product you have any problem and you wish to exchange or repair it, please do the following:

- ➔ Obtain a Product Return Number (PRN) from our internet support at www.adfweb.com. Together with the request, you need to provide detailed information about the problem.
- ➔ Send the product to the address provided with the PRN, having prepaid the shipping costs (shipment costs billed to us will not be accepted).

If the product is within the warranty of twelve months, it will be repaired or exchanged and returned within three weeks. If the product is no longer under warranty, you will receive a repair estimate.



ADFweb.com S.r.l.
Via Strada Nuova, 17
IT-31010 Mareno di Piave
TREVISO (Italy)
Phone +39.0438.30.91.31
Fax +39.0438.49.20.99
www.adfweb.com

