

User Manual

Revision 1.000
English

PROFINET Master / Serial - Converter

(Order Code: HD67B70-232-A1, HD67B70-485-A1, HD67B70-422-A1)

for Website information:

<http://www.adfweb.com/?Product=HD67B70>

for Price information:

<http://www.adfweb.com/?Price=HD67B70-232-A1>

<http://www.adfweb.com/?Price=HD67B70-485-A1>

<http://www.adfweb.com/?Price=HD67B70-422-A1>

Benefits and Main Features:

- ✦ Triple electrical isolation
- ✦ Two Ethernet ports
- ✦ Temperature range: -40°C/+85°C (-40°F/+185°F)



User Manual

For others PROFINET Master devices, see also the following links:

PROFINET Master from/to ...

- www.adfweb.com?Product=HD67B45
- www.adfweb.com?Product=HD67B71
- www.adfweb.com?Product=HD67B72
- www.adfweb.com?Product=HD67B73
- www.adfweb.com?Product=HD67B74
- www.adfweb.com?Product=HD67B75
- www.adfweb.com?Product=HD67B76
- www.adfweb.com?Product=HD67B77
- www.adfweb.com?Product=HD67B78
- www.adfweb.com?Product=HD67B79
- www.adfweb.com?Product=HD67B80
- www.adfweb.com?Product=HD67B81
- www.adfweb.com?Product=HD67B82
- www.adfweb.com?Product=HD67B84

- (OPC UA Server)
- (Modbus Slave)
- (PROFIBUS Slave)
- (CAN)
- (CANopen)
- (DeviceNet Slave)
- (Modbus TCP Slave)
- (SNMP Agent)
- (EtherNet/IP Slave)
- (KNX)
- (MQTT)
- (BACnet Slave)
- (IEC 61850 Server)
- (Ethernet)

Do you have an your customer protocol?

See the following links:

www.adfweb.com?Product=HD67003

Do you need to choose a device? do you want help?

Ask it to the following link:

www.adfweb.com?Cmd=helpme

INDEX:

	Page
INDEX	2
UPDATED DOCUMENTATION	2
REVISION LIST	2
WARNING	2
TRADEMARKS	2
SECURITY ALERT	3
EXAMPLE OF CONNECTION	4
CONNECTION SCHEME	5
CHARACTERISTICS	8
CONFIGURATION	8
POWER SUPPLY	9
FUNCTION MODES	10
LEDS	11
ETHERNET	12
RS232	12
RS485	13
RS422	14
USE OF COMPOSITOR SW67B70	15
NEW PROJECT / OPEN PROJECT	16
SOFTWARE OPTIONS	17
SET COMMUNICATION	19
PROFINET ACCESS	20
UPDATE DEVICE	23
SERIAL PROTOCOL	25
MECHANICAL DIMENSIONS	28
ORDERING INFORMATIONS	29
ACCESSORIES	29
DISCLAIMER	30
OTHER REGULATIONS AND STANDARDS	30
WARRANTIES AND TECHNICAL SUPPORT	31
RETURN POLICY	31

UPDATED DOCUMENTATION:

Dear customer, we thank you for your attention and we remind you that you need to check that the following document is:

- ✚ Updated
- ✚ Related to the product you own

To obtain the most recently updated document, note the “document code” that appears at the top right-hand corner of each page of this document.

With this “Document Code” go to web page www.adfweb.com/download/ and search for the corresponding code on the page. Click on the proper “Document Code” and download the updates.

REVISION LIST:

Revision	Date	Author	Chapter	Description
1.000	13/03/2020	Ff	All	First release version

WARNING:

ADFweb.com reserves the right to change information in this manual about our product without warning.

ADFweb.com is not responsible for any error this manual may contain.

TRADEMARKS:

All trademarks mentioned in this document belong to their respective owners.

SECURITY ALERT:**GENERAL INFORMATION**

To ensure safe operation, the device must be operated according to the instructions in the manual. When using the device, legal and safety regulation are required for each individual application. The same applies also when using accessories.

INTENDED USE

Machines and systems must be designed so the faulty conditions do not lead to a dangerous situation for the operator (i.e. independent limit switches, mechanical interlocks, etc.).

QUALIFIED PERSONNEL

The device can be used only by qualified personnel, strictly in accordance with the specifications.

Qualified personnel are persons who are familiar with the installation, assembly, commissioning and operation of this equipment and who have appropriate qualifications for their job.

RESIDUAL RISKS

The device is state-of-the-art and is safe. The instruments can represent a potential hazard if they are inappropriately installed and operated by untrained personnel. These instructions refer to residual risks with the following symbol:



This symbol indicates that non-observance of the safety instructions is a danger for people that could lead to serious injury or death and / or the possibility of damage.

CE CONFORMITY

The declaration is made by our company. You can send an email to support@adfweb.com or give us a call if you need it.

EXAMPLE OF CONNECTION:

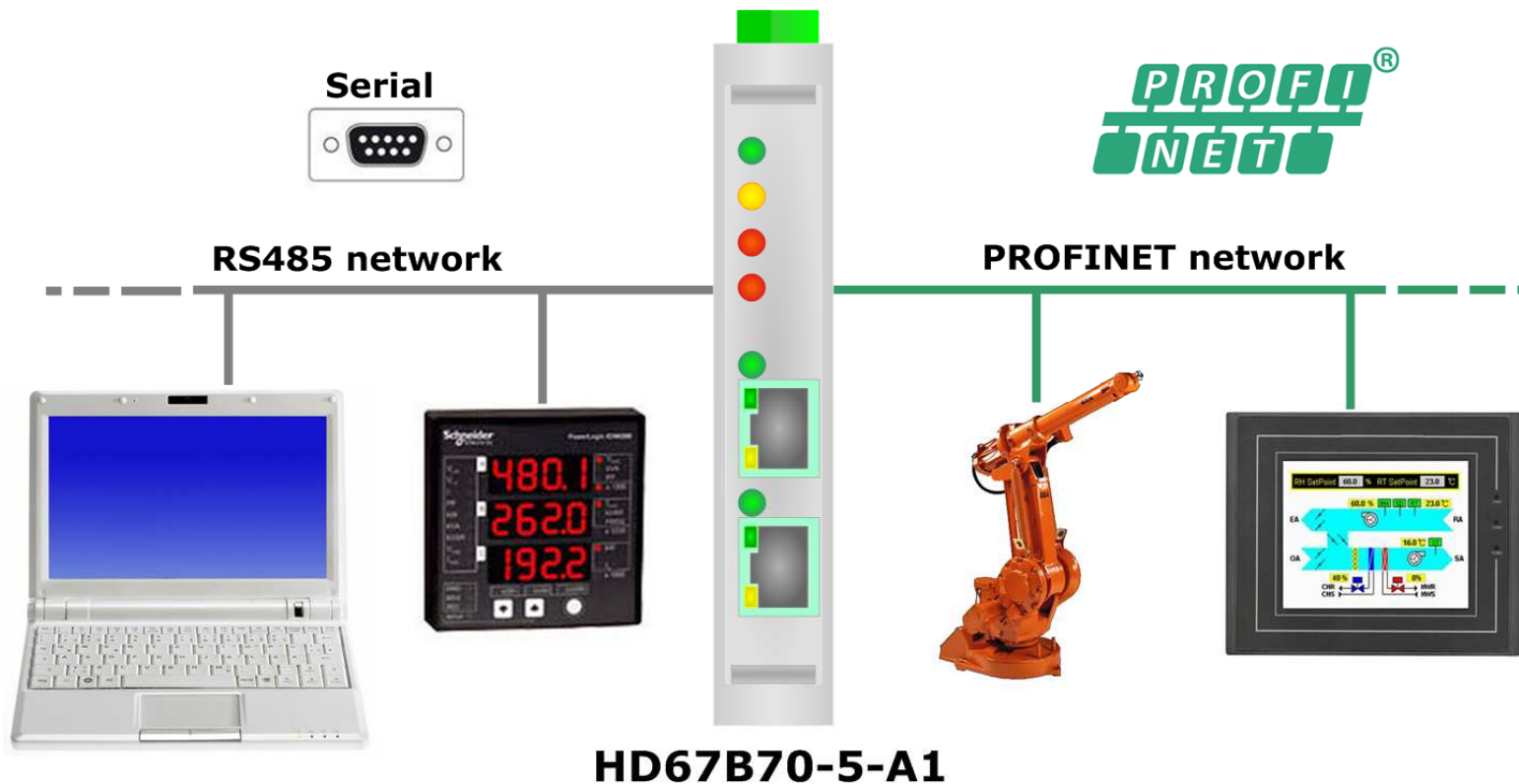

CONNECTION SCHEME:

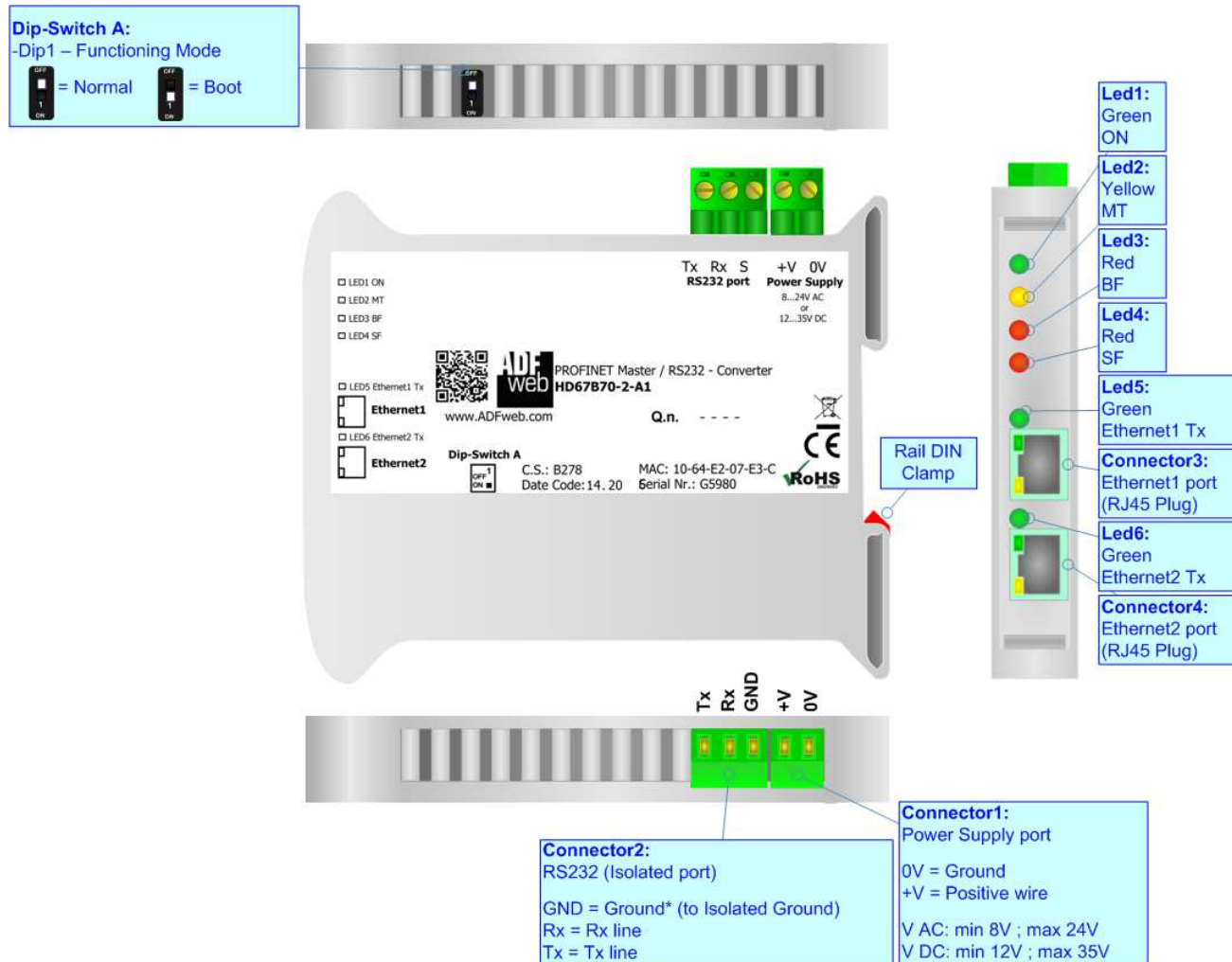

Figure 1a: Connection scheme for HD67B70-232-A1

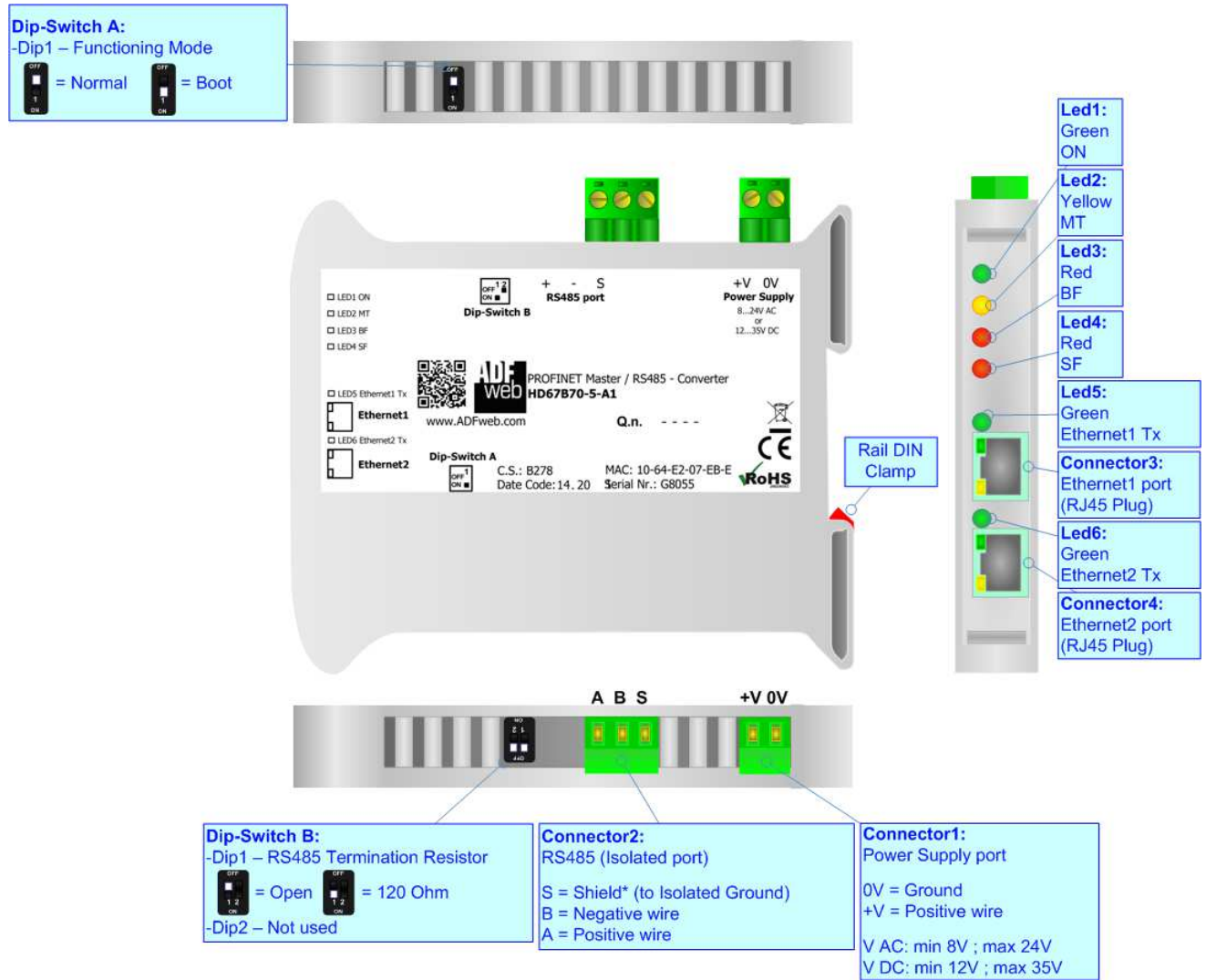

Figure 1b: Connection scheme for HD67B70-485-A1

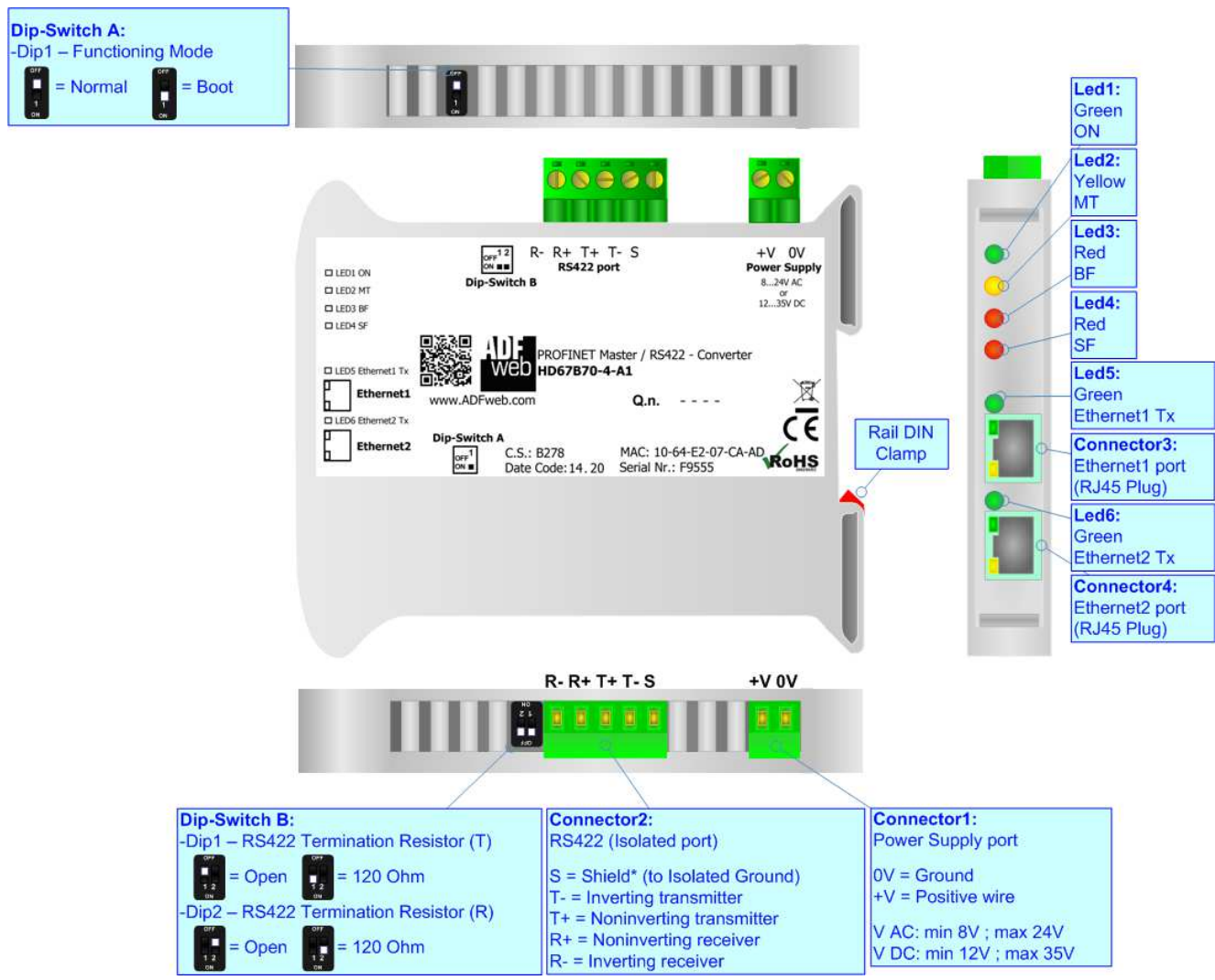

Figure 1c: Connection scheme for HD67B70-422-A1

CHARACTERISTICS:

The HD67B70-xxx-A1 is a PROFINET Master / Serial converter.

It allows the following characteristics:

- Triple isolation between Serial - Power Supply, Serial - Ethernet, Ethernet - Power Supply;
- Up to 4096 bytes in reading and 4096 bytes in writing;
- Two-directional information between Serial and PROFINET;
- Mountable on 35mm Rail DIN;
- Wide power supply input range: 8...24V AC or 12...35V DC;
- Wide temperature range: -40°C / 85°C [-40°F / +185°F].

CONFIGURATION:

You need Compositor SW67B70 software on your PC in order to perform the following:

- Define the parameter of the PROFINET;
- Define the parameter of the Serial;
- Define the list of PROFINET slaves connected to the converter;
- Update the device.

POWER SUPPLY:

The devices can be powered between a wide range of tensions. For more details see the two tables below.

	VAC		VDC	
	Vmin	Vmax	Vmin	Vmax
HD67B84-A1	8V	24V	12V	35V

Consumption at 24V DC:

Device	W/VA
HD67B70-xxx-A1	4



Caution: Not reverse the polarity power

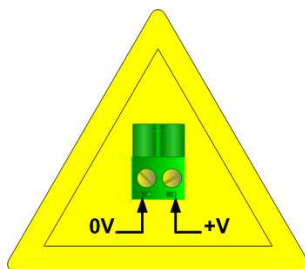

HD67B70-xxx-A1

Connector1:
 Power Supply port
 0V = Ground
 +V = Positive wire
 V AC: min 8V ; max 24V
 V DC: min 12V ; max 35V



FUNCTION MODES:

The device has got two functions mode depending of the position of the Dip1 of 'Dip-Switch A':

- The first, with Dip1 in Off position (factory setting), is used for the normal working of the device.
- The second, with Dip1 in On position, is used for upload the Project/Firmware.

For the operations to follow for the updating (see 'UPDATE DEVICE' section).

According to the functioning mode, the LEDs will have specifics functions (see 'LEDS' section).

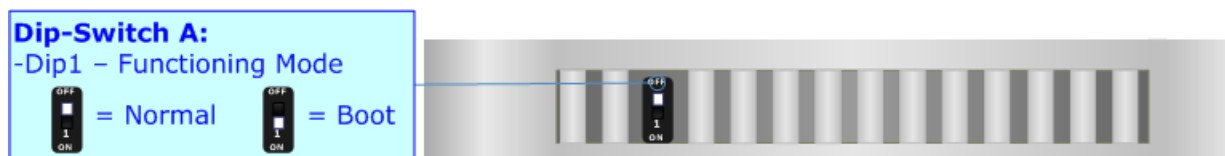

LEDS:

The device has got six LEDs that are used to give information of the functioning status. The various meanings of the LEDs are described in the table below.

LED	Normal Mode	Boot Mode
1: ON [supply voltage] (green)	ON: Device powered OFF: Device not powered	ON: Device powered OFF: Device not powered
2: MT [maintenance display] (yellow)	ON: Maintenance are present OFF: No maintenance are present	Blinks quickly: Boot state Blinks very slowly (~0.5Hz): update in progress
3: BF [bus fault] (red)	ON: The Ethernet connection is defective; the IP address exists several times in the network; the own NameOfStation exists several times in the network; no IP address has been set Flashing: At least one configured AR is no longer in the data exchange OFF: No errors are present	Blinks quickly: Boot state Blinks very slowly (~0.5Hz): update in progress
4: SF [group error] (red)	ON: At least one AR is not in the data exchange OFF: No errors are present	Blinks quickly: Boot state Blinks very slowly (~0.5Hz): update in progress
5: Ethernet1 Tx (green)	Blinks when is transmitting Ethernet frames	Blinks quickly: Boot state Blinks very slowly (~0.5Hz): update in progress
6: Ethernet2 Tx (green)	Blinks when is transmitting Ethernet frames	Blinks quickly: Boot state Blinks very slowly (~0.5Hz): update in progress

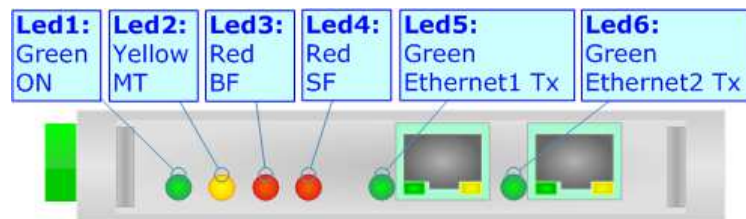

ETHERNET:

The Ethernet connection must be made using Connector3 or Connector4 of HD67B70-xxx-A1 with at least a Category 5E cable. The maximum length of the cable should not exceed 100m. The cable has to conform to the T568 norms relative to connections in cat.5 up to 100 Mbps. To connect the device to an Hub/Switch is recommended the use of a straight cable, to connect the device to a PC/PLC/other is recommended the use of a cross cable.

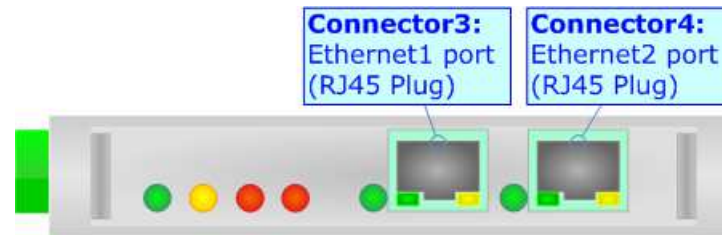

RS232:

The connection from RS232 socket to a serial port (example one from a personal computer) must be made with a Null Modem cable (a serial cable where the pins 2 and 3 are crossed). It is recommended that the RS232 cable not exceed 15 meters.

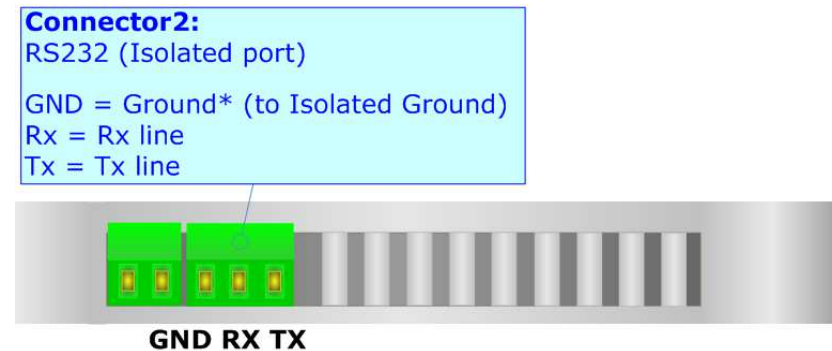

RS485:

For terminate the RS485 line with a 120Ω resistor it is necessary to put ON dip 1, like in figure.

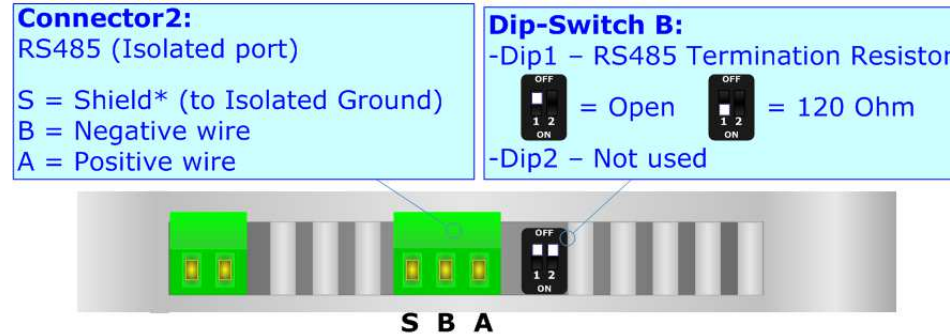

The maximum length of the cable should be 1200m (4000 feet).

Here some codes of cables:

- Belden: p/n 8132 - 2x 28AWG stranded twisted pairs conductor + foil shield + braid shield;
- Belden p/n 82842 - 2x 24AWG stranded twisted pairs conductor + foil shield + braid shield;
- Tasker: p/n C521 - 1x 24AWG twisted pair conductor + foil shield + braid shield;
- Tasker: p/n C522 - 2x 24AWG twisted pairs conductor + foil shield + braid shield.

RS422:

For terminating the RS422 line with a 120Ω resistor it is necessary to put ON dip 1 for T line and/or put ON dip 2 for R line, like in figure.



The maximum length of the cable should be 1200m (4000 feet).

USE OF COMPOSITOR SW67B70:

To configure the Converter, use the available software that runs with Windows called SW67B70. It is downloadable on the site www.adfweb.com and its operation is described in this document. *(This manual is referenced to the last version of the software present on our web site).* The software works with MSWindows (XP, Vista, Seven, 8, 10; 32/64bit).

When launching the SW67B70, the window below appears (Fig. 2).

 **Note:**
It is necessary to have installed .Net Framework 4.

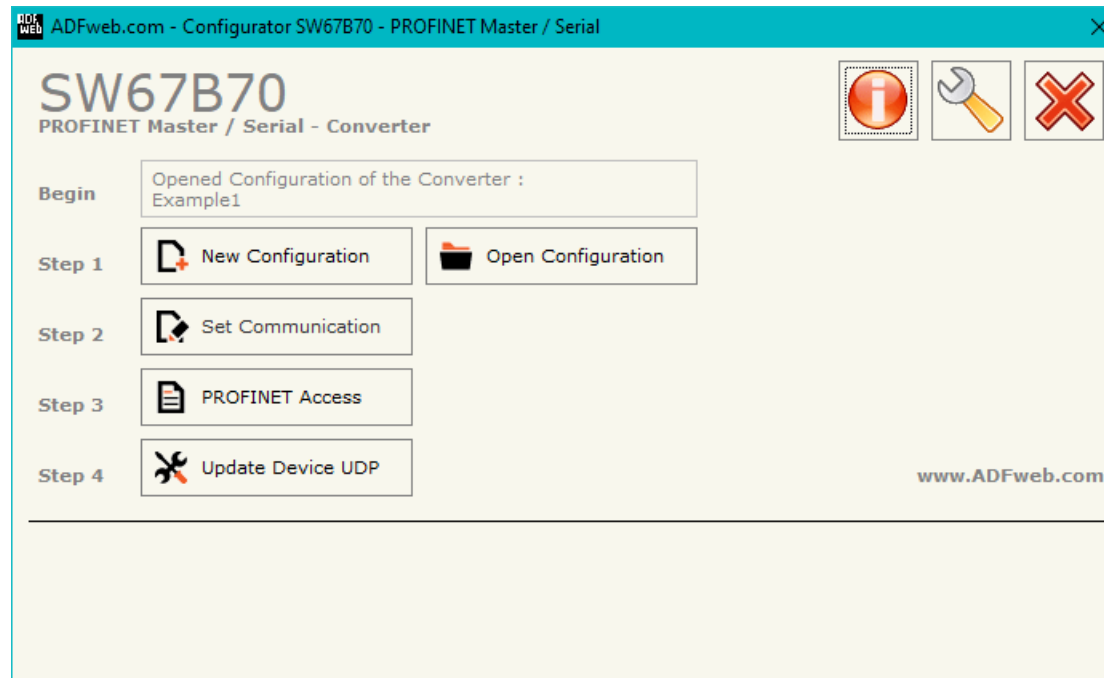
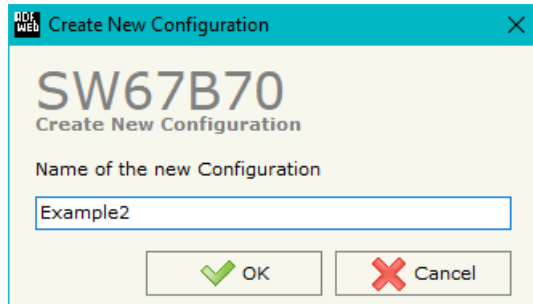

Figure 2: Main window for SW67B70

NEW CONFIGURATION / OPEN CONFIGURATION:

The “**New Configuration**” button creates the folder which contains the entire device’s configuration.



A device’s configuration can also be imported or exported:

- To clone the configurations of a programmable “PROFINET Master / Serial - Converter” in order to configure another device in the same manner, it is necessary to maintain the folder and all its contents;
- To clone a project in order to obtain a different version of the project, it is sufficient to duplicate the project folder with another name and open the new folder with the button “**Open Configuration**”.

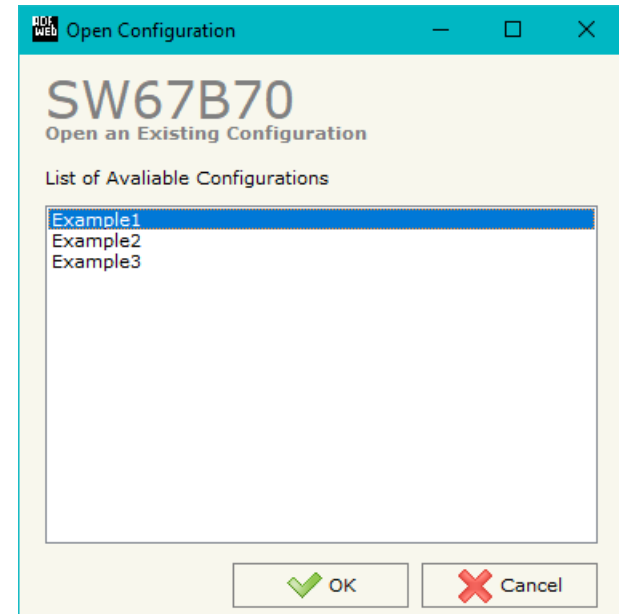

SOFTWARE OPTIONS:

By pressing the “**Settings**” () button there is the possibility to change the language of the software and check the updatings for the compositor.

In the section “Language” it is possible to change the language of the software.

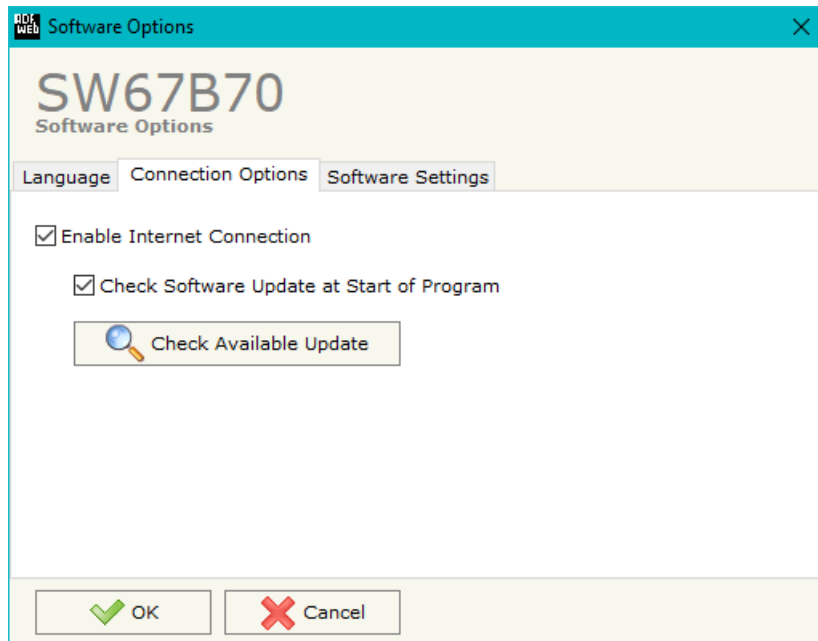

In the section “Connection Options”, it is possible to check if there are some updatings of the software compositor in ADFweb.com website. Checking the option “**Check Software Update at Start of Program**”, the SW67B70 check automatically if there are updatings when it is launched.

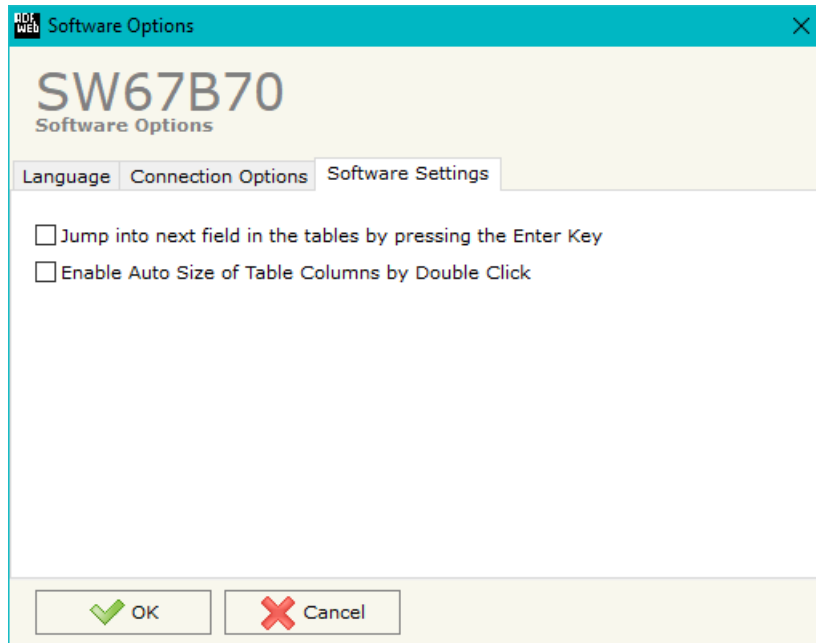

In the section "Software Settings", it is possible to enable/disable some keyboard's commands for an easier navigation inside the tables contained in the different sections of the software.

SET COMMUNICATION:

This section define the fundamental communication parameters of two buses, PROFINET and Serial.

By Pressing the **"Set Communication"** button from the main window for SW67B70 (Fig. 2) the window "Set Communication" appears (Fig. 3).

The means of the fields for "PROFINET Master" are:

- In the fields **"IP Address"** the IP address for PROFINET side of the converter is defined;
- In the fields **"SubNet Mask"** the SubNet Mask for PROFINET side of the converter is defined;
- In the fields **"Gateway"** the default gateway of the net is defined. This feature can be enabled or disabled pressing the Check Box field. This feature is used for going out of the net;
- In the field **"Name of Station"** the name of the PROFINET node is defined.

The means of the fields for "Serial" are:

- In the field **"Serial"** the serial line to use is defined;
- In the field **"Baudrate"** the baudrate for the serial line is defined;
- In the field **"Parity"** the parity of the serial line is defined;
- In the field **"Stop Bits"** the number of Stop Bits is defined.

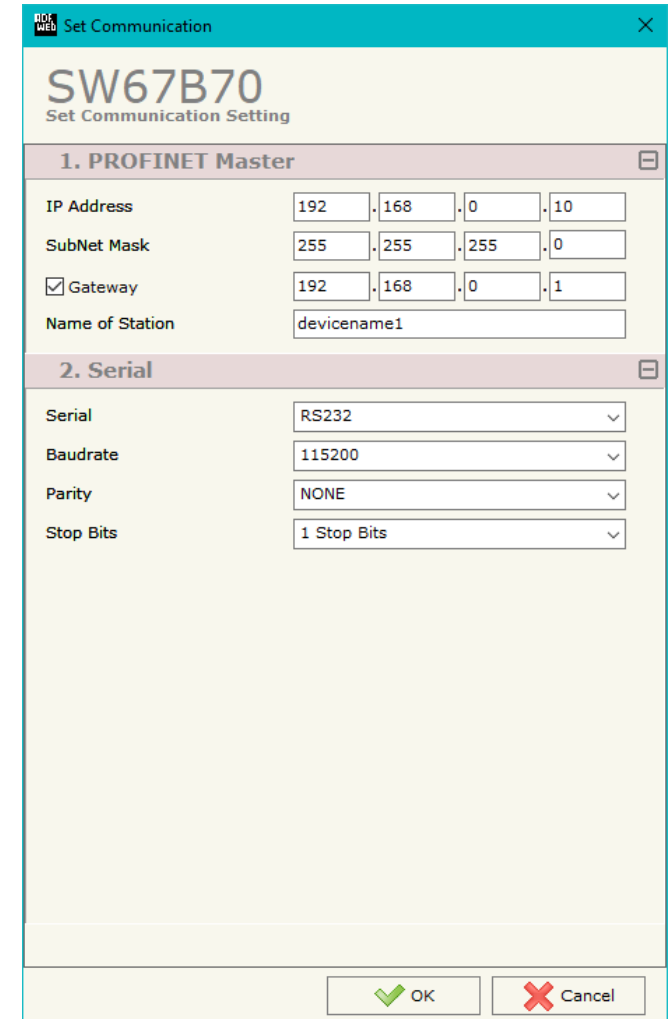

Figure 3: "Set Communication" window

PROFINET ACCESS:

By Pressing the “**PROFINET Access**” button from the main window for SW67B70 (Fig. 2) the window “Definition of PROFINET Devices Present in Network” appears (Fig. 4).

This section is used to define the list of the PROFINET slaves to read/write with the PROFINET Master. It is possible to add the PROFINET slaves from the hardware catalog. If a new device will be connected, it is possible to instal the GSDML file.

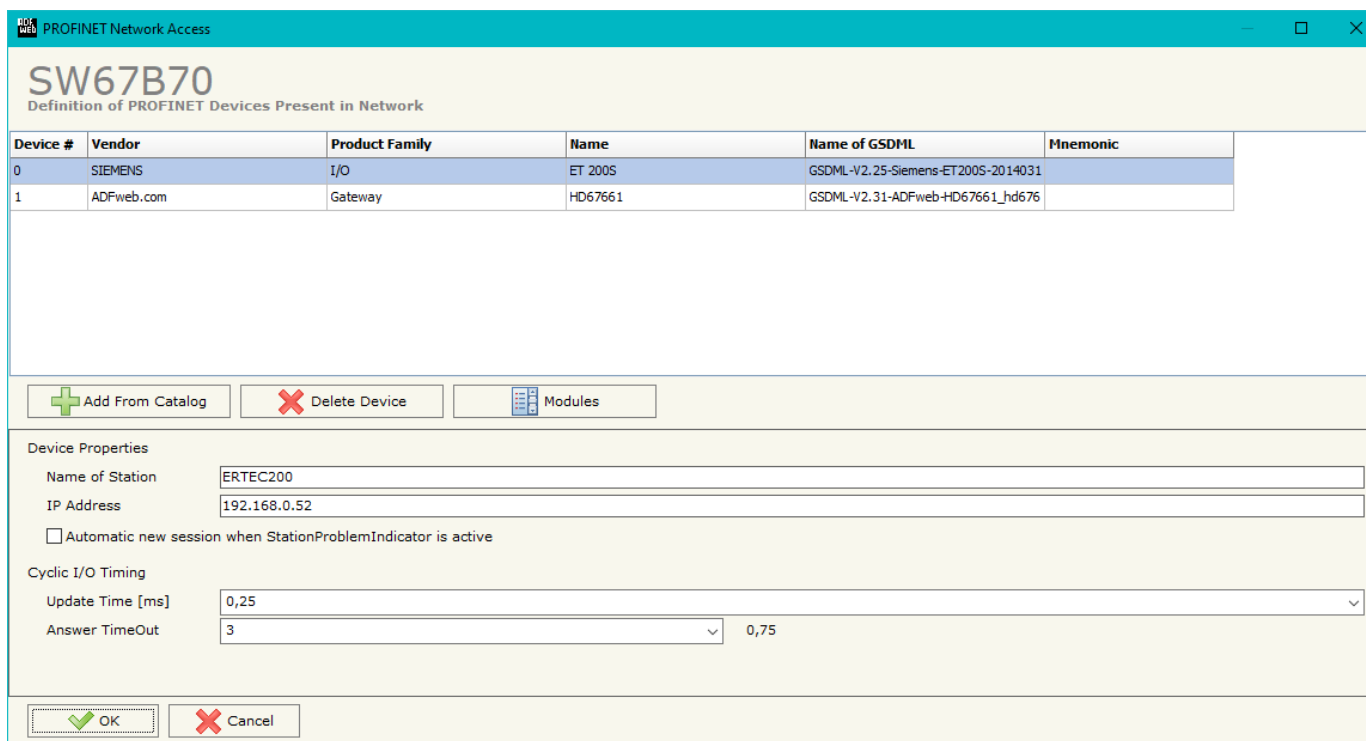

Figure 4: “Definition of PROFINET Devices Present in Network” window

The means of the fields below are:

- If the field "**Name of Station**" is checked, the name of the PROFINET slave is defined;
- In the field "**IP Address**" the IP Address of the PROFINET slave is defined;
- If the field "**Automatic new session when StationProblemIndicator is active**" is checked, the converter will restart the PROFINET communication when the error indicator in the slave is present;
- In the field "**Update Time [ms]**" the delay used for IO communication is defined;
- In the field "**Answer TimeOut**" the allowed number of cycles without response from the slave is defined.



Warning:

The data from/to the slaves are mapped consecutively into the IN/OUT PROFINET arrays, following the order with which they are defined.

By clicking on “**Modules**” button, it is possible to import the modules for the selected PROFINET slave device. The window “Definition Module and/or Submodules of PROFINET Device” appears (Fig. 5). In the main table it is possible to import the Modules of the PROFINET device in use. In the properties below, it is possible to set the parameters of the slave. These options depends on the slave in use, refer to the manual of the PROFINET device.

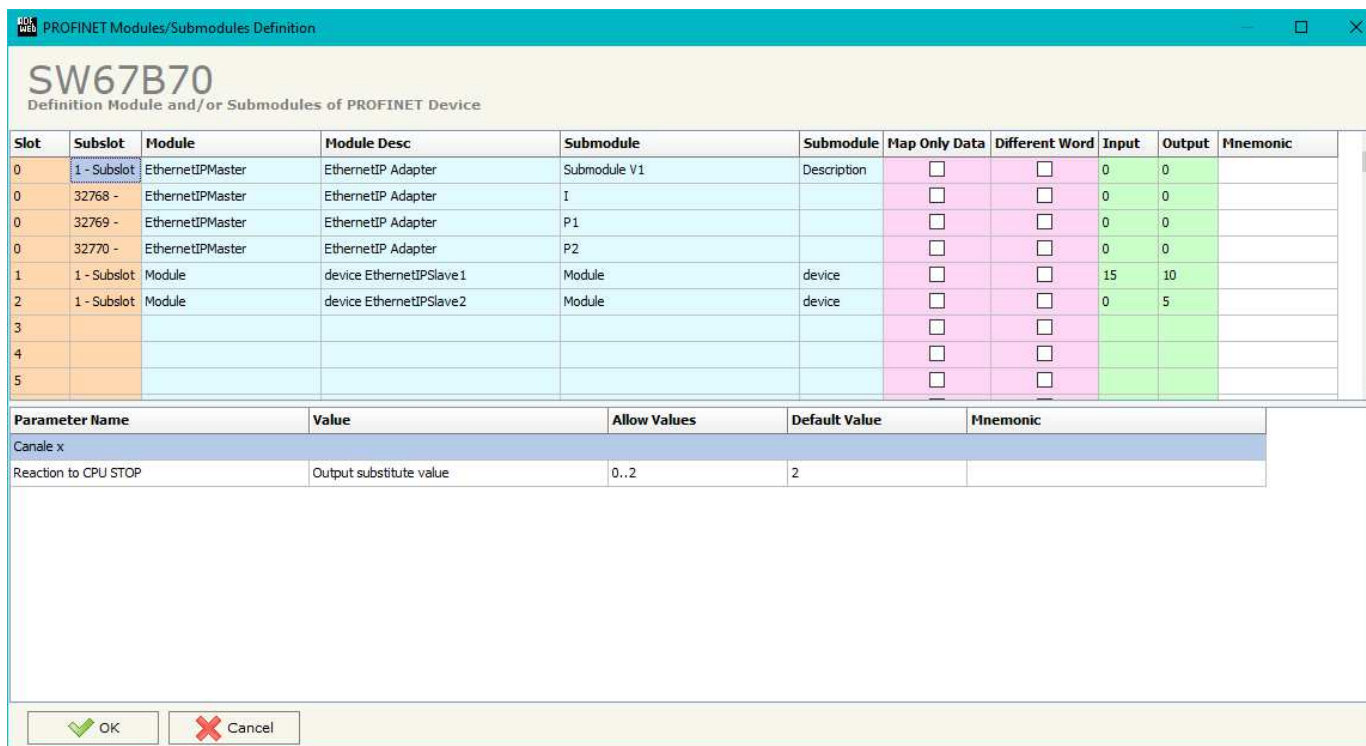

Figure 5: “Definition Module and/or Submodules of PROFINET Device” window

The means of the checkboxes inside the table are:

- If the field “**Map Only Data**” is checked, only the data of the modules are mapped into the PROFINET arrays. Otherwise, for each module there will be the status of IN and OUT areas too (1 byte);
- If the field “**Different Word**” is checked, the data of the different modules are mapped in different and consecutive words without splitting them.

UPDATE DEVICE:

By pressing the “**Update Device**” button, it is possible to load the created Configuration into the device; and also the Firmware, if necessary. This by using the Ethernet port.

If you don't know the actual IP address of the device you have to use this procedure:

- Turn OFF the Device;
- Put Dip2 of 'Dip-Switch A' in ON position;
- Turn ON the device
- Connect the Ethernet cable;
- Insert the IP “**192.168.2.205**”;
- Select which operations you want to do;
- Press the “**Execute update firmware**” button to start the upload;
- When all the operations are “OK” turn OFF the Device;
- Put Dip2 of 'Dip-Switch A' in OFF position;
- Turn ON the device.

If you know the actual IP address of the device, you have to use this procedure:

- Turn ON the Device with the Ethernet cable inserted;
- Insert the actual IP of the Converter;
- Select which operations you want to do;
- Press the “**Execute update firmware**” button to start the upload;
- When all the operations are “OK” the device automatically goes at Normal Mode.

At this point the configuration/firmware on the device is correctly updated.

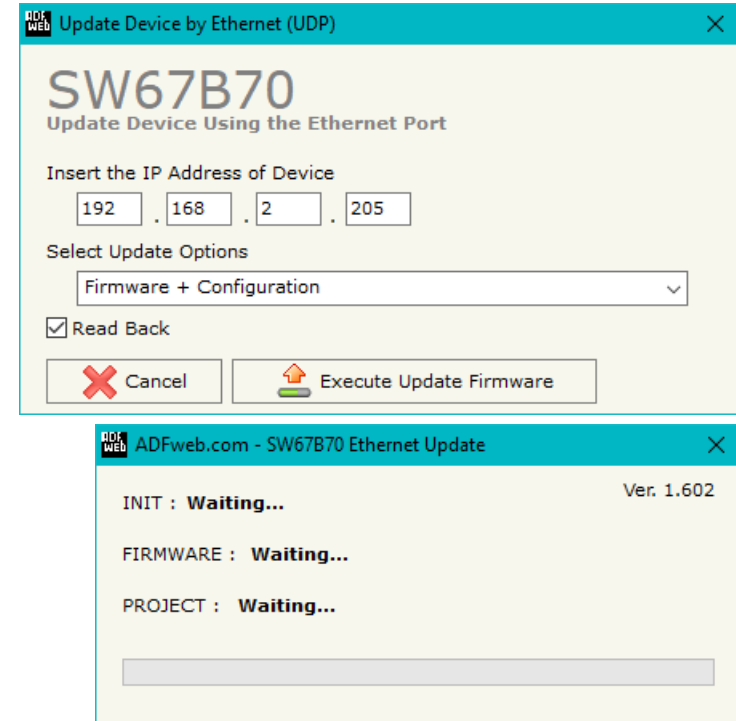

Figure 6: “Update device” windows



Note:

When you receive the device, for the first time, you also have to update the Firmware in the HD67B70 device.



Warning:

If Fig. 7 appears when you try to do the Update try these points before seeking assistance:

- Try to repeat the operations for the updating;
- Try with another PC;
- Try to restart the PC;
- Check the LAN settings;
- If you are using the program inside a Virtual Machine, try to use in the main Operating System;
- If you are using Windows Seven, Vista, 8 or 10 make sure that you have the administrator privileges;
- In case you have to program more than one device, using the "UDP Update", you have to cancel the ARP table every time you connect a new device on Ethernet. For do this you have to launch the "Command Prompt" and write the command "arp -d". Pay attention that with Windows Vista, Seven, 8, 10 you have to launch the "Command Prompt" with Administrator Rights;
- Pay attention at Firewall lock.

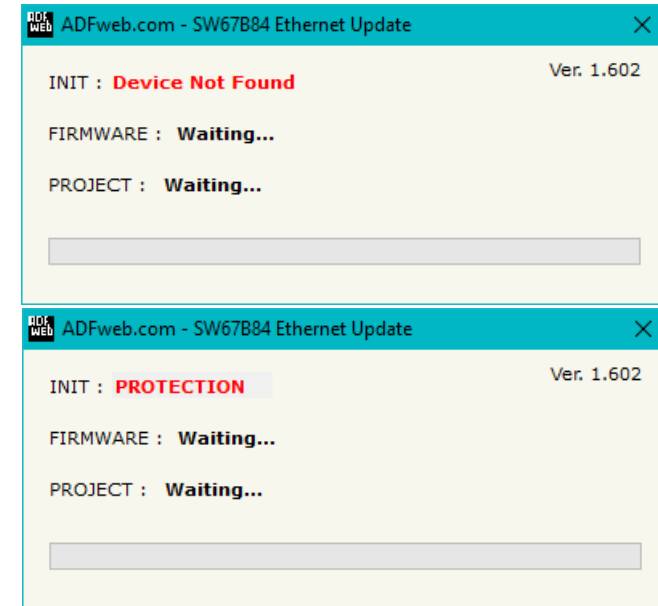

Figure 7: "Error" window



Warning:

In the case of HD67B70 you have to use the software "SW67B70": www.adfweb.com/download/filefold/SW67B70.zip.

SERIAL PROTOCOL:

In order to read and write the data from PROFINET side, it is enough to send some simple commands over serial port.

Reading data by PROFINET slave: this command allows to read all the data from a specific PROFINET slave.

Request:

Byte Number	Description
1	`R' (0x52)
2	`.' (0x2E)
3÷5	PROFINET slave to read (000÷009) (decimal) (*)

Response:

Byte Number	Description
1	`D' (0x44)
2	`:' (0x3A)
3÷n+2	Output byte of PROFINET slave (two chars for each byte)

*n=number of Output bytes of the slave

(*) The number of PROFINET slave depends on the order with which they are defined in the "PROFINET Access" section of SW67B70.

Reading data by PROFINET module: this command allows to read a specific module from a specific PROFINET slave.

Request:

Byte Number	Description
1	'R' (0x52)
2	`.` (0x2E)
3÷5	PROFINET slave to read (000÷009) (decimal) (*)
6	`.` (0x2E)
7÷9	PROFINET module to read (decimal) (**)

Response:

Byte Number	Description
1	'D' (0x44)
2	`.` (0x3A)
3÷n+2	Output byte of PROFINET slave (two chars for each byte)

*n=number of Output bytes of the selected module

(*) The number of PROFINET slave depends on the order with which they are defined in the "PROFINET Access" section of SW67B70.

(**) The number of PROFINET module of the selected slave depends on the order with which they are defined in the "PROFINET Access → Modules" section of SW67B70.

Writing data to PROFINET slaves: this command allows to write the data to a specific PROFINET slave.

Request:

Byte Number	Description
1	'W' (0x57)
2	',' (0x2E)
3÷5	PROFINET slave to read (000÷009) (decimal) (*)
6	',' (0x2E)
7÷9	Starting output byte to write (decimal)
10	',' (0x2E)
11÷13	Number of bytes to write (decimal)
14	'=' (0x3D)
15÷n+15	Data to write (hex)

*n=number of bytes defined in bytes 11-12-13 of the command

Response:

Byte Number	Description
1	'D' (0x44)
2	',' (0x3A)
3÷n+2	Output byte of PROFINET (two chars for each byte)

*n=number of Input bytes of the slave

(*) The number of PROFINET slave depends on the order with which they are defined in the "PROFINET Access" section of SW67B70.



Note:

It is possible to write up to 512 bytes with a single command.

MECHANICAL DIMENSIONS:

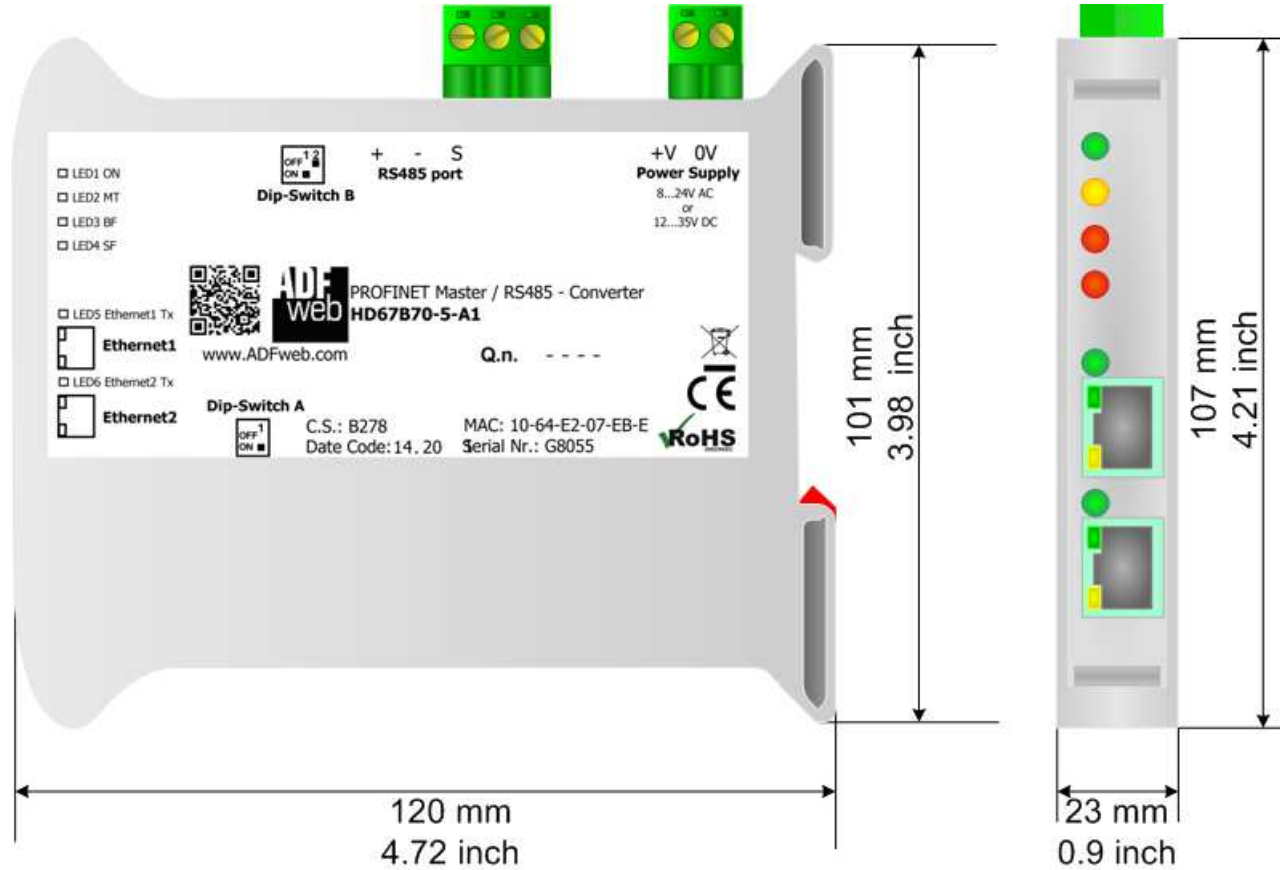

Housing: PVC
 Weight: 200g (Approx)

Figure 8: Mechanical dimensions scheme for HD67B70-xxx-A1

ORDERING INFORMATIONS:

The ordering part number is formed by a valid combination of the following:

HD67B70 - xxx - A 1

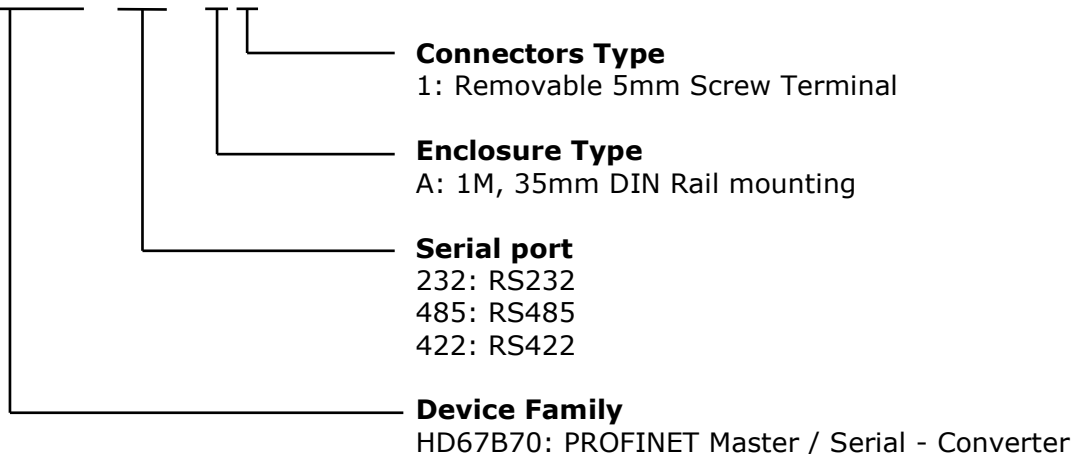

- Order Code: **HD67B70-232-A1** - PROFINET Master / Serial - Converter (Serial port: RS232)
- Order Code: **HD67B70-485-A1** - PROFINET Master / Serial - Converter (Serial port: RS485)
- Order Code: **HD67B70-422-A1** - PROFINET Master / Serial - Converter (Serial port: RS422)

ACCESSORIES:

- Order Code: **AC34011** - Rail DIN - Power Supply 220/240V AC 50/60Hz – 12 V DC
- Order Code: **AC34012** - Rail DIN - Power Supply 220/240V AC 50/60Hz – 24 V AC

DISCLAIMER:

All technical content within this document can be modified without notice. The content of the document is a under continual renewal. For losses due to fire, earthquake, third party access or other accidents, or intentional or accidental abuse, misuse, or use under abnormal conditions repairs are charged to the user. ADFweb.com S.r.l. will not be liable for accidental loss of use or inability to use this product, such as loss of business income. ADFweb.com S.r.l. shall not be liable for consequences of improper use.

OTHER REGULATIONS AND STANDARDS:**WEEE INFORMATION**

Disposal of old electrical and electronic equipment (as in the European Union and other European countries with separate collection systems).

— This symbol on the product or on its packaging indicates that this product may not be treated as household rubbish. Instead, it should be taken to an applicable collection point for the recycling of electrical and electronic equipment. If the product is disposed correctly, you will help prevent potential negative environmental factors and impact of human health, which could otherwise be caused by inappropriate disposal. The recycling of materials will help to conserve natural resources. For more information about recycling this product, please contact your local city office, your household waste disposal service or the shop where you purchased the product.

RESTRICTION OF HAZARDOUS SUBSTANCES DIRECTIVE

The device respects the 2002/95/EC Directive on the restriction of the use of certain hazardous substances in electrical and electronic equipment (commonly referred to as Restriction of Hazardous Substances Directive or RoHS).

CE MARKING

The product conforms with the essential requirements of the applicable EC directives.

WARRANTIES AND TECHNICAL SUPPORT:

For fast and easy technical support for your ADFweb.com SRL products, consult our internet support at www.adfweb.com. Otherwise contact us at the address support@adfweb.com

RETURN POLICY:

If while using your product you have any problem and you wish to exchange or repair it, please do the following:

- ➔ Obtain a Product Return Number (PRN) from our internet support at www.adfweb.com. Together with the request, you need to provide detailed information about the problem.
- ➔ Send the product to the address provided with the PRN, having prepaid the shipping costs (shipment costs billed to us will not be accepted).

If the product is within the warranty of twelve months, it will be repaired or exchanged and returned within three weeks. If the product is no longer under warranty, you will receive a repair estimate.



ADFweb.com S.r.l.
 Via Strada Nuova, 17
 IT-31010 Mareno di Piave
 TREVISO (Italy)
 Phone +39.0438.30.91.31
 Fax +39.0438.49.20.99
www.adfweb.com

