

# User Manual

Revision 1.001

English

## EtherCAT / CAN - Converter

(Order Code: HD67E07-A1 )

For Website information:

[www.adfweb.com?Product=HD67E07](http://www.adfweb.com?Product=HD67E07)

For Price information:

[www.adfweb.com?Price=HD67E07-A1](http://www.adfweb.com?Price=HD67E07-A1)

### Benefits and Main Features:

- ⊕ Very easy to configure
- ⊕ Triple Electrical isolation
- ⊕ Temperature range: -40°C/+85°C (-40°F/+185°F)



For other EtherCAT Slave products see also the following link:

#### Converter EtherCAT Slave to

- [www.adfweb.com?Product=HD67E00](http://www.adfweb.com?Product=HD67E00)
- [www.adfweb.com?Product=HD67E01](http://www.adfweb.com?Product=HD67E01)
- [www.adfweb.com?Product=HD67E02](http://www.adfweb.com?Product=HD67E02)
- [www.adfweb.com?Product=HD67E03](http://www.adfweb.com?Product=HD67E03)
- [www.adfweb.com?Product=HD67E04](http://www.adfweb.com?Product=HD67E04)
- [www.adfweb.com?Product=HD67E05](http://www.adfweb.com?Product=HD67E05)
- [www.adfweb.com?Product=HD67E06](http://www.adfweb.com?Product=HD67E06)
- [www.adfweb.com?Product=HD67E08](http://www.adfweb.com?Product=HD67E08)
- [www.adfweb.com?Product=HD67E09](http://www.adfweb.com?Product=HD67E09)
- [www.adfweb.com?Product=HD67E10](http://www.adfweb.com?Product=HD67E10)
- [www.adfweb.com?Product=HD67E11](http://www.adfweb.com?Product=HD67E11)
- [www.adfweb.com?Product=HD67E12](http://www.adfweb.com?Product=HD67E12)
- [www.adfweb.com?Product=HD67E14](http://www.adfweb.com?Product=HD67E14)
- [www.adfweb.com?Product=HD67E15](http://www.adfweb.com?Product=HD67E15)
- [www.adfweb.com?Product=HD67E16](http://www.adfweb.com?Product=HD67E16)
- [www.adfweb.com?Product=HD67E17](http://www.adfweb.com?Product=HD67E17)
- [www.adfweb.com?Product=HD67E18](http://www.adfweb.com?Product=HD67E18)
- [www.adfweb.com?Product=HD67E19](http://www.adfweb.com?Product=HD67E19)
- [www.adfweb.com?Product=HD67E20](http://www.adfweb.com?Product=HD67E20)
- [www.adfweb.com?Product=HD67E21](http://www.adfweb.com?Product=HD67E21)
- [www.adfweb.com?Product=HD67E22](http://www.adfweb.com?Product=HD67E22)
- [www.adfweb.com?Product=HD67E23](http://www.adfweb.com?Product=HD67E23)
- [www.adfweb.com?Product=HD67E24](http://www.adfweb.com?Product=HD67E24)
- [www.adfweb.com?Product=HD67E25](http://www.adfweb.com?Product=HD67E25)
- [www.adfweb.com?Product=HD67E26](http://www.adfweb.com?Product=HD67E26)
- [www.adfweb.com?Product=HD67E27](http://www.adfweb.com?Product=HD67E27)
- [www.adfweb.com?Product=HD67E28](http://www.adfweb.com?Product=HD67E28)
- [www.adfweb.com?Product=HD67879](http://www.adfweb.com?Product=HD67879)

- (Serial)
- (Modbus Master)
- (Modbus Slave)
- (Modbus TCP Master)
- (Modbus TCP Slave)
- (BACnet Master)
- (BACnet Slave)
- (CANopen)
- (DeviceNet Master)
- (DeviceNet Slave)
- (DMX)
- (Ethernet)
- (IEC61850 Client)
- (IEC61850 Server)
- (J1939)
- (MQTT)
- (NMEA0183)
- (NMEA2000)
- (OPC UA Client)
- (OPC UA Server)
- (PROFINET Master)
- (PROFINET Slave)
- (SNMP Manager)
- (SNMP Agent)
- (EtherNet/IP Master)
- (EtherNet/IP Slave)
- (S7comm Client)
- (IO-Link Master)



User Manual

**INDEX:**

	Page
INDEX	2
UPDATED DOCUMENTATION	2
REVISION LIST	2
WARNING	2
TRADEMARKS	2
SECURITY ALERT	3
EXAMPLE OF CONNECTION	4
CONNECTION SCHEME	5
CHARACTERISTICS	6
CONFIGURATION	6
POWER SUPPLY	7
FUNCTION MODES	8
LEDS	9
ETHERCAT	10
CAN	11
ETHERNET	12
USE OF COMPOSITOR SW67E07	13
NEW CONFIGURATION / OPEN CONFIGURATION	14
SOFTWARE OPTIONS	15
SET COMMUNICATION	17
ETHERCAT SET ACCESS	18
RECEIVE FRAMES	20
SEND FRAMES	22
ETHERCAT ESI FILE	23
UPDATE DEVICE	24
MECHANICAL DIMENSIONS	26
ORDERING INFORMATIONS	27
ACCESSORIES	27
DISCLAIMER	28
OTHER REGULATIONS AND STANDARDS	28
WARRANTIES AND TECHNICAL SUPPORT	29
RETURN POLICY	29

**UPDATED DOCUMENTATION:**

Dear customer, we thank you for your attention and we remind you that you need to check that the following document is:

- ✚ Updated
- ✚ Related to the product you own

To obtain the most recently updated document, note the “document code” that appears at the top right-hand corner of each page of this document.

With this “Document Code” go to web page [www.adfweb.com/download/](http://www.adfweb.com/download/) and search for the corresponding code on the page. Click on the proper “Document Code” and download the updates.

**REVISION LIST:**

Revision	Date	Author	Chapter	Description
1.000	18/09/2020	Ff	All	First Release
1.001	23/03/2022	Ff	All	Revision

**WARNING:**

ADFweb.com reserves the right to change information in this manual about our product without warning.  
ADFweb.com is not responsible for any error this manual may contain.

**TRADEMARKS:**

All trademarks mentioned in this document belong to their respective owners.

**SECURITY ALERT:****GENERAL INFORMATION**

To ensure safe operation, the device must be operated according to the instructions in the manual. When using the device, legal and safety regulation are required for each individual application. The same applies also when using accessories.

**INTENDED USE**

Machines and systems must be designed so the faulty conditions do not lead to a dangerous situation for the operator (i.e. independent limit switches, mechanical interlocks, etc.).

**QUALIFIED PERSONNEL**

The device can be used only by qualified personnel, strictly in accordance with the specifications. Qualified personnel are persons who are familiar with the installation, assembly, commissioning and operation of this equipment and who have appropriate qualifications for their job.

**RESIDUAL RISKS**

The device is state-of-the-art and is safe. The instruments can represent a potential hazard if they are inappropriately installed and operated by untrained personnel. These instructions refer to residual risks with the following symbol:



This symbol indicates that non-observance of the safety instructions is a danger for people that could lead to serious injury or death and / or the possibility of damage.

**CE CONFORMITY**

The declaration is made by our company. You can send an email to [support@adfweb.com](mailto:support@adfweb.com) or give us a call if you need it.

**EXAMPLE OF CONNECTION:**

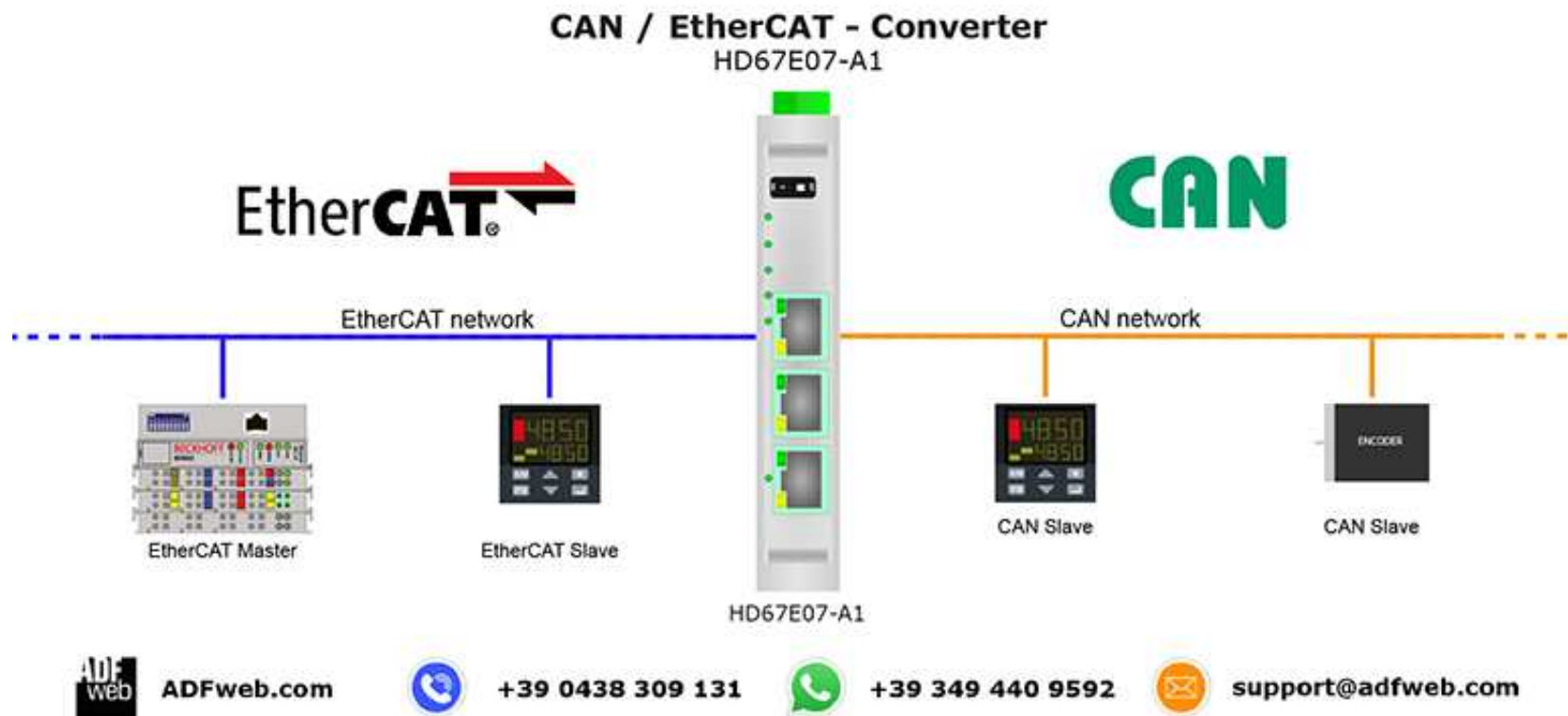

**CONNECTION SCHEME:**

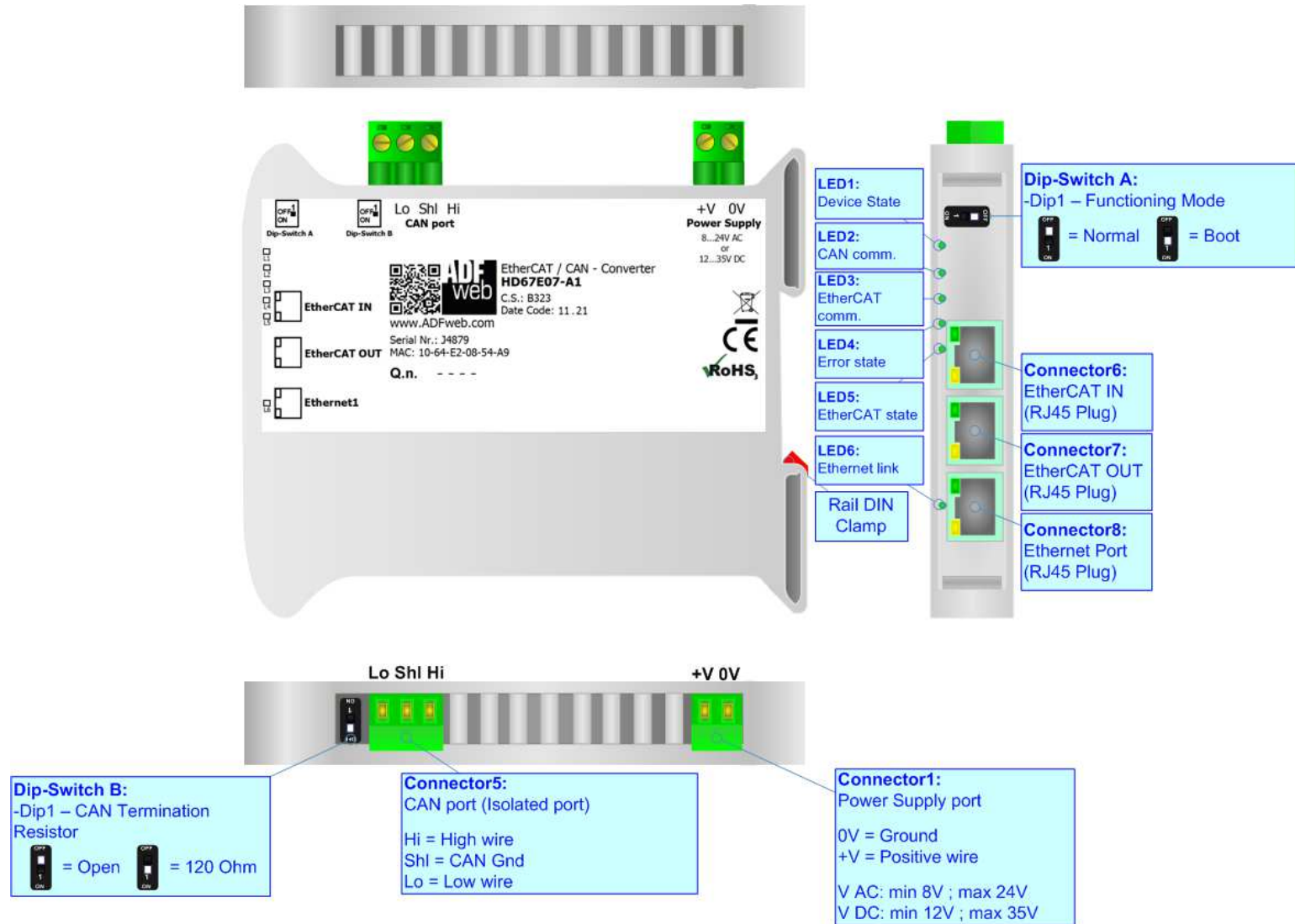

Figure 1: Connection scheme for HD67E07-A1

**CHARACTERISTICS:**

The HD67E07-A1 are EtherCAT / CAN - Converters.

It allows for the following characteristics:

- Isolation between EtherCAT – CAN – Power Supply;
- Two-directional information between EtherCAT bus and CAN bus;
- Mountable on 35mm Rail DIN;
- Wide power supply input range: 8...24V AC or 12...35V DC;
- Wide temperature range: -40°C / 85°C [-40°F / +185°F].



**CONFIGURATION:**

You need Compositor SW67E07 software on your PC in order to perform the following:

- Define the parameters of EtherCAT line;
- Define the parameters of CAN line;
- Define EtherCAT variables to read and write;
- Define CAN messages in rx and tx;;
- Export the ESI file for configuration of EtherCAT Master;
- Update the device.

**POWER SUPPLY:**

The devices can be powered at 8...24V AC and 12...35V DC. For more details see the two tables below.

VAC 		VDC 	
Vmin	Vmax	Vmin	Vmax
8V	24V	12V	35V

Consumption at 24V DC:

Device	Consumption [W/VA]
HD67E07-A1	3.5

**Connector1:**  
Power Supply port  
0V = Ground  
+V = Positive wire  
V AC: min 8V ; max 24V  
V DC: min 12V ; max 35V

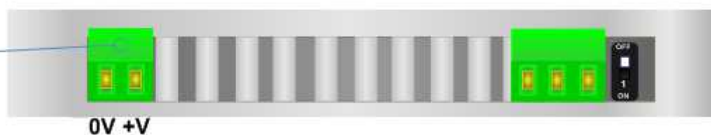

**Caution: Do not reverse the polarity power**

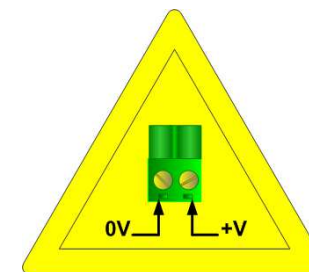

HD67E07-A1

**FUNCTION MODES:**

The device has got two function modes depending on the position of the 'Dip1 of Dip-Switch A':

- The first, with 'Dip1 of Dip-Switch A' at "OFF" position, is used for the normal working of the device.
- The second, with 'Dip1 of Dip-Switch A' at "ON" position, is used for uploading the Project and/or Firmware.

For the operations to follow for the updating, see 'UPDATE DEVICE' section.

According to the functioning mode, the LEDs will have specific functions, see 'LEDS' section.

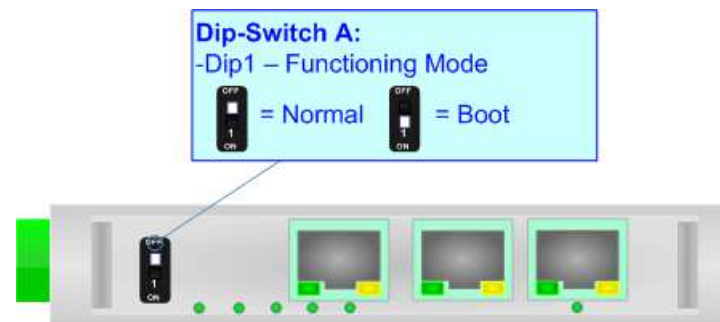



**LEDS:**

The device has got seven LEDs that are used to give information about the functioning status. The various meanings of the LEDs are described in the table below.

LED	Normal Mode	Boot Mode
1: Device State (green)	Blinks slowly (~1Hz)	<b>Blinks quickly:</b> Boot state <b>Blinks very slowly (~0.5Hz):</b> update in progress
2: CAN comm. (green)	It blinks when a CAN message is received	<b>Blinks quickly:</b> Boot state <b>Blinks very slowly (~0.5Hz):</b> update in progress
3: EtherCAT comm. (green)	It blinks when EtherCAT communication is running	<b>Blinks quickly:</b> Boot state <b>Blinks very slowly (~0.5Hz):</b> update in progress
4: Error state (green)	<b>ON:</b> An error in the communication busses occurs <b>OFF:</b> No errors are present	<b>Blinks quickly:</b> Boot state <b>Blinks very slowly (~0.5Hz):</b> update in progress
5: EtherCAT state (green)	<b>OFF:</b> EtherCAT Master not connected <b>Blinking:</b> EtherCAT Master is connecting <b>ON:</b> EtherCAT Master is connected	<b>Blinks quickly:</b> Boot state <b>Blinks very slowly (~0.5Hz):</b> update in progress
6: Ethernet1 link (green)	<b>ON:</b> Ethernet cable connected <b>OFF:</b> Ethernet cable disconnected	<b>ON:</b> Ethernet cable connected <b>OFF:</b> Ethernet cable disconnected

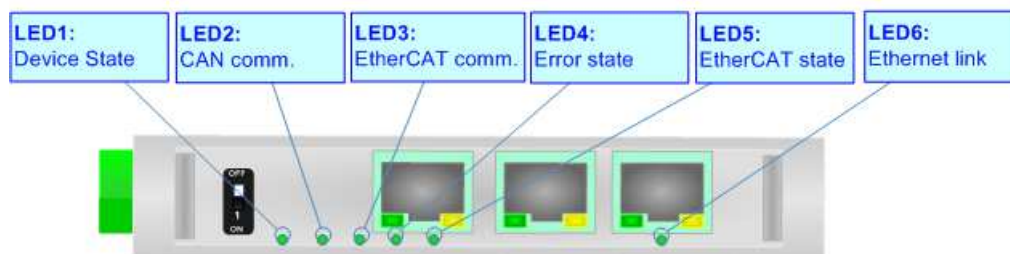

## ETHERCAT

**EtherCAT** (Ethernet for Control Automation Technology) is an Ethernet-based fieldbus system, invented by Beckhoff Automation.

The protocol is standardized in IEC 61158 and is suitable for both hard and soft real-time computing requirements in automation technology. With EtherCAT, the standard Ethernet packet or frame (according to IEEE 802.3) is no longer received, interpreted, and copied as process data at every node. The EtherCAT slave devices read the data addressed to them while the telegram passes through the device, processing data "on the fly". In other words, real-time data and messages are prioritized over more general, less time-sensitive or heavy load data.

The converter has two EtherCAT ports, one is used as Input port (Connector6) and it will receive the incoming messages from the Master, the other is used as Output port (Connector7) and it will forward the messages to the others nodes of the network.

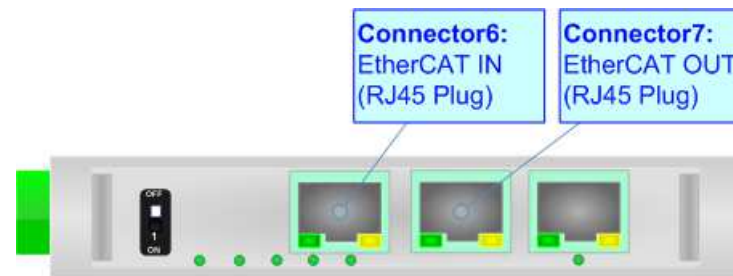

**CAN:**

For terminating the CAN line with a 120Ω resistor it is necessary that the Dip1 of 'Dip-Switch B' is at ON position.

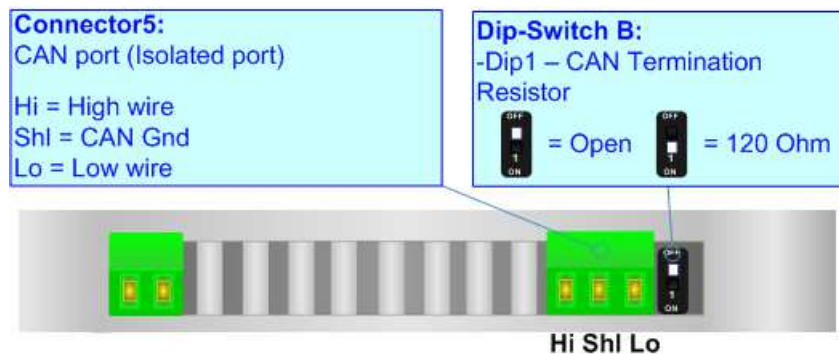

Cable characteristics:

<b>DC parameter:</b>	Impedance	70 Ohm/m
<b>AC parameters:</b>	Impedance	120 Ohm/m
	Delay	5 ns/m
<b>Length</b>	<b>Baud Rate [bps]</b>	<b>Length MAX [m]</b>
	10 K	5000
	20 K	2500
	50 K	1000
	100 K	650
	125 K	500
	250 K	250
	500 K	100
	800 K	50
	1000 K	25

**ETHERNET:**

The updating of the converter must be made using Connector8 of the HD67E07-A1 with at least a Category 5E cable. The maximum length of the cable should not exceed 100m. The cable has to conform to the T568 norms relative to connections in cat.5 up to 100 Mbps. To connect the device to an Hub/Switch is recommended the use of a straight cable, to connect the device to a PC/PLC/other is recommended the use of a cross cable.

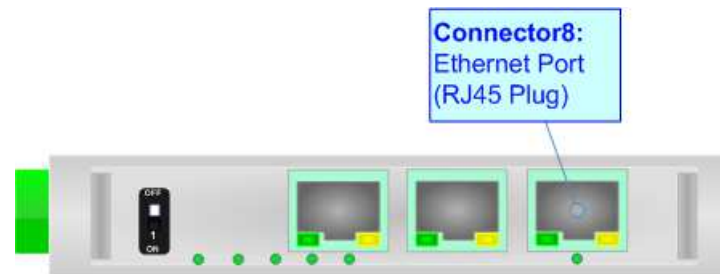

### USE OF COMPOSITOR SW67E07:

To configure the Converter, use the available software that runs with Windows called SW67E07. It is downloadable on the site [www.adfweb.com](http://www.adfweb.com) and its operation is described in this document. *(This manual is referenced to the last version of the software present on our web site).* The software works with MSWindows (XP, Vista, Seven, 8, 10; 32/64bit).

When launching the SW67E07, the window below appears (Fig. 2).



**Note:**

It is necessary to have installed .Net Framework 4.

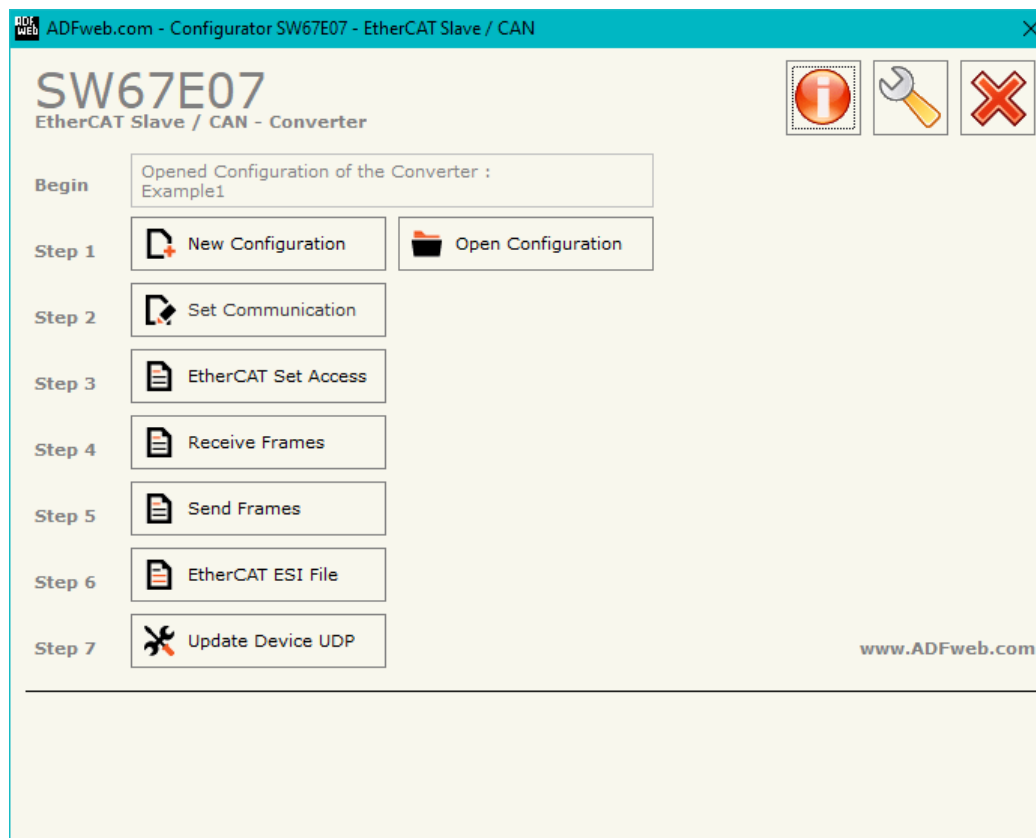
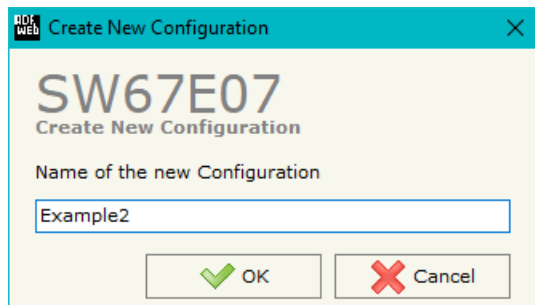

Figure 2: Main window for SW67E07

**NEW CONFIGURATION / OPEN CONFIGURATION:**

The “**New Configuration**” button creates the folder which contains the entire device’s configuration.



A device’s configuration can also be imported or exported:

- To clone the configurations of a programmable “EtherCAT Slave / CAN - Converter” in order to configure another device in the same manner, it is necessary to maintain the folder and all its contents;
- To clone a project in order to obtain a different version of the project, it is sufficient to duplicate the project folder with another name and open the new folder with the button “**Open Configuration**”.

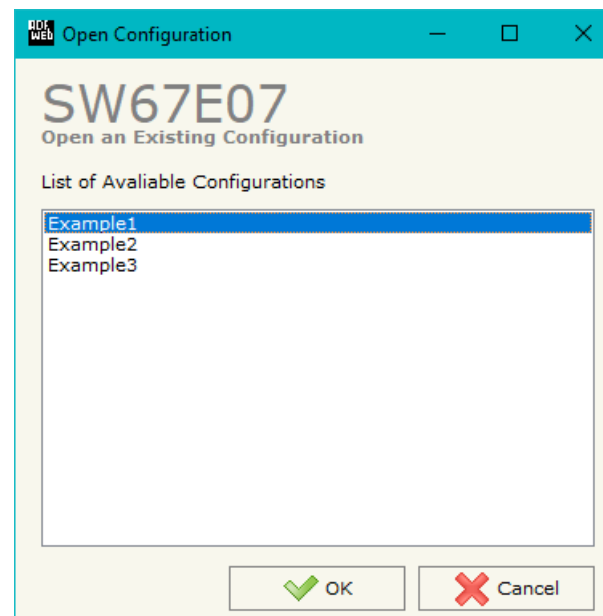

**SOFTWARE OPTIONS:**

By pressing the “**Settings**” () button there is the possibility to change the language of the software and check the updatings for the compositor.

In the section “Language” it is possible to change the language of the software.

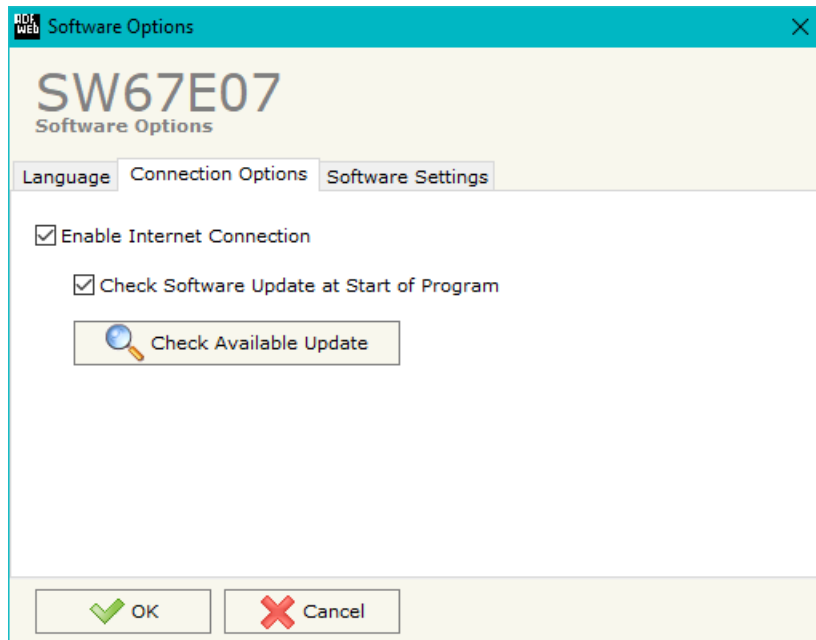

In the section “Connection Options”, it is possible to check if there are some updatings of the software compositor in ADFweb.com website. Checking the option “**Check Software Update at Start of Program**”, the SW67E07 checks automatically if there are updatings when it is launched.

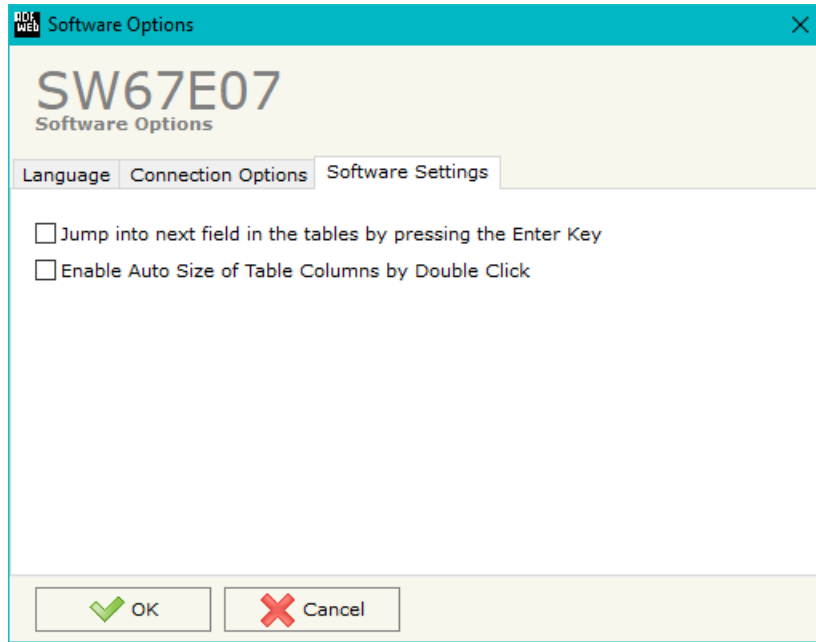

In the section "Software Settings", it is possible to enable/disable some keyboard's commands for an easier navigation inside the tables contained in the different sections of the software.



## SET COMMUNICATION:

This section define the fundamental communication parameters of two buses, EtherCAT and CAN.

By Pressing the **"Set Communication"** button from the main window for SW67E07 (Fig. 2) the window "Set Communication" appears (Fig. 3).

The means of the fields for "EtherCAT Slave" are:

- In the field **"Revision Number"** the revision number of the converter is defined;
- In the field **"Slave Name"** the name of the converter is defined;
- In the field **"Node Address"** the ID of the converter is defined.

The means for the fields for the "CAN" are:

- In the field **"Baudrate"** the baudrate of the CAN line is defined;

The means of the fields for "Ethernet" are:

- In the fields **"IP Address"** the IP address for Ethernet side of the converter is defined;
- In the fields **"SubNet Mask"** the SubNet Mask for Ethernet side of the converter is defined;
- In the fields **"Gateway"** the default gateway of the net is defined. This feature can be enabled or disabled pressing the Check Box field. This feature is used for going out of the net;
- In the fields **"DNS"** the IP address of the DNS server is defined

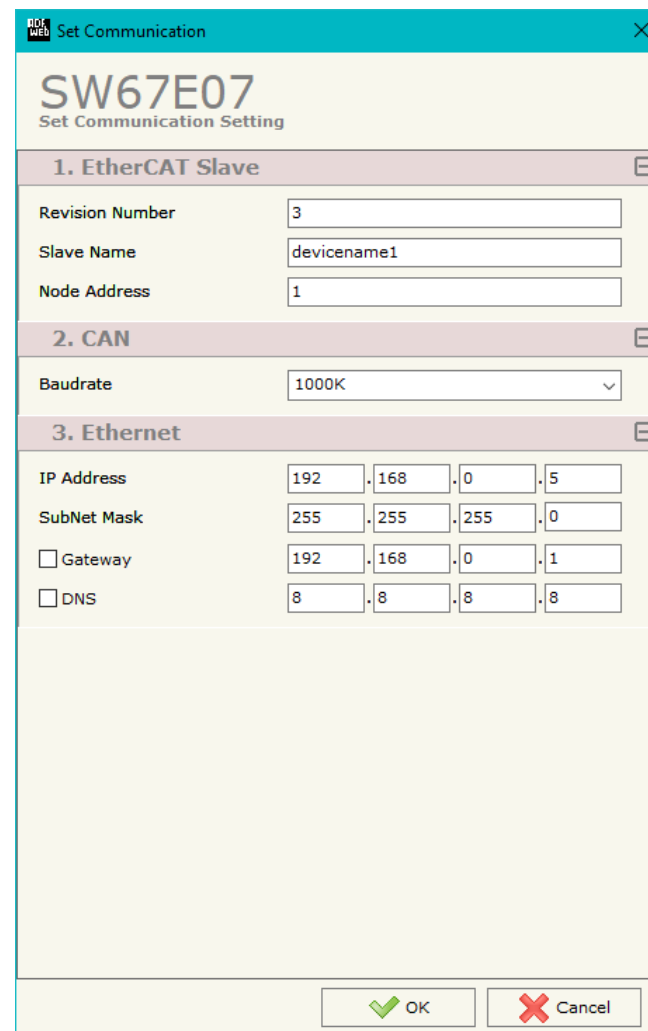

SW67E07 Set Communication Setting				
<b>1. EtherCAT Slave</b>				
Revision Number	<input type="text" value="3"/>			
Slave Name	<input type="text" value="devicename1"/>			
Node Address	<input type="text" value="1"/>			
<b>2. CAN</b>				
Baudrate	<input type="text" value="1000K"/>			
<b>3. Ethernet</b>				
IP Address	<input type="text" value="192"/>	<input type="text" value="168"/>	<input type="text" value="0"/>	<input type="text" value="5"/>
SubNet Mask	<input type="text" value="255"/>	<input type="text" value="255"/>	<input type="text" value="255"/>	<input type="text" value="0"/>
<input type="checkbox"/> Gateway	<input type="text" value="192"/>	<input type="text" value="168"/>	<input type="text" value="0"/>	<input type="text" value="1"/>
<input type="checkbox"/> DNS	<input type="text" value="8"/>	<input type="text" value="8"/>	<input type="text" value="8"/>	<input type="text" value="8"/>

Figure 3: "Set Communication" window

**ETHERCAT SET ACCESS:**

By Pressing the “**EtherCAT Set Access**” button from the main window for SW67E07 (Fig. 2) the window “EtherCAT Slave Set Access” appears (Fig. 4).

This section is used to define the EtherCAT variables readable by the EtherCAT Master (Slave To Master) and the EtherCAT variables writeable by the EtherCAT Master (Master To Slave).

**SLAVE TO MASTER**

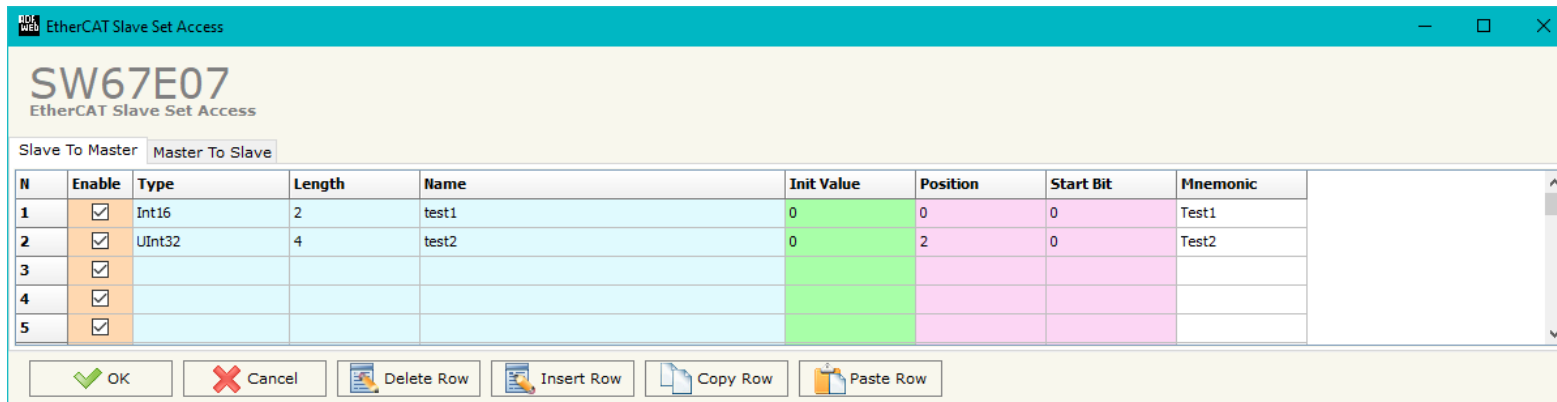

Figure 4a: “EtherCAT Slave Set Access → Slave To Master” window

The means of the fields are:

- If the field “**Enable**” is checked, the EtherCAT variable is enabled;
- In the field “**Type**” the data format of the EtherCAT variable is defined;
- In the field “**Length**” the dimension of the EtherCAT variable is defined;
- In the field “**Name**” the name of the EtherCAT variable is defined;
- In the field “**Init Value**” the default value of the EtherCAT variable is defined;
- In the field “**Position**” the starting address of the EtherCAT array where the variable is mapped is defined;
- In the field “**Start Bit**” the starting bit of the selected Position where the variable is mapped is defined;
- In the field “**Mnemonic**” a description of the variable is defined.

**MASTER TO SLAVE**

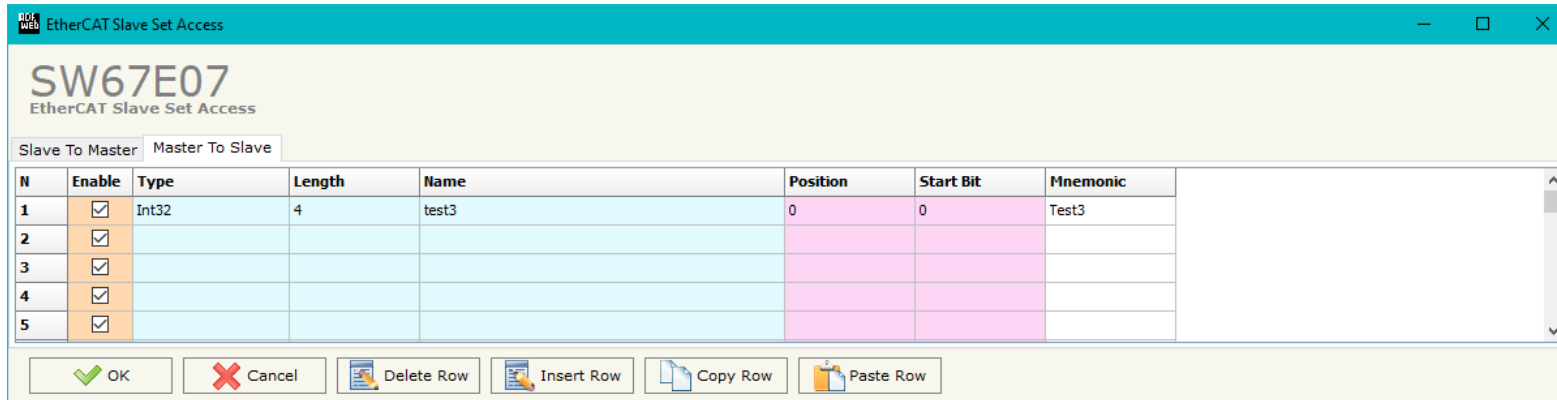

Figure 4b: "EtherCAT Slave Set Access → Master To Slave" window

The means of the fields are:

- If the field "**Enable**" is checked, the EtherCAT variable is enabled;
- In the field "**Type**" the data format of the EtherCAT variable is defined;
- In the field "**Length**" the dimension of the EtherCAT variable is defined;
- In the field "**Name**" the name of the EtherCAT variable is defined;
- In the field "**Position**" the starting address of the EtherCAT array where the variable is mapped is defined;
- In the field "**Start Bit**" the starting bit of the selected Position where the variable is mapped is defined;
- In the field "**Mnemonic**" a description of the variable is defined.

**RECEIVE FRAMES:**

By pressing the "Receive Frames" button from the main window for SW67E07 (Fig. 2) the "Receive CAN Frames" window appears (Fig. 5). The COB inserted in this table contains the data to write on EtherCAT side. These frames are accepted by the converter.

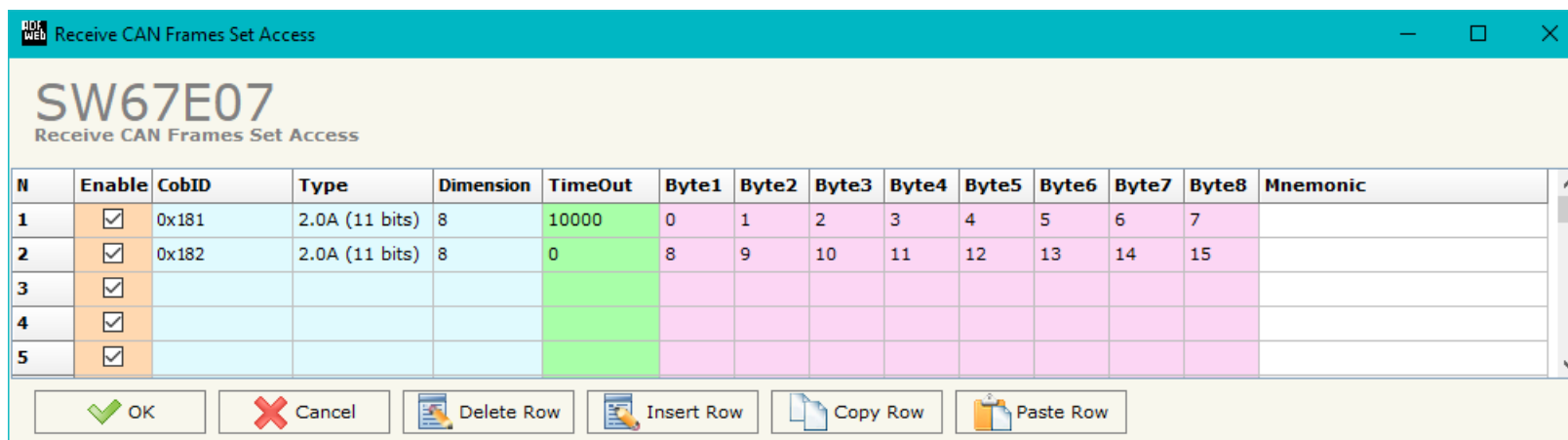

N	Enable	CobID	Type	Dimension	TimeOut	Byte1	Byte2	Byte3	Byte4	Byte5	Byte6	Byte7	Byte8	Mnemonic
1	<input checked="" type="checkbox"/>	0x181	2.0A (11 bits)	8	10000	0	1	2	3	4	5	6	7	
2	<input checked="" type="checkbox"/>	0x182	2.0A (11 bits)	8	0	8	9	10	11	12	13	14	15	
3	<input checked="" type="checkbox"/>													
4	<input checked="" type="checkbox"/>													
5	<input checked="" type="checkbox"/>													

Figure 5: "Receive CAN Frames Set Access" window

The data of the columns have the following meanings:

- If the field "Enable" is checked, the CAN frame is enabled;
- In the field "Cob-ID" the COB of the CAN frame is defined;
- In the field "Type" the type of CAN packet use for the Cob-ID is defined (2.0A (11 bits) or 2.0B (29 bits));
- In the field "Dimension" the number of byte of the COB (from 1 to 8) is defined;
- The field "TimeOut" is used for put at zero the data into EtherCAT array if the CAN frame arrives with a frequency less than the time expressed in the field. If the value in the field is '0', it means that you don't want to use this feature;
- In the field "Byte1" insert the byte of the EtherCAT array where saving 1st byte of the CAN message;
- In the field "Byte2" insert the byte of the EtherCAT array where saving 2nd byte of the CAN message;
- In the field "Byte3" insert the byte of the EtherCAT array where saving 3rd byte of the CAN message;
- In the field "Byte4" insert the byte of the EtherCAT array where saving 4th byte of the CAN message;
- In the field "Byte5" insert the byte of the EtherCAT array where saving 5th byte of the CAN message;
- In the field "Byte6" insert the byte of the EtherCAT array where saving 6th byte of the CAN message;

- In the field "**Byte7**" insert the byte of the EtherCAT array where saving 7th byte of the CAN message;
- In the field "**Byte8**" insert the byte of the EtherCAT array where saving 8th byte of the CAN message;
- In the field "**Mnemonic**" a brief description is defined.

**SEND FRAMES:**

By pressing the "Send Frames" button from the main window for SW67E07 (Fig. 2) the "Send CAN frames" window appears (Fig. 6). The COB inserted in this table contains the data received from EtherCAT side. These frames are sent by the converter.

N	Enable	CobID	Type	Dimension	OnChange	OnCMD	OnTimer	Time	Byte1	Byte2	Byte3	Byte4	Byte5	Byte6	Byte7	Byte8	Mnemonic
1	<input checked="" type="checkbox"/>	0x201	2.0A (11 bits)	8	<input checked="" type="checkbox"/>	<input checked="" type="checkbox"/>	<input checked="" type="checkbox"/>	1000	0	1	2	3	4	5	6	7	
2	<input checked="" type="checkbox"/>	0x202	2.0A (11 bits)	8	<input type="checkbox"/>	<input type="checkbox"/>	<input checked="" type="checkbox"/>	2000	8	9	10	11	12	13	14	15	
3	<input checked="" type="checkbox"/>				<input type="checkbox"/>	<input type="checkbox"/>	<input type="checkbox"/>										
4	<input checked="" type="checkbox"/>				<input type="checkbox"/>	<input type="checkbox"/>	<input type="checkbox"/>										
5	<input checked="" type="checkbox"/>				<input type="checkbox"/>	<input type="checkbox"/>	<input type="checkbox"/>										

Figure 6: "Transmit CAN Frames Set Access" window

The data of the columns have the following meanings:

- If the field "Enable" is checked, the CAN frame is enabled;
- In the field "Cob-ID" the COB of the CAN frame is defined;
- In the field "Type" the type of CAN packet use for this Cob-ID is defined (2.0A (11 bits) or 2.0B (29 bits));
- In the field "Dimension" the number of byte of the COB (from 1 to 8) is defined;
- If the field "OnChange" is checked, the frame is sent when the data from EtherCAT change;
- If the field "OnCMD" is checked, the frame is sent when a EtherCAT message is received;
- If the field "OnTimer" is checked, the frame is sent cyclically with the delay defined in the field "Time" (expressed in ms);
- In the field "Byte1" insert the byte of the EtherCAT array where taking 1st byte of the CAN message;
- In the field "Byte2" insert the byte of the EtherCAT array where taking 2nd byte of the CAN message;
- In the field "Byte3" insert the byte of the EtherCAT array where taking 3rd byte of the CAN message;
- In the field "Byte4" insert the byte of the EtherCAT array where taking 4th byte of the CAN message;

- In the field "**Byte5**" insert the byte of the EtherCAT array where taking 5th byte of the CAN message;
- In the field "**Byte6**" insert the byte of the EtherCAT array where taking 6th byte of the CAN message;
- In the field "**Byte7**" insert the byte of the EtherCAT array where taking 7th byte of the CAN message;
- In the field "**Byte8**" insert the byte of the EtherCAT array where taking 8th byte of the CAN message;
- In the field "**Mnemonic**" it is possible to insert a brief description.

#### **ETHERCAT ESI FILE:**

By pressing the "**EtherCAT ESI File**" button it is possible to save the ESI file for the EtherCAT side of the converter. The ESI file is used to configure the EtherCAT Master.

### UPDATE DEVICE:

By pressing the **“Update Device”** button, it is possible to load the created Configuration into the device; and also the Firmware, if necessary. This by using the Ethernet port.

If you don't know the actual IP address of the device you have to use this procedure:

- Turn OFF the Device;
- Put Dip1 of 'Dip-Switch A' in ON position;
- Turn ON the device
- Connect the Ethernet cable;
- Insert the IP **“192.168.2.205”**;
- Select which operations you want to do;
- Press the **“Execute update firmware”** button to start the upload;
- When all the operations are “OK” turn OFF the Device;
- Put Dip1 of 'Dip-Switch A' in OFF position;
- Turn ON the device.

If you know the actual IP address of the device, you have to use this procedure:

- Turn ON the Device with the Ethernet cable inserted;
- Insert the actual IP of the Converter;
- Select which operations you want to do;
- Press the **“Execute update firmware”** button to start the upload;
- When all the operations are “OK” the device automatically goes at Normal Mode.

At this point the configuration/firmware on the device is correctly updated.

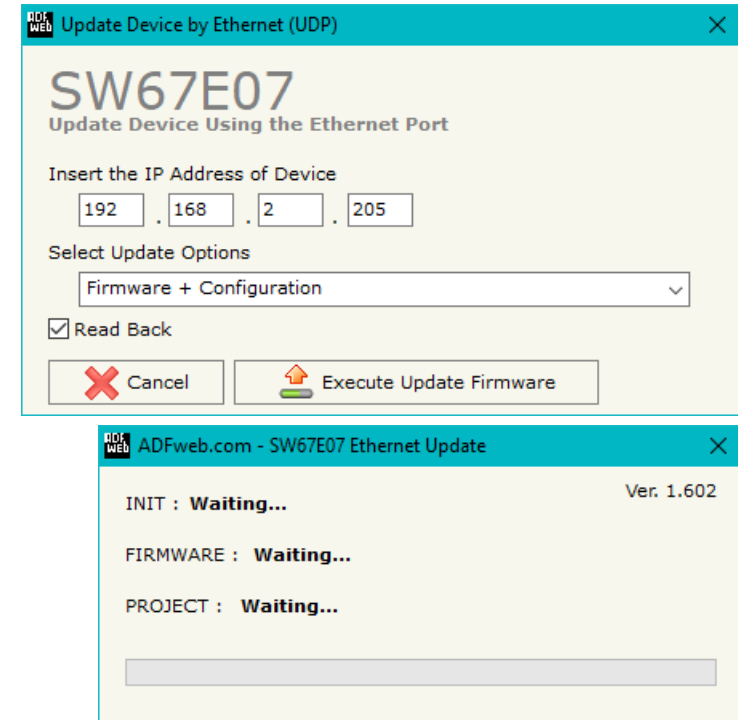

Figure 7: “Update device” windows





**Note:**

When you receive the device, for the first time, you also have to update the Firmware in the HD67E07 device.



**Warning:**

If Fig. 8 appears when you try to do the Update try these points before seeking assistance:

- Try to repeat the operations for the updating;
- Try with another PC;
- Try to restart the PC;
- Check the LAN settings;
- If you are using the program inside a Virtual Machine, try to use in the main Operating System;
- If you are using Windows Seven, Vista, 8 or 10 make sure that you have the administrator privileges;
- In case you have to program more than one device, using the "UDP Update", you have to cancel the ARP table every time you connect a new device on Ethernet. For do this you have to launch the "Command Prompt" and write the command "arp -d". Pay attention that with Windows Vista, Seven, 8, 10 you have to launch the "Command Prompt" with Administrator Rights;
- Pay attention at Firewall lock.

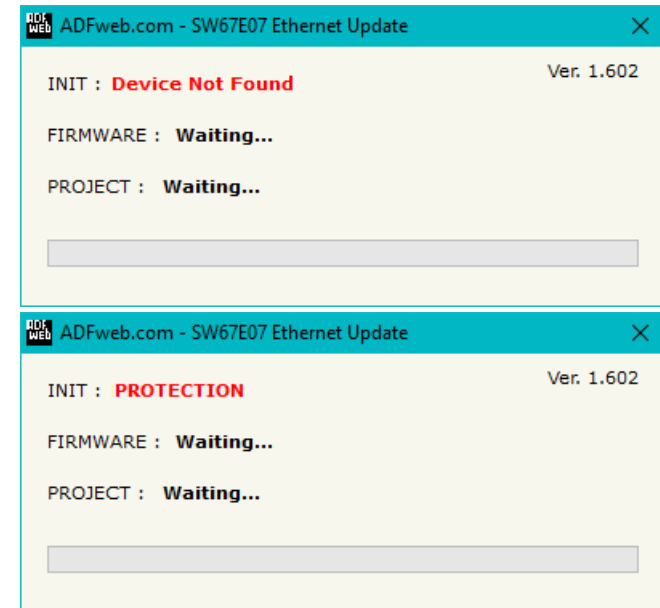

Figure 8: "Error" window



**Warning:**

In the case of HD67E07 you have to use the software "HD67E07": [www.adfweb.com/download/filefold/SW67E07.zip](http://www.adfweb.com/download/filefold/SW67E07.zip).

**MECHANICAL DIMENSIONS:**

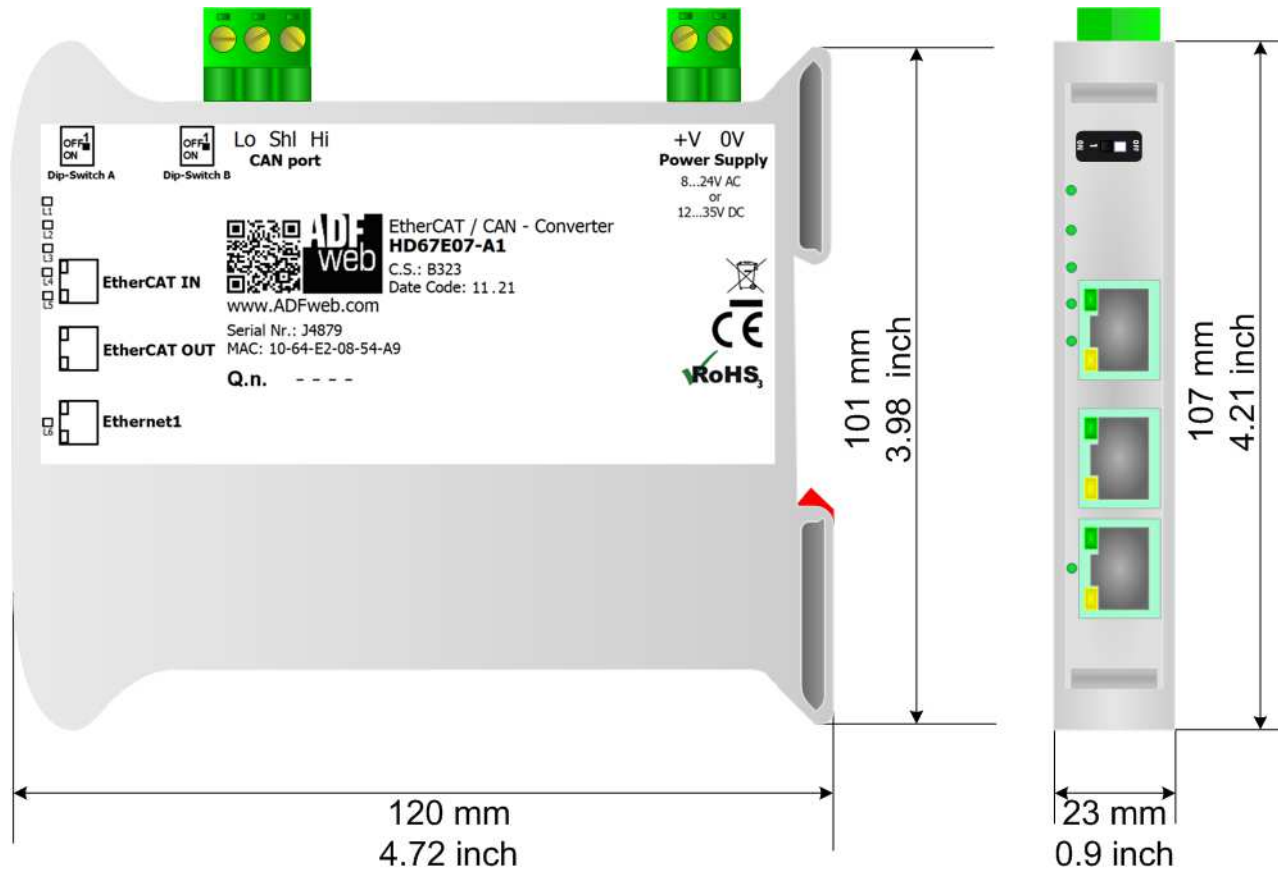

Housing: PVC  
 Weight: 200g (Approx)

Figure 9: Mechanical dimensions scheme for HD67E07-A1

**ORDERING INFORMATIONS:**

The ordering part number is formed by a valid combination of the following:

**HD67E07 - xx**

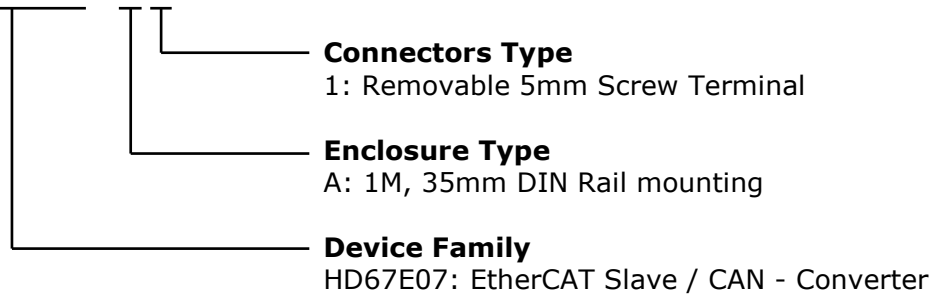

Order Code: **HD67E07-A1** - EtherCAT Slave / CAN - Converter

**ACCESSORIES:**

Order Code: **AC34011** - 35mm Rail DIN - Power Supply 220/240V AC 50/60Hz - 12 V DC

Order Code: **AC34012** - 35mm Rail DIN - Power Supply 220/240V AC 50/60Hz - 24 V DC

**DISCLAIMER:**

All technical content within this document can be modified without notice. The content of the document is a under continual renewal. For losses due to fire, earthquake, third party access or other accidents, or intentional or accidental abuse, misuse, or use under abnormal conditions repairs are charged to the user. ADFweb.com S.r.l. will not be liable for accidental loss of use or inability to use this product, such as loss of business income. ADFweb.com S.r.l. shall not be liable for consequences of improper use.

**OTHER REGULATIONS AND STANDARDS:****WEEE INFORMATION**

Disposal of old electrical and electronic equipment (as in the European Union and other European countries with separate collection systems).

— This symbol on the product or on its packaging indicates that this product may not be treated as household rubbish. Instead, it should be taken to an applicable collection point for the recycling of electrical and electronic equipment. If the product is disposed correctly, you will help prevent potential negative environmental factors and impact of human health, which could otherwise be caused by inappropriate disposal. The recycling of materials will help to conserve natural resources. For more information about recycling this product, please contact your local city office, your household waste disposal service or the shop where you purchased the product.

**RESTRICTION OF HAZARDOUS SUBSTANCES DIRECTIVE**

The device respects the 2002/95/EC Directive on the restriction of the use of certain hazardous substances in electrical and electronic equipment (commonly referred to as Restriction of Hazardous Substances Directive or RoHS).

**CE MARKING**

The product conforms with the essential requirements of the applicable EC directives.

**WARRANTIES AND TECHNICAL SUPPORT:**

For fast and easy technical support for your ADFweb.com SRL products, consult our internet support at [www.adfweb.com](http://www.adfweb.com). Otherwise contact us at the address [support@adfweb.com](mailto:support@adfweb.com)

**RETURN POLICY:**

If while using your product you have any problem and you wish to exchange or repair it, please do the following:

- Obtain a Product Return Number (PRN) from our internet support at [www.adfweb.com](http://www.adfweb.com). Together with the request, you need to provide detailed information about the problem.
- Send the product to the address provided with the PRN, having prepaid the shipping costs (shipment costs billed to us will not be accepted).

If the product is within the warranty of twelve months, it will be repaired or exchanged and returned within three weeks. If the product is no longer under warranty, you will receive a repair estimate.



**ADFweb.com S.r.l.**  
Via Strada Nuova, 17  
IT-31010 Mareno di Piave  
TREVISO (Italy)  
Phone +39.0438.30.91.31  
Fax +39.0438.49.20.99  
[www.adfweb.com](http://www.adfweb.com)

